

PREFACE

This draft document was prepared by technical staff of the State Water Resources Control Board (State Board) and is subject to the Board's review. The wording of this Plan is presented in a format for Board adoption, rather than being phrased as a staff recommendation to the Board. This Plan does not reflect a position by the Board. Board members have worked with staff in reviewing the contents of the Plan. However, the Board's decision will be based upon the public's comments on this Plan as presented in Phase II as well as the evidence already given in Phase I of the hearing.

Tim Stoshane
November 1988

CITING INFORMATION

When citing evidence in the hearing record, the following conventions have been adopted:

Information derived from the transcript:

T, XIX, 123:09-125:20

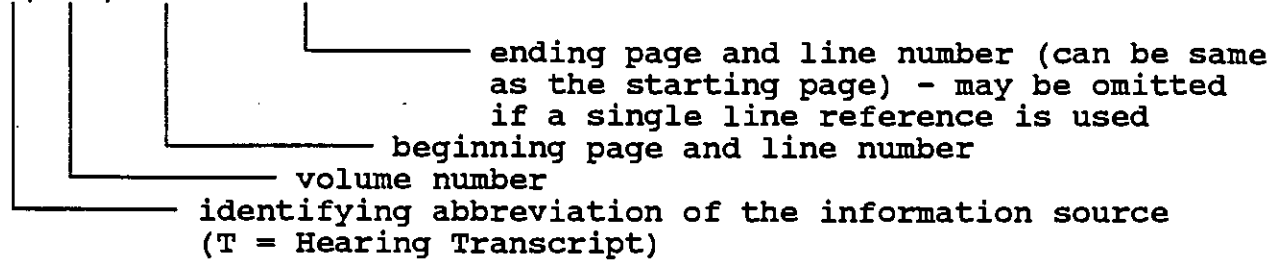

Information derived from an exhibit:

SWRCB, 25, 45

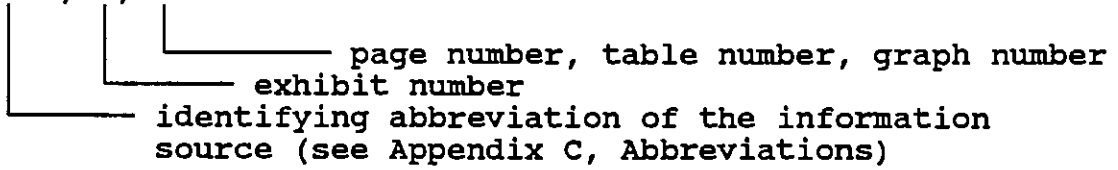

When citing references outside of the hearing record, the following conventions have been adopted:

Information derived from published documents, (a) in the text of the Plan:

Denton, R.A., 1985

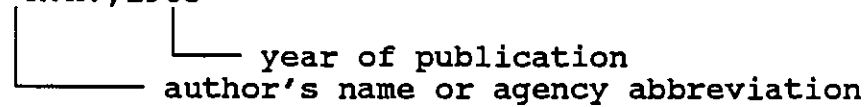

(b) at the end of the appropriate Plan Chapter:

Denton, R.A., Currents in Suisun Bay, January 1985, pg. 4.

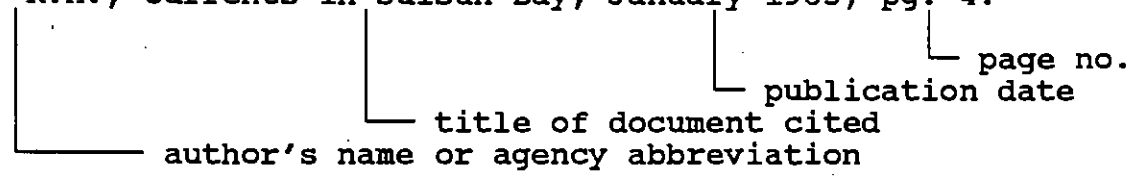

CITING INFORMATION (Continued)

Information derived from Phase I closing briefs,
 (a) in the text of the Plan:

RIC, Brief, 8

_____ page number
 _____ "Brief"
 _____ identifying abbreviation of the information source

(b) at the end of the appropriate Plan Chapter:

Brief of the Rice Industry Committee on Pollutants in the Bay-Delta Estuary, pg. 8.

For a complete list of the abbreviations for information sources, citations and symbols used in this document, see Appendix C.

Appendix D is a Glossary of Terms.

WATER QUALITY CONTROL PLAN FOR SALINITY
SAN FRANCISCO BAY/SACRAMENTO-SAN JOAQUIN DELTA ESTUARY

CONTENTS

| | |
|---|------|
| Preface..... | i |
| Citing Information..... | ii |
| Contents..... | iv |
| List of Figures..... | viii |
| List of Tables..... | xi |
| List of Appendices..... | xiv |
| | |
| 1.0 <u>EXECUTIVE SUMMARY</u> | |
| 1.1 Background..... | 1-1 |
| 1.2 Hearing Process..... | 1-1 |
| 1.3 Purpose and Current Context of the Plan..... | 1-2 |
| 1.4 Structure of the Plan..... | 1-2 |
| 1.4.1 Chapter 1--Executive Summary..... | 1-2 |
| 1.4.2 Chapter 2--Scope of the Plan..... | 1-2 |
| 1.4.3 Chapter 3--Basin Description..... | 1-3 |
| 1.4.4 Chapter 4--Beneficial Uses..... | 1-4 |
| 1.4.5 Chapter 5--Optimal Levels of Protection..... | 1-4 |
| 1.4.6 Chapter 6--Reasonable Demands for Consumptive Use of Bay-Delta Waters..... | 1-4 |
| 1.4.7 Chapter 7--The Development of Reasonable Alternative Water Quality Control Objectives..... | 1-5 |
| 1.4.8 Chapter 8--Program of Implementation..... | 1-5 |
| 1.5 Concerns..... | 1-5 |
| 1.6 California Water Ethic..... | 1-6 |
| 1.7 Principles Guiding the Development of Water Quality Objectives..... | 1-7 |
| 1.8 Recommendations..... | 1-8 |
| 1.9 Implementation..... | 1-10 |
| 1.10 Water Supply Impacts..... | 1-10 |
| | |
| 2.0 <u>SCOPE OF THE PLAN</u> | |
| 2.1 Introduction..... | 2-1 |
| 2.2 Purpose of the Plan..... | 2-1 |
| 2.3 Authority for Regulation of Water Quality in the Bay-Delta Estuary..... | 2-2 |
| 2.4 Geographic Limits..... | 2-3 |
| 2.4.1 San Francisco Bay..... | 2-3 |
| 2.4.2 Sacramento-San Joaquin Delta..... | 2-4 |
| 2.4.3 Suisun Marsh..... | 2-4 |
| 2.5 Pollutants in the Bay-Delta Estuary..... | 2-4 |
| 2.6 California Environmental Quality Act (CEQA)..... | 2-4 |
| | |
| 3.0 <u>BASIN DESCRIPTION</u> | |
| 3.1 Introduction..... | 3-1 |
| 3.1.1 Unimpaired Flow Conditions..... | 3-1 |
| 3.1.2 Current Flow Conditions..... | 3-5 |
| 3.1.3 Water Year Types..... | 3-5 |
| 3.2 Sacramento River Basin..... | 3-17 |
| 3.2.1 Physical Description..... | 3-17 |

Chapters (continued)

| | | |
|-------|---|------|
| 3.2.2 | Hydrology..... | 3-19 |
| 3.2.3 | Unimpaired Flow Conditions..... | 3-19 |
| 3.2.4 | Current Flow Conditions..... | 3-19 |
| 3.3 | Central Sierra Basin..... | 3-22 |
| 3.3.1 | Physical Description..... | 3-22 |
| 3.3.2 | Hydrology..... | 3-22 |
| 3.3.3 | Unimpaired Flow Conditions..... | 3-23 |
| 3.3.4 | Current Flow Conditions..... | 3-23 |
| 3.4 | San Joaquin River Basin..... | 3-23 |
| 3.4.1 | Physical Description..... | 3-23 |
| 3.4.2 | Hydrology..... | 3-24 |
| 3.4.3 | Unimpaired Flow Conditions..... | 3-24 |
| 3.4.4 | Current Flow Conditions..... | 3-27 |
| 3.5 | The Delta..... | 3-27 |
| 3.5.1 | Physical Description..... | 3-27 |
| 3.5.2 | Hydrology..... | 3-30 |
| 3.5.3 | Unimpaired Flow Conditions..... | 3-41 |
| 3.5.4 | Current Flow Conditions..... | 3-45 |
| 3.6 | San Francisco Bay and Basin..... | 3-45 |
| 3.6.1 | Physical Description: San Francisco Bay..... | 3-45 |
| 3.6.2 | Physical Description: San Francisco Bay Basin..... | 3-50 |
| 3.6.3 | Hydrology: San Francisco Bay..... | 3-50 |
| 3.6.4 | Hydrology: San Francisco Bay Basin..... | 3-59 |
| 3.6.5 | Unimpaired Flow Conditions: San Francisco Bay..... | 3-61 |
| 3.6.6 | Unimpaired Flow Conditions: San Francisco Bay Basin..... | 3-61 |
| 3.6.7 | Current Flow Conditions: San Francisco Bay..... | 3-61 |
| 3.6.8 | Current Flow Conditions: San Francisco Bay Basin.. | 3-61 |
| 4.0 | <u>BENEFICIAL USES OF BAY-DELTA ESTUARY WATER</u> | |
| 4.1 | Introduction..... | 4-1 |
| 4.2 | Estuary Water for Municipal and Domestic Supply Purposes..... | 4-1 |
| 4.3 | Industrial Beneficial Uses..... | 4-3 |
| 4.3.1 | Industrial Use Comprises Three Separate Beneficial Uses..... | 4-3 |
| 4.3.2 | Antioch-Pittsburg Area..... | 4-3 |
| 4.3.3 | Other Industries..... | 4-5 |
| 4.4 | Estuary Agriculture Beneficial Uses..... | 4-6 |
| 4.4.1 | Delta Agriculture..... | 4-6 |
| 4.4.2 | Bay Agriculture..... | 4-11 |
| 4.5 | Estuary Fishery Habitat Beneficial Uses..... | 4-11 |
| 4.5.1 | Delta Habitat..... | 4-12 |
| 4.5.2 | Bay Habitat..... | 4-42 |
| 4.5.3 | Ocean Habitat..... | 4-54 |
| 4.6 | Estuary Wildlife Habitat Beneficial Use..... | 4-55 |
| 4.6.1 | Delta..... | 4-55 |
| 4.6.2 | Suisun Marsh..... | 4-56 |
| 4.6.3 | Other Tidal Marshes..... | 4-56 |
| 4.7 | Estuary Recreation Beneficial Use..... | 4-57 |
| 4.7.1 | Sacramento-San Joaquin Delta and Tributaries..... | 4-57 |
| 4.7.2 | Suisun Marsh and Carquinez Straits Area..... | 4-58 |
| 4.7.3 | San Francisco Bay and Adjacent Ocean..... | 4-59 |
| 4.8 | Other Beneficial Uses..... | 4-59 |
| 4.8.1 | Navigation..... | 4-59 |

Chapters (continued)

| | | |
|-------|--|-------|
| 4.8.2 | Dilution of Pollutants..... | 4-60 |
| 4.9 | Uses of Water Exported from the Bay-Delta Estuary..... | 4-60 |
| 4.9.1 | Municipal and Industrial Uses..... | 4-61 |
| 4.9.2 | Agriculture..... | 4-66 |
| 4.9.3 | Fishery Habitat..... | 4-69 |
| 4.9.4 | Export Wildlife Use..... | 4-71 |
| 4.9.5 | Export Recreation..... | 4-72 |
| 5.0 | <u>OPTIMAL LEVELS OF PROTECTION FOR BENEFICIAL USES OF BAY-DELTA ESTUARY WATER</u> | |
| 5.1 | Introduction..... | 5-1 |
| 5.2 | Hydrologic Considerations..... | 5-2 |
| 5.3 | Determining the Optimal Level of Protection for Beneficial Uses..... | 5-3 |
| 5.3.1 | Municipal and Industrial..... | 5-3 |
| 5.3.2 | (Not Used) | |
| 5.3.3 | Agriculture..... | 5-8 |
| 5.3.4 | Chinook Salmon..... | 5-25 |
| 5.3.5 | Striped Bass..... | 5-68 |
| 5.3.6 | No Action Alternative..... | 5-89 |
| 5.3.7 | Suisun Marsh Wildlife Habitat Beneficial Use Alternative..... | 5-96 |
| 5.3.8 | Other (i.e., Navigation/Recreation)..... | 5-104 |
| 6.0 | <u>DETERMINATION OF REASONABLE NEEDS FOR CONSUMPTIVE USES OF BAY-DELTA WATERS</u> | |
| 6.1 | California Water Ethic..... | 6-1 |
| 6.1.1 | Balancing..... | 6-1 |
| 6.1.2 | Actions Needed..... | 6-2 |
| 6.2 | Reasonable Needs for Consumptive Uses..... | 6-2 |
| 6.2.1 | Reasonable Consumptive Agricultural Needs..... | 6-3 |
| 6.2.2 | Reasonable Consumptive Municipal and Industrial Needs..... | 6-6 |
| 6.2.3 | Southern California Water Balance..... | 6-11 |
| 6.2.4 | Method to Increase April through July Net Delta Outflow..... | 6-14 |
| 7.0 | <u>WATER QUALITY OBJECTIVES</u> | |
| 7.1 | Introduction..... | 7-1 |
| 7.2 | Alternate Levels of Protection for Each Beneficial Use | 7-1 |
| 7.2.1 | Municipal and Industrial..... | 7-1 |
| 7.2.2 | Agriculture..... | 7-4 |
| 7.2.3 | Delta Fisheries and Estuarine Habitat..... | 7-6 |
| 7.3 | Development of Alternative Objectives..... | 7-20 |
| 7.3.1 | Effects on Water Availability..... | 7-20 |
| 7.3.2 | Evaluation of Alternative Plans..... | 7-27 |
| 8.0 | <u>PROGRAM OF IMPLEMENTATION</u> | |
| 8.1 | Introduction and Discussion of Issues..... | 8-1 |
| 8.1.1 | Water Right Issues..... | 8-1 |
| 8.1.2 | Water Quality Issues..... | 8-2 |
| 8.2 | Monitoring and Special Studies..... | 8-3 |
| 8.2.1 | Compliance Monitoring..... | 8-4 |

Chapters (continued)

| | |
|---|-----|
| 8.2.2 Baseline and Special Studies..... | 8-4 |
| 8.2 Legislative Proposals..... | 8-5 |
| 8.4 Time Schedule..... | 8-5 |

FIGURES

| | | |
|-----------|--|------|
| 1 | Sacramento River Basin, April through July Hydrologic Classification..... | 1-12 |
| 2 | San Joaquin River Basin, April through July Hydrologic Classification..... | 1-13 |
| 3 | Striped Bass Index, Sacramento Natural Salmon Population and Total Delta Exports..... | 1-14 |
| 4 | Recommended Plan Water Supply Impacts, 1922-78 Hydrology Under the Present Level of Development..... | 1-15 |
| 5 | Recommended Plan Water Supply Impacts, 1972-87 (W/O 1983) Historic Hydrology..... | 1-16 |
| 3.1-1 | Boundary of the Bay-Delta Estuary and Locations of Diversion Points (From:SWRCB,3,5)..... | 3-2 |
| 3.1-2 | Boundaries of the Sacramento River (5A), Central Sierra and Delta (5B), and San Joaquin (5C) Basins (From:RWQCB 5, 1975)..... | 3-3 |
| 3.1-3 | Boundary of the San Francisco Bay Basin (From:SWRCB,3,12)..... | 3-4 |
| 3.1.3.2-1 | Water Quality Control Plan Hydrologic Classification..... | 3-6 |
| 3.1.3.3-1 | Sacramento River Basin April through July Classification..... | 3-8 |
| 3.1.3.3-2 | San Joaquin River Basin April through July Classification..... | 3-9 |
| 3.1.3.3-3 | Estimated Water Year and April through July Unimpaired Flow for the Sacramento and San Joaquin Valleys, 1906-1987..... | 3-10 |
| 3.2.2-1 | Interbasin Water Transfers for a 1980 Level of Development and the Annual Amounts in AF/yr (From:DWR, 19)..... | 3-20 |
| 3.2.3-1 | Sacramento Valley Average Monthly Flow 1922 through 1978..... | 3-21 |
| 3.4.3-1 | San Joaquin Valley Average Monthly Flow 1922 through 1978..... | 3-25 |
| 3.4.3-2 | Unimpaired Flows Versus Measured Flows for the San Joaquin Basin..... | 3-26 |
| 3.4.4-1 | Salinity, Flow and Salt Load in the San Joaquin River Near Vernalis (5 Year Running Averages)..... | 3-28 |
| 3.5.2.3-1 | Means and Standard Deviations of Net Monthly Discharges of the Sacramento-San Joaquin Delta Into San Francisco Bay at Chipps Island, 1956-1985 from Estimates of the State of California (1986)..... | 3-32 |
| 3.5.2.4-1 | Location Map Irrigation Diversion Points..... | 3-34 |
| 3.5.2.4-2 | Location Map Agricultural Drainage Return Points. | 3-35 |
| 3.5.2.4-3 | Delta Circulation Patterns High Flows, High Exports..... | 3-36 |
| 3.5.2.4-4 | Delta Circulation Patterns Low Flows, High Export..... | 3-37 |

Figures (continued)

| | | |
|-----------|--|------|
| 3.5.2.4-5 | Delta Circulation Patterns High Flows, No Export..... | 3-38 |
| 3.5.2.4-6 | Delta Circulation Patterns Low Flows, No Export..... | 3-39 |
| 3.5.2.4-7 | Delta Circulation Patterns Low Flows, Low Export..... | 3-40 |
| 3.5.2.5-1 | Salinity-Outflow Relationship at Collinsville Monthly Mean of Daily High and Daily Mean EC..... | 3-42 |
| 3.5.2.5-2 | Maximum Salinity Intrusion 1920-1977 Sacramento-San Joaquin Delta..... | 3-43 |
| 3.5.3-1 | Average Monthly Delta Outflow..... | 3-44 |
| 3.5.4-1 | Current and Unimpaired Delta Outflow..... | 3-47 |
| 3.5.4-2 | Unimpaired Delta Outflow..... | 3-48 |
| 3.5.4-3 | Minimum D-1485 Required Delta Outflow..... | 3-49 |
| 3.6.2.1-1 | Location Map of the San Francisco Bay Showing the Four Sub-Regions and the Sacramento- San Joaquin Delta..... | 3-51 |
| 3.6.2.1-2 | Map of the Central Bay and the Region Immediately Outside Golden Gate..... | 3-54 |
| 3.6.2.1-3 | Map of San Pablo Bay..... | 3-55 |
| 3.6.2.1-4 | Map of Suisun Bay..... | 3-57 |
| 3.6.2.1-5 | Diagram of Estuarine Circulation for a Partially Mixed Estuary..... | 3-58 |
| 3.6.2.1-6 | Map of the South Bay..... | 3-60 |
| 3.6.3.2-1 | Average Inflow from the Delta Compared with Average Local Bay Inflow..... | 3-63 |
| 3.6.3.2-2 | Golden Gate Tidal Exchange Volume Compared with Freshwater Inflow During a Flood Tide with a 24 Percent Tidal Exchange..... | 3-63 |
| 4.5.1.2-1 | Timing of Life History Stages for the Four Races of Chinook Salmon in the Sacramento River Basin.. | 4-15 |
| 4.5.1.2-2 | Spawning Escapement of the Four Races of Chinook Salmon in the Upper Sacramento River Basin..... | 4-16 |
| 4.5.1.2-3 | Mean Monthly Salvage of Chinook Salmon at the State Water Project Fish Protective Facility, 1968-1986..... | 4-20 |
| 4.5.1.2-4 | Total Sacramento Basin Fall Run Spawning Chinook Salmon..... | 4-21 |
| 4.5.1.2-5 | Estimated Ocean Harvest Fraction for California Chinook Salmon..... | 4-23 |
| 4.5.1.2-6 | Estimates of Annual Ocean Harvest of Central Valley Chinook Salmon..... | 4-24 |
| 4.5.1.2-7 | Comparison of Total Spawning Escapement of Sacramento and San Joaquin River Basin Chinook Salmon, 1953-1986..... | 4-25 |
| 4.5.1.4-1 | Relationship Between Average Daily April-June Inflow to the Delta and Fall Abundance of Juvenile American Shad, 1967-1985 (Except 1974 and 1979).. | 4-33 |
| 4.5.2.3-1 | Average Monthly Outflow at Chipps Island, 1980-1985..... | 4-50 |
| 4.9.3-1 | State Water Project Recreation Developments..... | 4-70 |
| 5.3.3.4-1 | Sacramento River at Emmaton Monthly Mean Salinity of Year Types..... | 5-19 |

Figures (continued)

| | | |
|------------|---|------|
| 5.3.3.4-2 | San Joaquin River at Jersey Point Monthly Mean Salinity of Year Types..... | 5-19 |
| 5.3.3.4-3 | Mokelumne River at Terminous Salinity of Year Types..... | 5-20 |
| 5.3.3.4-4 | San Joaquin River at San Andreas Landing Monthly Mean Salinity of Year Types..... | 5-20 |
| 5.3.3.4-5 | Cache Slough Near Junction Point Monthly Mean Salinity of Year Types..... | 5-21 |
| 5.3.3.4-6 | San Joaquin River at Vernalis Monthly Mean Salinity of Year Types..... | 5-22 |
| 5.3.3.4-7 | San Joaquin River at Mossdale Monthly Mean Salinity of Year Types..... | 5-22 |
| 5.3.3.4-8 | Bifurcation of Old and Middle River Monthly Mean Salinity of Year Types..... | 5-23 |
| 5.3.3.4-9 | San Joaquin River at Brandt Bridge Monthly Mean Salinity of Year Types..... | 5-23 |
| 5.3.3.4-10 | Middle River at Howard Road Bridge Monthly Mean Salinity of Year Types..... | 5-24 |
| 5.3.3.4-11 | Old River at Tracy Road Bridge Monthly Mean Salinity of Year Types..... | 5-24 |
| 5.3.4.1-1 | Schematic Representation of the Delta and Experimental Smolt Release Sites..... | 5-28 |
| 5.3.4.1-2 | Relationship Between Delta Exports and Flows in the San Joaquin River..... | 5-29 |
| 5.3.4.3-1 | Change in Delta Inflows From Unimpaired Conditions..... | 5-43 |
| 5.3.4.3-2 | Relationship of Smolt Survival Through the Delta to Mean Daily Rio Vista Flow Based on Ocean Recovery of Tagged Hatchery Smolts..... | 5-45 |
| 5.3.4.3-3 | Comparison of Mean Monthly Smolt Survival for 1978 Delta Plan Controlling Flows Versus Weighted Monthly Smolt Survival Based on Actual Rio Vista Flows and Percent Smolts Passing Chipps Island, 1978-1986..... | 5-48 |
| 5.3.4.3-4 | Mean April Through June San Joaquin River Flows at Vernalis During Smolt Emigration and Subsequent Adult Escapement 2 1/2 Years Later..... | 5-51 |
| 5.3.4.3-5 | Relationship Between Mean April Through June Flows at Vernalis and Adult Spawning Escapement 2 1/2 Years Later, 1956-1984..... | 5-52 |
| 5.3.4.3-6 | Mean April to June Flows at Vernalis and the Corresponding Estimated Smolt Survival Index for Marked Smolt..... | 5-53 |
| 5.3.4.3-7 | Empirical Relationships Between Flows in Georgiana Slough, Delta Cross Channel and the Sacramento River..... | 5-55 |
| 5.3.4.3-8 | Delta Smolt Survival (Based on Ocean Tag Recoveries of Marked Salmon) Versus Percent Diverted Off the Sacramento River into the Cross Channel and Georgiana Slough at Walnut Grove During the Time the Marked Fish Were Migrating Downstream..... | 5-57 |
| 5.3.4.3-9 | Mean Survival of Tagged Smolts Released at Different Locations and Recovered at Chipps Island..... | 5-59 |

Figures (continued)

| | | |
|------------|---|------|
| 5.3.4.3-10 | Comparison of Mean April-June Delta Exports and Inflows at Vernalis, 1956-1987..... | 5-62 |
| 5.3.4.3-11 | Change in Mean Monthly Annual Delta Exports and Estimated Chinook Salmon Losses, 1956-1986..... | 5-63 |
| 5.3.4.3-12 | Relationship Between Mean Water Temperatures and Survival of Marked Smolts Between Sacramento and Suisun Bay..... | 5-66 |
| 5.3.5.1-1 | Striped Bass Index..... | 5-75 |
| 5.3.5.1-2 | Delta Striped Bass Index as Percent of Total Actual Striped Bass Index..... | 5-76 |
| 5.3.5.3-1 | Total Delta Exports..... | 5-80 |
| 7.2.3.1-1 | Average April-June Flows for Selected Historical Periods Providing Different Levels of Protection for Salmon..... | 7-9 |
| 7.2.3.1-2 | Striped Bass Index, Sacramento/San Joaquin Natural Salmon Population and Total Delta Exports..... | 7-12 |
| 7.3.1.3-1 | Delta Hydrologic Scheme Used in the Water Supply Impact Analysis..... | 7-24 |
| 7.3.2.7-1 | Recommended Plan Water Supply Impacts - 1922-1978 Hydrology Under the Present Level-of-Development. | 7-34 |
| 7.3.2.7-2 | Recommended Plan Water Supply Impacts - 1972-1978 (W/O 1983) Historic Hydrology..... | 7-35 |

TABLES.

| | | |
|-----------|---|------|
| 1 | Recommended Water Quality Objectives..... | 1-17 |
| 3.1.3.4-1 | Sacramento River Basin Four River Index and Hydrologic Classifications..... | 3-12 |
| 3.1.3.4-2 | San Joaquin River Four River Index and Hydrologic Classifications..... | 3-14 |
| 3.1.3.4-3 | Decision 1485 Water Year Classification for the Sacramento River Basin: Number and Percentage of Occurrences..... | 3-16 |
| 3.1.3.4-4 | Water Year and April Through July Classification: Frequencies of Occurrence for the Sacramento Basin | 3-17 |
| 3.1.3.4-5 | Water Year and April Through July Classification: Frequencies of Occurrence for the Sacramento River Basin..... | 3-17 |
| 3.1.3.4-6 | Proposed and 1978 WQCP Hydrologic Classifications Number and Frequencies of Occurrence (1906 through 1987)..... | 3-18 |
| 3.2.4-1 | Sacramento River Basin: Unimpaired Flow and Current Flow Conditions by Water Year Type..... | 3-22 |
| 3.3.4-1 | Central Sierra Basin: Unimpaired Flow and Current Flow Conditions by Water Year Type..... | 3-23 |
| 3.4.4-1 | San Joaquin River Basin: Unimpaired Flow and Current Flow Conditions by Water Year Type..... | 3-29 |
| 3.5.4-1 | Total Annual Delta Outflows: Unimpaired Flow and Current Flow Conditions by Water Year Type..... | 3-45 |
| 3.5.4-2 | Estimated Delta Outflow Requirements of the 1978 Delta Plan..... | 3-46 |
| 3.6.2.1-1 | Bathymetric Data for San Francisco Bay..... | 3-53 |
| 3.6.3.2-1 | San Francisco Bay Basin Local Inflow Study - Unimpaired Flow Conditions..... | 3-62 |

Tables (continued)

| | | |
|-----------|--|------|
| 3.6.4.2-1 | San Francisco Bay Area Local Runoff..... | 3-65 |
| 3.6.4.2-2 | San Francisco Bay Local Runoff..... | 3-66 |
| 3.6.4.2-3 | San Francisco Bay Basin: Unimpaired Flow and Current Flow Conditions by Water Year Type..... | 3-64 |
| 4.2-1 | Major Municipal Water Demands..... | 4-2 |
| 4.3-1 | Industrial Water Use Table - 1975..... | 4-4 |
| 4.4.1.3-1 | 1977 to 1984 Crop Acreages and Percentages for the Sacramento-San Joaquin Delta..... | 4-9 |
| 4.4.1.3-2 | Economic Value of Delta Crops and Livestock..... | 4-8 |
| 4.4.1.4-1 | Delta Service Area Crop Salt Sensitivity..... | 4-10 |
| 4.4.2-1 | Crops Produced in Contra Costa Water District, 1986 | 4-11 |
| 4.5.1.2-1 | Chinook Salmon Environmental Requirements and Life History Stages..... | 4-18 |
| 4.5.1.2-2 | Estimated Average Annual Harvest of Chinook Salmon and the Hatchery Contribution to the Catch of Central Valley Salmon..... | 4-27 |
| 4.5.1.2-3 | Estimated Dollar Value of Chinook Salmon Caught in California..... | 4-28 |
| 4.5.1.4-1 | American Shad Environmental Requirements and Life History Stages..... | 4-31 |
| 4.5.1.5-1 | Fishes of the Delta..... | 4-35 |
| 4.5.1.5-2 | Annual Average Water Quality Trends in the Delta. | 4-38 |
| 4.5.2.3-1 | Most Common Bay Fin Fish Collected from Demersal, Pelagic, and Nearshore Areas by DFG, 1980-1986... | 4-49 |
| 4.5.2.3-2 | Life History and Descriptive Information for the Most Abundant Species of Fish Collected..... | 4-51 |
| 4.5.2.3-3 | Relationship Between Freshwater Outflow and Abundance and Distribution of Various Life Stages of the Most Abundant Fish..... | 4-52 |
| 4.9.1-1 | Municipal and Industrial Water Contracts, Central Valley Project..... | 4-62 |
| 4.9.1-2 | SWP Water Deliveries for Agriculture, Municipal and Industrial Uses, Recreation Use at SWP Facilities and Hydroelectrical Energy, 1962 to 1985 | 4-63 |
| 4.9.1-3 | Delta Drinking Water Diversions and Areas Served... | 4-64 |
| 4.9.2-1 | CVP Export Areas..... | 4-66 |
| 4.9.2-2 | Agricultural Water Exports and Service Areas by CVP Unit for the 1985 Water Year..... | 4-67 |
| 4.9.2-3 | Major Crops Grown in the CVP Export Area by Acreage and Gross Cash Value..... | 4-68 |
| 4.9.2-4 | Major Crops Grown in the SWP Export Area by Acreage and Gross Cash Value..... | 4-68 |
| 5.3.1.1-1 | Decision 1485 Water Quality Standards for the Sacramento-San Joaquin Delta and Suisun Marsh.... | 5-3 |
| 5.3.1.3-1 | Unimpaired Flow Mean Salinity..... | 5-6 |
| 5.3.1.3-2 | Optimal Level of Protection for Municipal and Industrial Uses..... | 5-7 |
| 5.3.3.1-1 | Water Quality Standards for Western Delta Agriculture..... | 5-8 |
| 5.3.3.1-2 | Water Quality Standards for Interior Delta Agriculture..... | 5-9 |
| 5.3.3.1-3 | Water Quality Standards for Southern Delta Agriculture..... | 5-10 |

Tables (continued)

| | | |
|-----------|---|-------|
| 5.3.3.4-1 | Optimal Level of Protection for Agricultural Uses | 5-26 |
| 5.3.4.1-1 | 1978 Delta Plan Salmon Standards..... | 5-27 |
| 5.3.4.1-2 | Estimated Survival Index Values Under 1978 Delta Plan Salmon Migration Flow Standards During April-June..... | 5-31 |
| 5.3.4.1-3 | Estimated Controlling Delta Outflows Under the 1978 Delta Plan During Fall Run Smolt Migration Period..... | 5-32 |
| 5.3.4.1-4 | Comparison of Mean Monthly Controlling Delta Outflows and Actual Delta Outflows in cfs (From DWR DAYFLOW)..... | 5-33 |
| 5.3.4.2-1 | Recommended Salmon Flow Standards with Present Delta Plan Delta Outflows for Striped Bass (SWC, USBR, DWR)..... | 5-35 |
| 5.3.4.2-2 | Recommended Objectives for Chinook Salmon (USFWS, DFG, NMFS)..... | 5-37 |
| 5.3.4.2-3 | Recommended April-June Salmon Smolt Migration Standards (EDF)..... | 5-39 |
| 5.3.4.2-4 | Recommended Salmon Smolt Protection Levels (BISF) | 5-40 |
| 5.3.4.3-1 | Estimated Weighted Survival Indices Under Delta Plan Conditions..... | 5-47 |
| 5.3.4.3-2 | Comparison of April-June Rio Vista Flows for Selected Historical Periods and Corresponding Smolt Survival Indices..... | 5-49 |
| 5.3.4.3-3 | Survival of Marked SMolts Released at Different Locations in the Delta..... | 5-58 |
| 5.3.4.3-4 | Comparison of Mean Annual Estimated Chinook Salmon Losses and Monthly Exports at the CVP and SWP Fish Protection Facilities, 1957-1986 and Mean Annual Exports in cfs..... | 5-64 |
| 5.3.4.3-5 | Optimal Levels of Protection for Salmon..... | 5-69 |
| 5.3.5.1-1 | Methods to Assess Population Levels of Striped Bass..... | 5-71 |
| 5.3.5.1-2 | Striped Bass Index Data..... | 5-74 |
| 5.3.5.3-1 | Optimal Levels of Protection for Striped Bass.... | 5-82 |
| 5.3.6.3-1 | Optimal Level of Protection for American Shad.... | 5-92 |
| 5.3.6.3-2 | San Joaquin River - Percent of Total Delta Inflow (Unimpaired Flow Conditions; 1922-1978)..... | 5-95 |
| 5.3.6.3-3 | Flow Required at Vernalis (in cfs) to Meet Recommended Percent of 20,000 cfs Total Delta Inflow | 5-95 |
| 5.3.6.3-4 | Estimated Unimpaired Flow at Vernalis (in cfs) and Probability of Meeting Recommended Flow Under Unimpaired Conditions..... | 5-95 |
| 5.3.7.3-1 | Optimal Level of Protection for Wildlife (including Threatened and Endangered) Use in Suisun Marsh Tidal Channel Wetlands..... | 5-101 |
| 5.3.7.3-2 | Optimal Level of Protection for Wildlife (including Threatened and Endangered) Use in Suisun Bay Tidal Channel Wetlands Outside Suisun Marsh..... | 5-102 |

Tables (continued)

| | | |
|-----------|--|---------------|
| 5.3.7.3-3 | Optimal Objectives for Salinity of Water in Suisun Marsh Tidal Channels to Maintain Sensitive Plant Species..... | 5-103 |
| 5.3.8.3-1 | Optimal Level of Protection for Navigation Use... | 5-107 |
| 5.4.1 | Optimal Water Quality Objectives for Municipal and Industrial, Agricultural, Wildlife, Salmon and Delta Fishery Uses..... | 5-109, 110 |
| 6.2.1-1 | Reasonable Consumptive Agricultural Needs..... | 6-4 |
| 6.2.2-1 | Reasonable Consumptive Municipal and Industrial Needs..... | 6-7 |
| 6.2.3-1 | Supply and Demand for Southern California Areas Which Receive State Water Project Waters..... | 6-12 |
| 7.2.3.1-1 | Alternative Levels of Protection for Sacramento and San Joaquin Salmon Outmigration..... | 7-8 |
| 7.2.3.2-1 | Alternative Levels of Protection for Delta Fisheries (Including Stiped Bass) Via Delta Outflow..... | 7-13 |
| 7.2.3.2-2 | Alternative Levels of Protection for Delta Fisheries (Including Striped Bass) Via Export Limits..... | 7-15 |
| 7.3.1 | Alternative Sets of Water Quality Objectives..... | 7-21 |
| 7.3.2-1 | April-July Water Supply Impacts of Alternative Sets of Water Quality Objectives - 1990 LOD Operations Study..... | 7-29 |
| 7.3.2-2 | April-July Water Supply Impacts of Alternative Sets of Water Quality Objectives - 1972-1987 (W/O 1983) Historical Hydrology..... | 7-30 |

APPENDIX

- A - Past Proceedings Related to Flow and Salinity Objectives for the Bay-Delta Estuary
- B - DAYFLOW and Salmon Survival Data Sets
- C - Terms, Symbols and Abbreviations
- D - Map of Water Quality Control Stations

1.0 EXECUTIVE SUMMARY

1.1 Background

The San Francisco Bay and Sacramento-San Joaquin Delta Estuary (Bay-Delta Estuary) includes the Sacramento-San Joaquin Delta (Delta), Suisun Marsh and San Francisco Bay. The Delta is composed of about 738,000 acres, of which 48,000 acres are water surface area; Suisun Marsh comprises approximately 85,000 acres of marshland and waterways. San Francisco Bay includes around 300,000 acres of water surface area. The Delta and Suisun Marsh are located where California's two major river systems, the Sacramento and San Joaquin rivers, converge to flow westward where they meet seawater in the San Francisco Bay. The Bay-Delta Estuary is one of the largest, most important estuarine systems for fish and waterfowl production in the United States. The Delta is also one of the state's most fertile and important agricultural regions and is the location of a major industrial corridor in the vicinity of Antioch.

The watershed of the Bay-Delta Estuary provides about two-thirds of all the water used in California, including 40 percent of the state's drinking water. Two major water distribution systems export supplies from the Delta to areas of use: the State Water Project (SWP) operated by the California Department of Water Resources (DWR), and the Central Valley Project (CVP) operated by the U.S. Bureau of Reclamation (USBR). Numerous other water development projects also alter the river inflows into the Bay-Delta Estuary.

Salinity and flow objectives protect the beneficial uses of water in the Delta and Suisun Marsh. Existing objectives affect operations of the SWP and the CVP. New flow and salinity objectives for the entire Bay-Delta Estuary affecting the SWP, the CVP and other water diverters in the Bay-Delta watershed are being considered by the State Water Resources Control Board (State Board).

1.2 Hearing Process

In 1987 the State Board began a three-phase hearing process to receive and examine evidence on beneficial uses and water quality issues for the possible revision of existing water quality objectives in the Bay-Delta Estuary. The Water Quality Control Plan for Salinity for the San Francisco Bay and Sacramento-San Joaquin Delta Estuary (Plan), one of two documents prepared after the first hearing phase, addresses salinity levels and flow regimes necessary to protect the beneficial uses of Bay-Delta water. The second document, a Pollutant Policy Document (PPD), addresses other pollutants affecting beneficial uses of Bay-Delta water. This latter document will give guidance to the two Regional Water Quality Control Boards which have regulatory responsibility within the Bay-Delta Estuary. Both documents are being circulated for public review. Public comments from that review will be received during Phase II of the hearing process currently scheduled to begin in January 1989. Once these documents have been evaluated and revised by the State Board, they will be adopted. During Phase III, the State Board will conduct a water right hearing to consider implementation of the Plan by the appropriate water right holders.

1.3 Purpose and Current Context of the Plan

The draft Plan has been prepared by State Board staff after careful review and evaluation of the evidence presented during Phase I of the hearing. The Plan includes a description of a series of alternatives and recommendations for the flow and salinity levels needed to protect beneficial uses in the Bay-Delta Estuary; it is prepared under the authority of Water Code Section 13170.

1.4 Structure of the Plan

The draft Plan reflects the process by which the competing beneficial uses of Bay-Delta waters are balanced to provide reasonable protection for each beneficial use.

1.4.1 Chapter 1 -- Executive Summary

The Executive Summary serves as the first chapter of the Plan.

1.4.2 Chapter 2 -- Scope of the Plan

The Plan contains recommended flow and salinity objectives, as well as a program of implementation which will provide reasonable protection for beneficial uses of Bay-Delta Estuary water. In determining these levels of protection, all uses of water originating from and transferred into the Bay and Delta hydrologic basins are considered. The flow and salinity objectives for the Bay-Delta Estuary contained in this Plan supercede any conflicting objectives contained in the current Water Quality Control Plans of the San Francisco Bay and Central Valley Regional Water Quality Control Boards and other State Board plans.

- Board Authority

water rights

The State Board is responsible for formulating and adopting state policy for water quality control. Under its water right authorities, the State Board can condition rights for the diversion and use of water. The Board has continuing authority over all water rights to prevent waste and unreasonable use of water and to protect public trust uses. The Board also has authority under the Water Code to impose specific terms and conditions on new permits to protect the public interest, prior water rights, recreation, fish and wildlife, and other interests.

water quality

Recent court decisions, specifically, the Racannelli or Delta Water Cases Decision,^{1/} have directed the State Board to take a global perspective of water resources in developing water quality objectives. The State Board's duty in its water quality role is to provide reasonable protection for beneficial uses, considering all demands made on the water.

^{1/} United States v. State Water Resources Control Board (1986)
182 Cal.App.3d 82, 227 Cal.Rptr 161.

The State Board's water quality function is related to but not coincident with protection of water rights. Water quality objectives are not to be limited to what the State Board can enforce under its water right authority. The court recognized, however, that an implementing program may be a lengthy and complex process that requires significant time intervals and action by entities over which the State Board has little or no control.

The contents of each Chapter are briefly described in Chapter 2 along with the geographic limits for the water quality objectives set in the Plan. The PPD is also identified as establishing state policy for pollutant regulation in the waters of the Bay-Delta Estuary.

1.4.3 Chapter 3 -- Basin Description

The Bay-Delta Estuary and its adjacent areas described in the Plan include the Delta; the Delta's tributary areas of the Sacramento River, the Central Sierra and the San Joaquin River basins; and the San Francisco Bay and its hydrologic basin. This chapter provides information on the physical description, hydrology, and unimpaired and current flow conditions for each of these areas.

- Water Year Classification

Under the Delta Plan adopted in 1978, water quality objectives were set for different water year classifications. Those classifications were wet, above normal, below normal, dry, and critically dry and were based on the four rivers of the Sacramento Basin. In this Plan the classification is still used (see Figure 1), but in addition, a separate water year classification has been established for the San Joaquin River Basin. The San Joaquin River Basin classification (see Figure 2) is based on the following four tributaries: the Stanislaus, Tuolumne, Merced, and San Joaquin rivers. An 82-year period, 1906 through 1987, is used to determine the classification boundaries for both river basins, instead of the 50-year period, 1922 through 1971, used in the 1978 Delta Plan. The current water year and the "year following critical year" designations are based on the April through July runoff, and apply to all objectives, not just those for fish and wildlife.

The San Joaquin River Basin water year classification is used for water quality objectives in the southern Delta and for the export objectives.

1.4.4 Chapter 4 -- Beneficial Uses

A clear understanding of each beneficial use builds a foundation for weighing and balancing appropriate levels of protection discussed in succeeding chapters. Beneficial uses include domestic, municipal, agricultural and industrial supply; recreation; esthetic enjoyment; navigation; and preservation and enhancement of fish, wildlife, and other aquatic resources. In summarizing issues addressed during Phase I of the Bay-Delta hearing, this chapter discusses what beneficial uses are, their flow requirements and their salt tolerances.

1.4.5 Chapter 5 -- Optimal Levels of Protection

The levels of flow and salinity considered to be optimal for the protection of each beneficial use without regard to others are presented in this chapter. Three alternatives for each beneficial use are discussed: (1) the no action alternative; (2) advocated levels of protection; and (3) the optimal level of protection.

1. The no action alternative is the existing level of flow and salinity protection for the beneficial use being discussed. This level complies with federal regulations protecting existing uses.
2. Advocated levels of protection are those recommended by the participants in Phase I of the hearing. Testimony or exhibits that recommend flow and salinity levels to protect a specific beneficial use are summarized.
3. The optimal level can be the same as one or both of the previous two if they provide optimal protection; it can also be a separate level based upon an independent evaluation of available data. In any case, the optimal level provides the ideal condition for a specific beneficial use and the background against which all alternatives developed in Chapter 7 can be measured.

1.4.6 Chapter 6 -- Reasonable Demands for Consumptive Use of Bay-Delta Waters

This chapter offers a California water ethic (discussed subsequently) along with assumptions on water use that are consistent with this ethic. In order to preserve and distribute California's limited water resources equitably, there is a distinct need for a high degree of conservation, reclamation and conjunctive use of water.

Since some beneficial uses have competing needs, an examination of optimal levels shows that full protection of all beneficial uses in all water years is impossible. There simply is not enough water. Also, protection of some uses can conflict with the needs of others. Some accommodation has to occur. An analysis of the reasonable consumptive needs for Bay-Delta water in areas upstream, within, and exported from the Estuary reveals that water can be managed differently to meet existing and reasonable future needs.

water ethic

simply not enough water for all B-uses

Water users offered projections of water needs to the year 2010. In these projections, some water savings were assumed. However, a more rigorous application of the California water ethic indicates that greater savings can be realized. Further, this chapter evaluates the ability to increase April through July Sacramento and San Joaquin river flows through the conjunctive use of surface and ground water and the changing of reservoir operations. The objectives in Chapter 7 are founded on the foregoing assumptions.

Estimates of agricultural water conservation savings are based on a more efficient, yet achievable, water application and reuse program. }

The assumed water saving methods apply to all municipal and industrial needs, including upstream areas tributary to the Estuary, in-basin areas, downstream areas, and export areas. Estimates of savings are based on an aggressive water conservation and reclamation program.

1.4.7 Chapter 7 -- The Development of Reasonable Alternative Water Quality Control Objectives

Reasonable water quality and instream flow needs for beneficial uses in the Estuary are discussed. These water quantity and water quality needs are compared in six sets of alternatives; the water supply impacts are summarized for three components: Sacramento and San Joaquin river inflows and Delta exports. To achieve equitable global balancing of protection for beneficial uses, the reasonable water quality and flow needs of the Estuary are weighed against the appropriateness of achieving those flows. Alternative five (5) is recommended (see Recommendation Section below).

*Racemelli
savings*

*equitable
global
balancing*

1.4.8 Program of Implementation

Programs that reflect the need for the long range California water ethic are highlighted. They include water conservation and reclamation. The Plan anticipates that water projects other than the CVP and SWP will be modified as needed to protect beneficial uses in the Estuary. Additional water facilities such as ground water and offstream storage facilities are encouraged. The Central Valley Regional Water Quality Control Board is requested to adopt a salt load reduction policy. Various monitoring programs and legislative proposals are also suggested.

1.5 Concerns

During Phase I of the hearing, evidence was introduced about the need for adequate protection of water quality for agricultural, municipal, industrial and biological uses in the Estuary. The data show a prolonged decline in the natural salmon population and Delta fish as they related to water project operations (see Figure 3). The need for water to reduce salinity levels and for sufficient flows to protect the resources in the Estuary was presented. Considering the certainty of California's population and economic growth, representatives from several areas of the state testified that large amounts of additional water would be needed in the future.

Several witnesses testified about the availability of water. The evidence shows a greater need for water than the available supply. A broad balancing of that evidence has been made in recommending flow and salinity objectives.

In the balancing process, it should be recognized that biological resources have declined and are not experiencing the same degree of protection as other beneficial uses. Past balancing to protect biological resources has not been as effective as projected according to present evidence. This decline has been taken into consideration in the balancing process.

1.6 California Water Ethic

All Californians must practice conservation, reclamation and conjunctive surface and ground water use in order to share responsibility for the reasonable use of water appropriately.

California's ground and surface waters are a precious, but limited resource. Water rights allow only the reasonable use of this resource. Water is vital to homes, industry, agriculture and public trust values. Supplies vary substantially from year to year. In the past, dams were built to control flooding and provide supplies during prolonged dry periods. Today, additional actions to promote the conservation, control and maximum utilization of water are required (Water Code Section 13000). All Californians must become involved in the reasonable use of water.

The California water ethic includes the coordination of several programs, each applicable in varying degrees to every region of the state. Best management practices related to the use of water are needed in all areas of the state. Careful water use decreases pollutant loadings as well as water demands.

The water ethic assumes:

- Conservation -- Municipal and industrial water users (residential, industrial and commercial) will be metered. With appropriate plumbing, leak detection, and landscaping techniques, per capita water use will be significantly reduced. Also, there are substantial opportunities for water savings by commercial and industrial water users. All agricultural users will use water as efficiently as feasible, particularly those who contribute drainage flows to salt sinks where reuse is impractical.
- Reclamation -- Where feasible, water reclamation and recycling consistent with state laws shall be required to reduce the demand on existing potable water supplies. Water reclamation includes the enhanced treatment of wastewater for reuse, the conversion of saline water to freshwater, and the treatment of ground water to a sufficient level to allow subsequent beneficial use.
- Conjunctive Use -- Ground water storage basins will be effectively utilized in conjunction with distribution of surface water.

- Sharing Responsibility -- Adequate flows for beneficial uses in the Estuary are the responsibility of all water users in the Bay-Delta watershed. In the past this obligation has been imposed largely on the CVP and SWP.
- Physical Facilities -- To better manage California's water resources, physical facilities are encouraged.
- Pollution Control -- Maximum practical pollution control at the source takes precedence over releases of freshwater for flushing flows.

1.7 Principles Guiding the Development of Water Quality Objectives

The following principles will assist in the conservation and equitable distribution of California's limited water resources. These principles are founded upon the foregoing water ethic, a careful review of the Phase I hearing evidence, an understanding of the Board's authority, and the appellate court's direction. Further, these principles also provide reasonable protection to each of the beneficial uses of the waters of the Bay-Delta Estuary under Water Code Section 13241.

- Municipal and industrial water users should receive salinity protection of at least the secondary public health standard of 250 mg/l chloride.
- Delta agricultural users should receive water quality that fully protects their needs assuming that they are employing best management practices and to the extent that such quality was available under unimpaired conditions with present day channel configurations (see Cal. Const., Art X, Sec.2).
- Aquatic life in the Estuary should receive the salinity and flows at an appropriate historic level. The appropriate historic level is established during the balancing process as subsequently explained. (See Water Code Section 1243; Public Resources Code Section 21000, et seq.; State Board Resolution 68-16). } find this
- The formation of trihalomethane compounds from Delta waters cannot reasonably be resolved through the establishment of flow and salinity objectives.
- At this time, the use of Delta outflow solely to flush pollutants, other than ocean derived salts, out of the Estuary is not reasonable. The need for such flows may be considered in the future after all reasonable source control methods have been implemented and only if it is found to be in the public interest. } forces pollution control upstream to users
- Increasing Delta inflows and decreasing Delta exports in the spring (which among other things will reduce reverse flows in the Old and Middle rivers) offers the best chance to obtain balanced protection of all beneficial uses dependent upon Bay-Delta water supplies. The Department of Water Resources should continue to investigate the potential for protecting beneficial uses and more efficient use of water through development of physical facilities.

The foregoing principles were used as assumptions in developing the water quality objectives contained in this Plan.

1.8 Recommendations

The Plan develops new water quality objectives for each beneficial use in the Estuary. The water quality objectives are shown in Table 1 and a summary of these objectives is presented below. Control stations for the objectives are depicted in the accompanying map (See Appendix D).

1. Municipal and industrial intakes are provided water quality protection for the secondary public health standard of 250 mg/l chloride. Actual water quality during most of the year will be considerably better than this due to the "umbrella" protection provided by other objectives.

The 150 mg/l chloride objective at the Rock Slough intake of the Contra Costa Water District is deleted. The beneficial uses of water will be reasonably protected at 250 mg/l chloride. The users from this intake could relocate their intake, construct local reservoirs to capture winter time flows for blending in the summer, and take other actions to improve their water quality consistent with local desires for such quality and local economics.

2. Agricultural users in the Delta are provided water quality that fully protects their needs assuming that they are employing best management practices and to the extent such water quality was available under unimpaired flow with existing channel configurations. Evidence presented during the hearing indicates that the farmers on the Delta's organic soils can achieve full crop yields with saltier water than previously believed. The new objectives reflect these data.

SDWA
Agricultural pursuits on southern Delta mineral soils need better water quality than currently exists. The Plan will improve water quality so that these users are better protected.

3. Aquatic life in the Estuary has suffered losses in the recent past. The best data are for only two fish species--salmon and striped bass. Abundance of those species is affected by inflows into and exports from the Estuary, especially during the April through July period. The objectives for the Sacramento River salmon populations are established to attain the 1930-87 average monthly April through June flows (for each year type) which have been shown to be important to salmon. This represents all the data available for interior Delta stations important for salmon protection. The level of protection prescribed for the Sacramento River system was found to be unattainable on the San Joaquin River system without an unreasonable impact on upstream consumptive uses. An achievable and reasonable level of protection was the attainment of average flows that have existed since the current physical configuration of the Delta (1953-87). Also, minimum flows to protect striped bass

*after
completion of
DCA &
CVP*

recommended by the State Department of Fish and Game (DFG) and supported by the U. S. Fish and Wildlife Service are incorporated in the recommended objectives. Export limits during the April through July period are made equivalent to the levels that existed before the decline of young fish survival in the Delta (1953-1967), but only to the extent that such reductions are needed to reduce the magnitude of reverse flows in Old and Middle rivers.

These levels reflect the average monthly exports that occurred during April through July for each year type in the period 1953-1967. One may note under Delta Fishery Export Limits in Table 1 that export limits for dry and critical years exceed those allowed in more water plentiful year types. The resilience of the fishery resource demonstrated in the past illustrates that the resource can withstand greater impacts of the magnitude shown for a short period of time (dry and critical years) and still recover.

These new objectives better protect aquatic resources than the previous objectives.

4. Suisun Marsh is provided protection generally consistent with the Four-Agency Agreement signed by the Suisun Resource Conservation District, DFG, State Department of Water Resources, and the U. S. Bureau of Reclamation. The only difference is that in water deficient years, year types are determined by using the median year runoff forecasts instead of the lower 20 percent forecasts as used in the agreement. This provides better protection than the Four-Agency Agreement. The Board is requesting DFG's advice during Phase II on the effects of the agreement on endangered species within tidal marshes in the Suisun Bay area.
5. San Francisco Bay was discussed extensively during the Board's Phase I hearing. Information presented showed an insufficient connection between physical changes in the Bay due to inflows and the beneficial uses in the Bay. The evidence presented was judged insufficient as a basis for water quality objectives. The Board will require that further studies be performed to address these concerns and that such concerns will be addressed in the consideration of the water right permits of any large unconstructed water storage projects.

SF Bay connection appeared tenuous
6. Analyses of the reasonable consumptive water needs of areas receiving exported water from the Delta indicates that the needs through the year 2010 can be met without increasing current annual exports. This assumes the California water ethic set forth previously is implemented. In Phase III the Board should consider the following in order to best conserve and utilize Bay-Delta waters:
 - a. The combined export quantity per water year from the USBR Tracy Pumping Plant and the SWP Banks Pumping Plant be limited, except that in wet and above normal years water above that required to meet objectives in the Bay-Delta Estuary may be pumped for conjunctive ground water storage and offstream surface storage; and

skimming of floods OK

- b. The amount of water pumped per water year at the SWP Edmonston Pumping Plant for use in the southern California portion of the SWP service area be limited, except that: (1) an increase above that amount equal to the quantity of water conserved through increased agricultural efficiency in the San Joaquin Valley would be allowed; and (2) in wet and above normal years water above that required to meet objectives in the Bay-Delta Estuary may be pumped for conjunctive ground water storage and offstream surface storage; and
- c. Agricultural users who contribute drainage flows to salt sinks should achieve a high but reasonably attainable water use efficiency.

1.9 Implementation

Many of the recommendations contained in this water quality control plan will be attained through the Board's water right authority. During Phase III of the Bay-Delta hearing process, the Board will determine which water users will share in the responsibility of attaining the water quality objectives specified in the Plan and in achieving other provisions of the Plan. Implementation of all objectives is scheduled to occur over the next six years. A detailed time frame for implementing this Plan will be determined after the specific water users have been identified.

1.10 Water Supply Impacts

Alternative 5 best achieves the balanced levels of protection of beneficial uses described in the foregoing section. The impacts are depicted in Figures 4 and 5.

comparative bases

Two bases of comparison were used to develop an impact analysis. Impacts that could result from the objectives specified in the recommended alternative were compared to: (1) those of the 1978 Delta Water Quality Control Plan (currently in place) using a 1922-78 hydrologic cycle and a projected 1990 level of development as presented by DWR (Figure 4); and (2) actual values using the recent hydrologic period of 1972-87 (Figure 5). Two different analyses of impacts were performed to provide the public with an assessment of the effects of Alternative 5 objectives on planned water diversions in the near future and on historical conditions experienced in the recent past. Note that in the latter analysis, the 1983 water year data were disregarded because that year was the wettest year of record and tended to skew the average.

1983 disregarded

In both instances, the average impacts were analyzed on an annual basis and during the April through July period. The period April through July is particularly significant. Although the top bar graph in both figures depicts average impacts over the period of record, impacts for each year type (i.e., wet, above normal, etc.) were assessed to determine if the objectives were attainable and reasonable. A more detailed analysis of impacts is sought during the Phase II hearings.

1. The top bar graph of both figures reveals that there will be no change in average annual flows nor in the 1985-level of exports. Exports in 1985 are the highest to date, and 16 percent higher than the average amount of water exported since D-1485 standards went into effect in 1978. While Delta inflows from the Sacramento and San Joaquin rivers to meet the recommended Plan objectives increase over those required to meet the 1978 Plan objectives and increase over recent historic levels, annual flows do not. However, as shown in the bottom bar graphs, April through July flows do change. Our analysis shows that the reduction in flows during that period can be fully offset during other months of the year. This assumes partial utilization of existing water reserves on the Sacramento River system, conjunctive use of ground and surface waters in the San Joaquin River Basin, greater utilization of offstream storage south of the Delta, and a rescheduling of exports from the spring to winter months.
2. With regard to Figure 4, total Delta outflow in April through July to protect the Estuary will result in an increase over the long-term hydrologic period of 1922-78 of about 1,560 thousand acre-feet (TAF). If compared to recent historic information (Figure 5), the increase amounts to 1,080 TAF. The increase in April through July Delta outflow is achieved through an increase in river inflows into the Delta (Sacramento River -- 360 TAF and San Joaquin River -- 530 TAF; total of 890 TAF) and a decrease in water exported from the Delta (670 TAF). Correspondingly, Figure 5 illustrates that a total increase in river inflow of 880 TAF is needed with a decrease in exports, on the average, of 200 TAF.

As stated previously, in order to meet the objectives of the recommended alternative and the additional water required, two major actions will be needed. First, a portion of the water reserves in the Sacramento and San Joaquin basins will be required for Estuary protection. According to DWR Bulletin 160-87, the Sacramento Basin currently has a 588 TAF reserve and the San Joaquin has a 157 TAF reserve. These reserves are projected to decrease to 549 and 128 TAF respectively by the year 2010. Second, conjunctive use of surface water and ground water supplies plus a different mode of operation of reservoirs may be needed to make up for water not available in the April through July period. On the San Joaquin River system, for instance, an analysis indicates that such programs could increase flows in the river during the April through July period from at least 170 TAF in critical years to almost 700 TAF in wet years. This change in operations would affect less than five percent of the combined ground water/surface water storage in the Basin.

3. April through July exports from the Delta, projected from the 1990 operations study would be reduced by about 670 TAF under the recommended alternative Plan. A slightly greater reduction (about 680 TAF) would occur if the recommended Plan is compared to the recent high export values of 1985. On the other hand, if comparing to recent historic data, the reduction in exports would amount to 200 TAF on the average, or 540 TAF if compared to the 1985 level of exports. In either case, as demonstrated in the operations study, the capability to recover this deficit exists in the other seasons of the year, albeit a change in export operations would be required.

**FIGURE 1
SACRAMENTO RIVER BASIN
APRIL THROUGH JULY HYDROLOGIC CLASSIFICATION**

The Sacramento River Basin April through July hydrologic classification shall be determined by the forecast of Sacramento Valley unimpaired runoff for the year's April through July period as published in California Department of Water Resources Bulletin 120 for the sum of the following locations: Sacramento River above Bend Bridge, near Red Bluff; Feather River, total inflow to Oroville Reservoir; Yuba River at Smartville; American River, total inflow to Folsom Reservoir. Preliminary determinations of the classification shall be based on the April through July hydrologic conditions to date plus forecasts of future runoff assuming normal precipitation for the remainder of the April through July period.

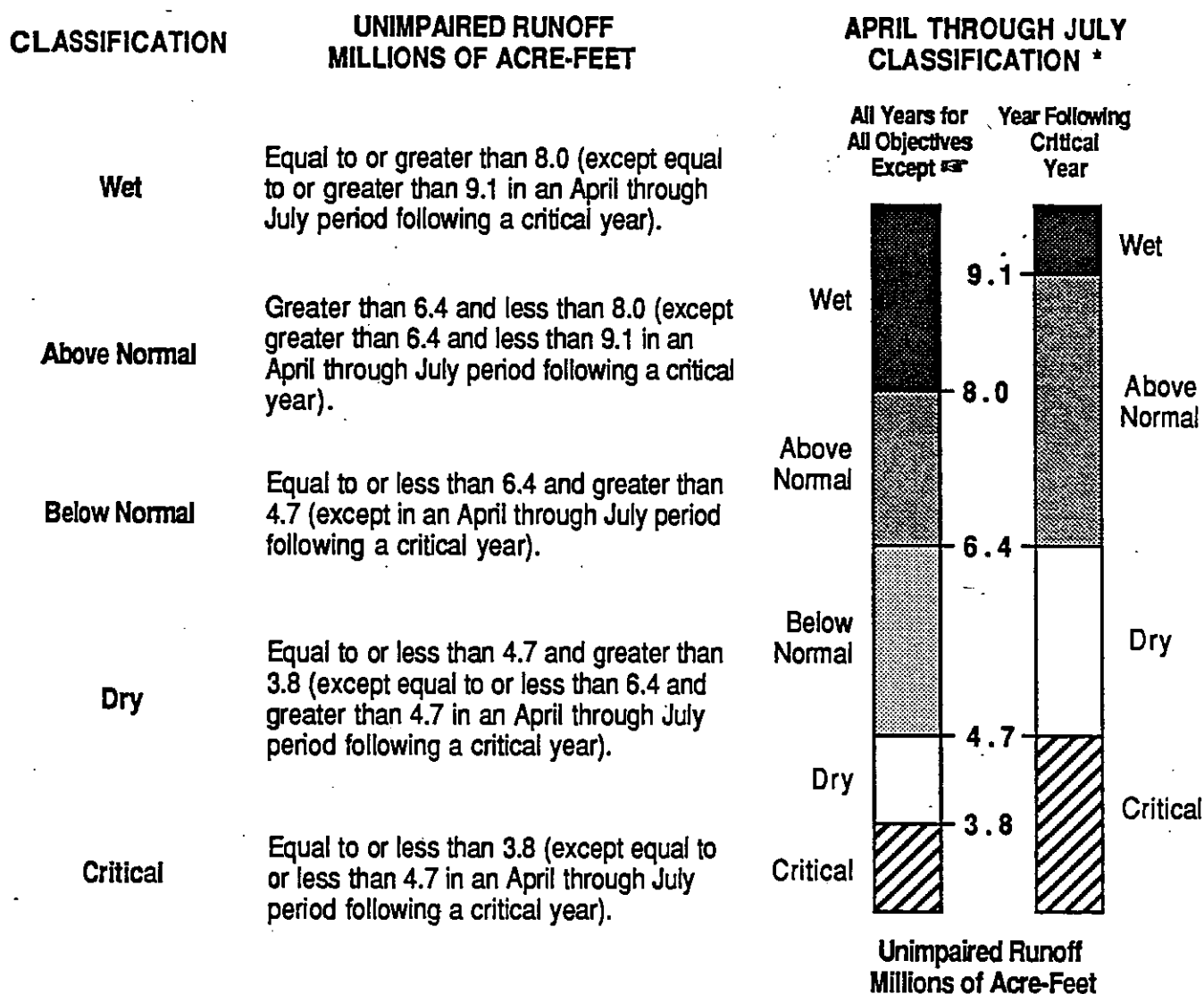

* The April through July classification for the preceding water year will remain in effect until the initial forecast of unimpaired runoff for the current water year's April through July classification is available.

**FIGURE 2
SAN JOAQUIN RIVER BASIN
APRIL THROUGH JULY HYDROLOGIC CLASSIFICATION**

The San Joaquin River Basin April through July hydrologic classification shall be determined by the forecast of San Joaquin Valley unimpaired runoff for the year's April through July period as published in California Department of Water Resources Bulletin 120 for the sum of the following locations: Stanislaus River, total inflow to New Melones Reservoir; Tuolumne River, total inflow to Don Pedro Reservoir; Merced River, total inflow to Exchequer Reservoir; San Joaquin River, total inflow to Millerton Lake. Preliminary determinations of the classification shall be based on the April through July hydrologic conditions to date plus forecasts of future runoff assuming normal precipitation for the remainder of the April through July period.

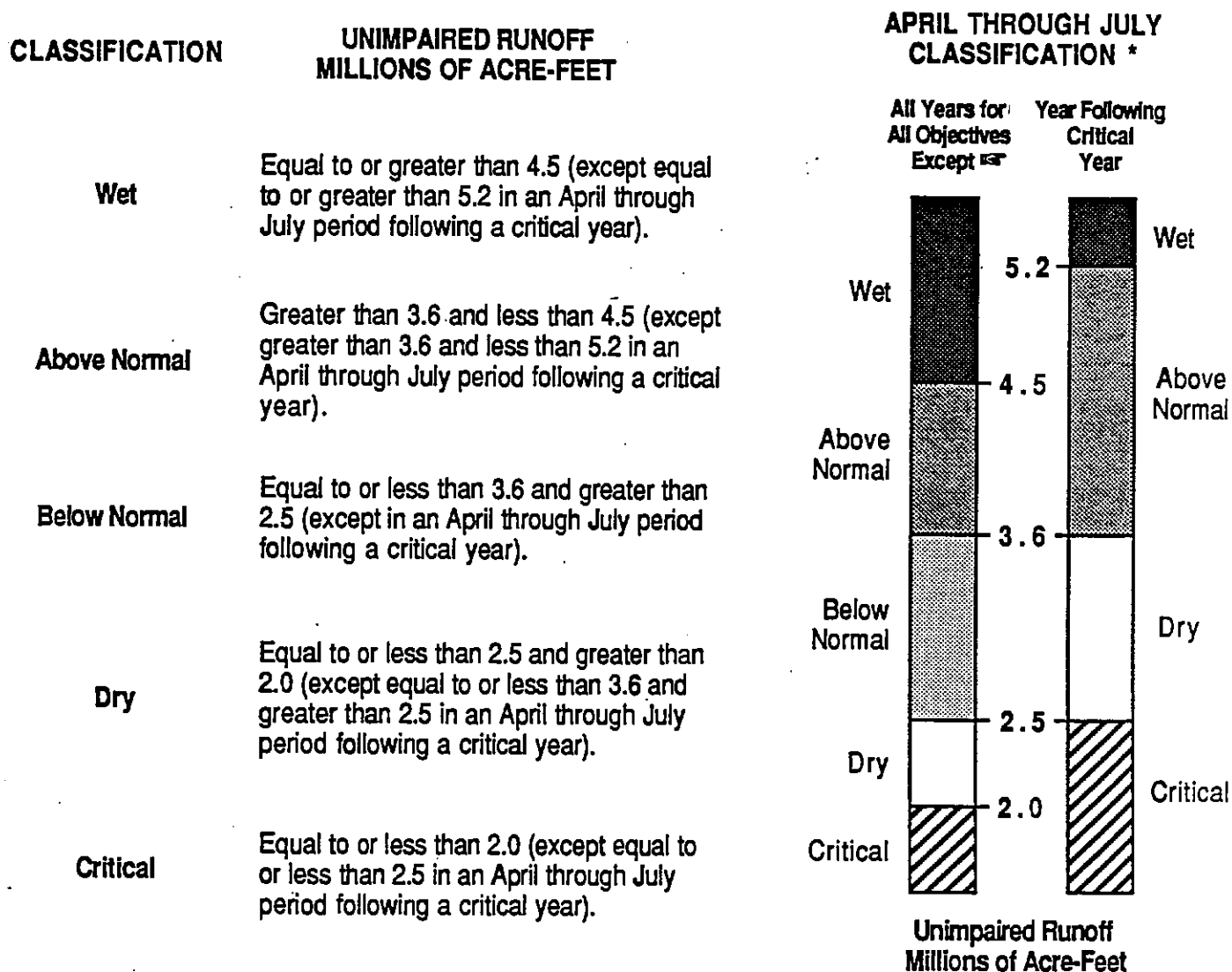

* The April through July classification for the preceding water year will remain in effect until the initial forecast of unimpaired runoff for the current water year's April through July classification is available.

FIGURE 3

STRIPED BASS INDEX, SACRAMENTO/SAN JOAQUIN NATURAL SALMON POPULATION AND TOTAL DELTA EXPORTS

SBI: 1959 - 1988, EXCEPT 1966; POPULATION: SR 1953 - 1984, SJR 1953 - 1984; EXPORTS: AVERAGE APRIL - JULY EXPORTS, 1953 - 1987
(5 Year Running Average)

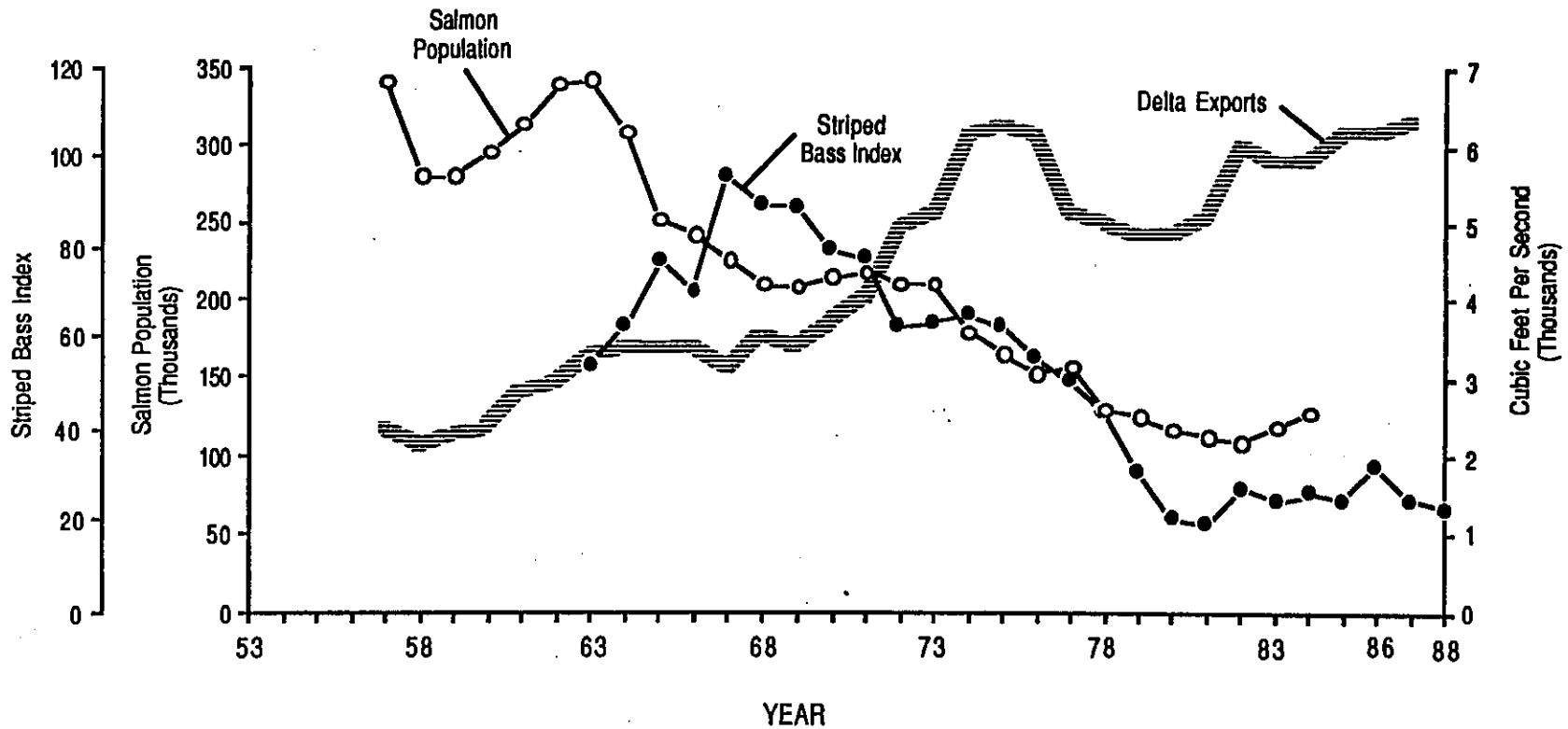

1-14

FIGURE 4 RECOMMENDED PLAN WATER SUPPLY IMPACTS 1922-78 HYDROLOGY UNDER THE PRESENT LEVEL-OF-DEVELOPMENT AVERAGE ANNUAL

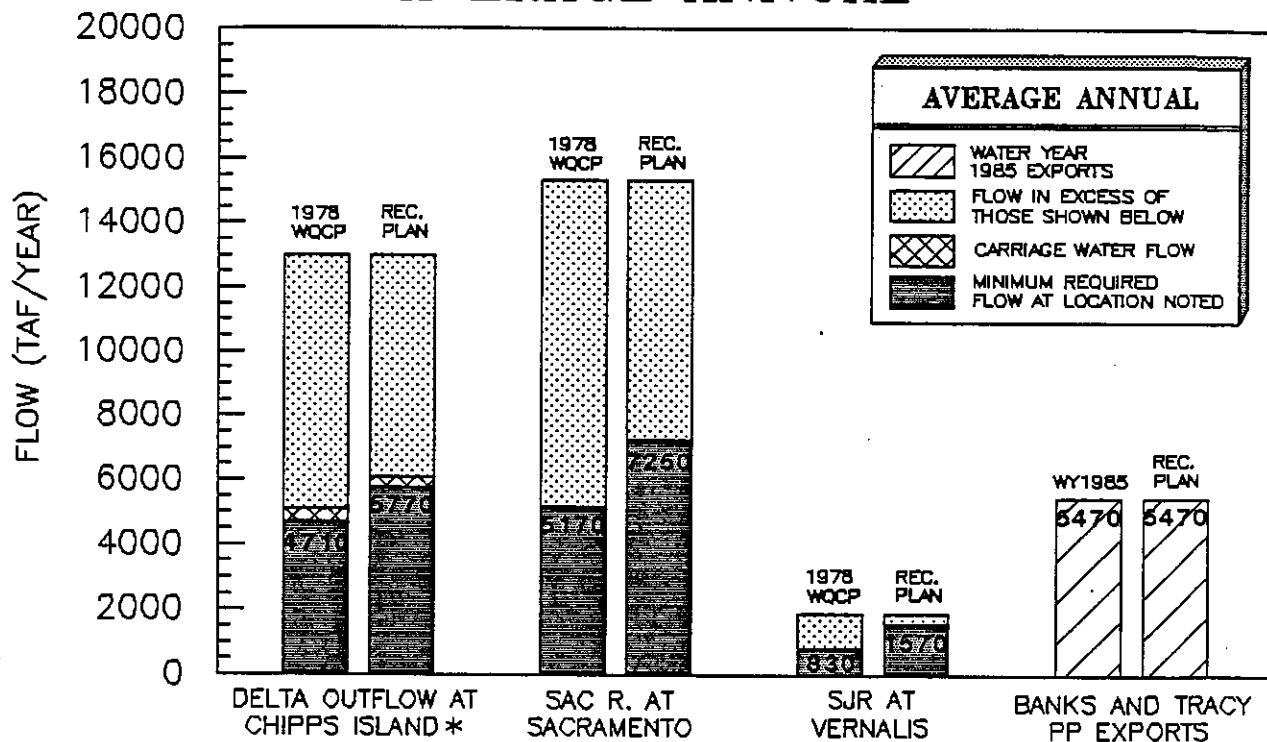

APRIL-JULY

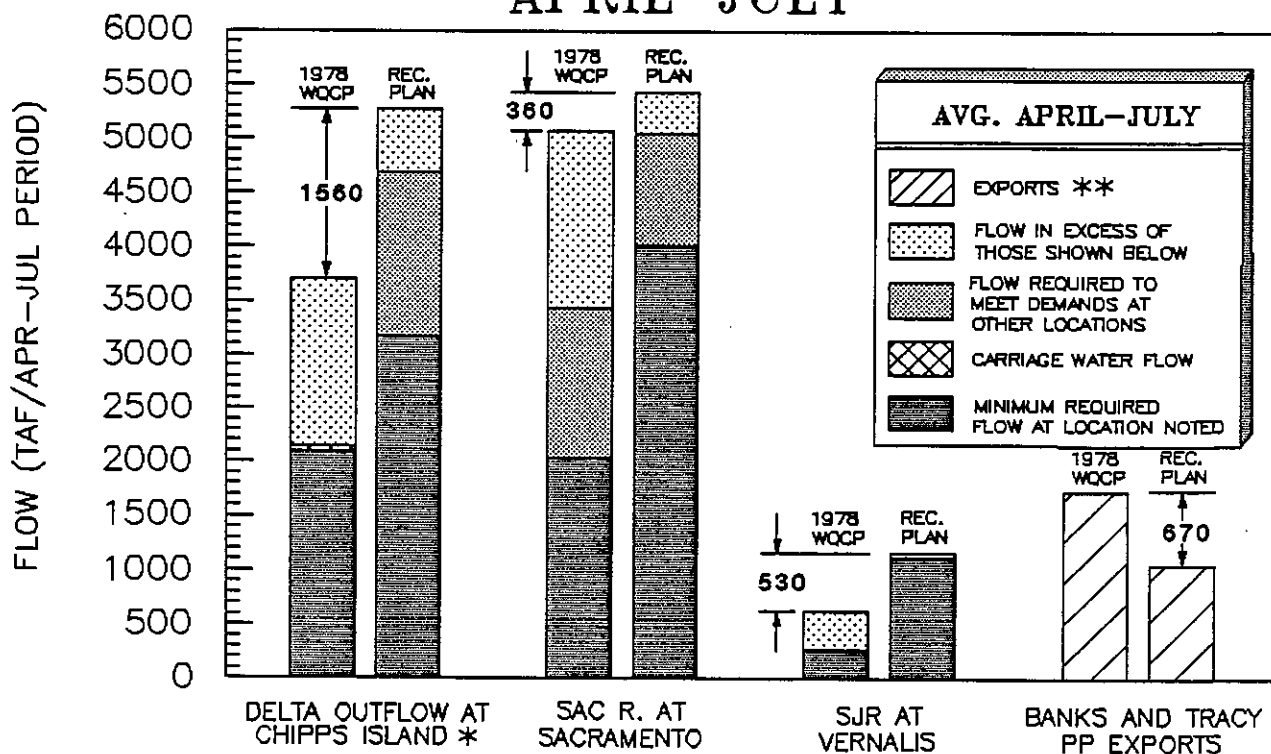

* INCLUDES YOLO BYPASS FLOW

** 1985 EXPORT IMPACT = 680 TAF

FIGURE 5 RECOMMENDED PLAN WATER SUPPLY IMPACTS 1972-1987 (W/O 1983) HISTORIC HYDROLOGY AVERAGE ANNUAL

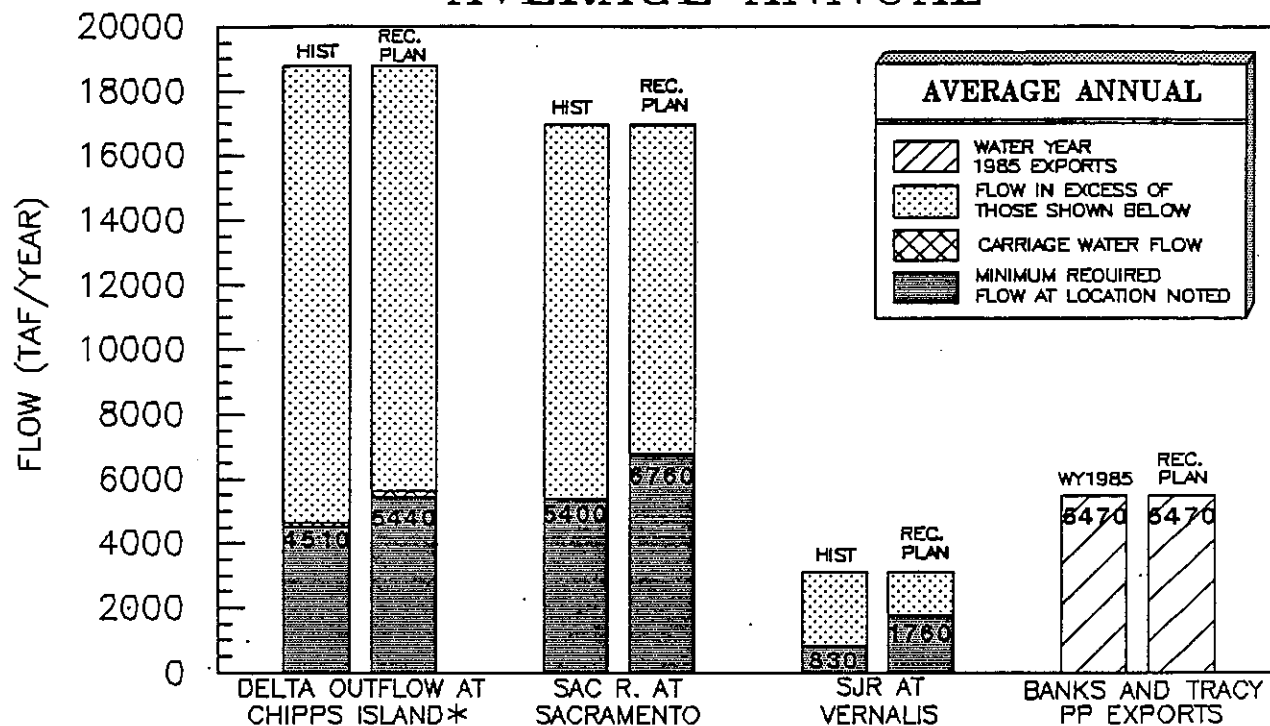

APRIL-JULY

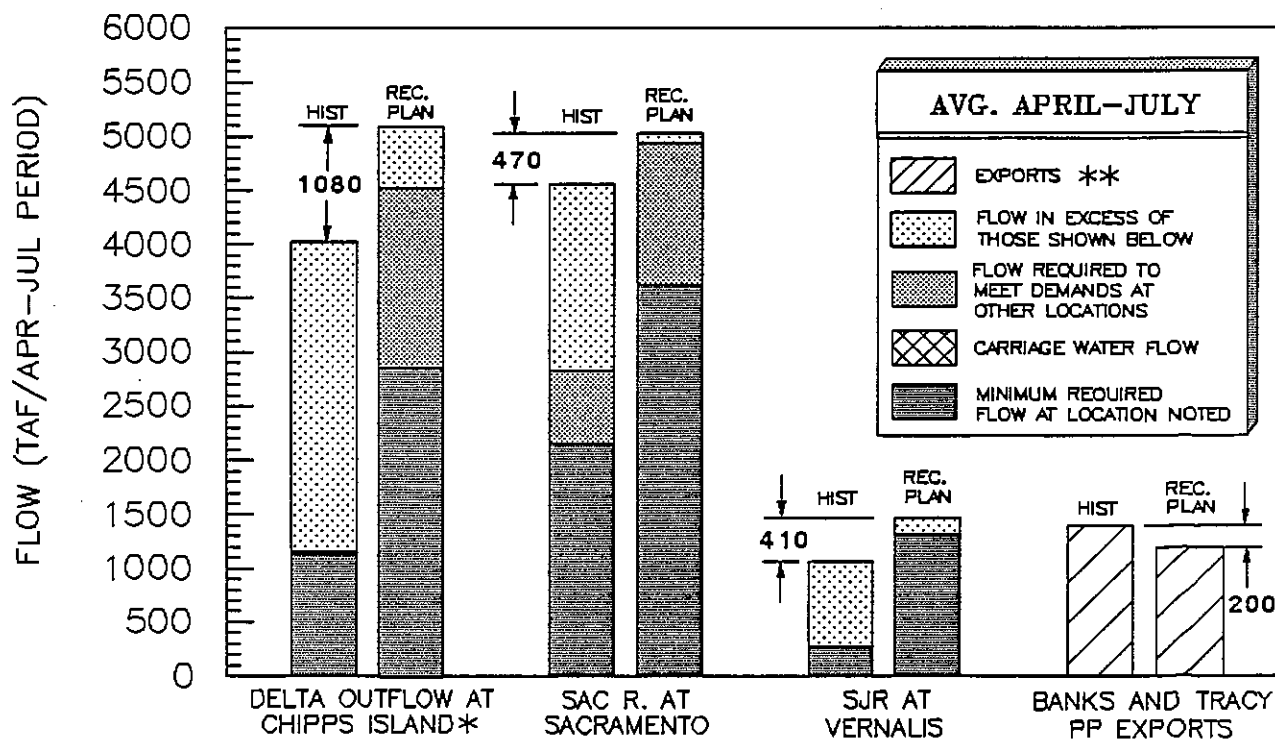

* INCLUDES YOLO BYPASS FLOW

** 1985 EXPORT IMPACT = 540 TAF

TABLE 1
RECOMMENDED WATER QUALITY OBJECTIVES

| Beneficial Use Protected and Location | | Sampling Site # | Parameter | Description | Year Type (Sacramento, unless * shows San Joaquin) | Dates | Values or Limits |
|---|---|------------------|-------------------------|---|--|----------------|----------------------|
| MUNICIPAL and INDUSTRIAL | | | | | | | Cl- |
| City of Vallejo Intake (Footnote 1) | | C19 (Footnote 2) | Chloride | Maximum Mean Daily Chloride, mg/l | All | | 250 |
| Contra Costa Canal at Pumping Plant #1 (Footnote 3) | | C5 | " | " | " | | " |
| Clifton Court Forebay Intake at West Canal | | C9 | " | " | All* | | " |
| Delta Mendota Canal at Tracy Pumping Plant | | DMC1 | " | " | All* | | " |
| North Bay Aqueduct at Barker Slough | | NBA1 | " | " | All | | " |
| AGRICULTURE | | | | | | | |
| Western Delta Irrigation | Emmaton Jersey Pt. | D22 | Electrical Conductivity | Maximum 14-Day Running Average of Mean Daily EC, mmho/cm | All except Critical | Dates 4/1-8/15 | EC 1.5 |
| | | D15 | | | | Critical | 4/1-7/31 8/1-8/15 |
| Interior Delta Irrigation | Cache Slough at Junction Pt. San Andreas Landing Terminous | CS1 | Electrical Conductivity | Maximum 14-Day Running Average of Mean Daily EC, mmho/cm | All | 4/1-8/15 | 1.5 |
| | | C4 | | | | | |
| | | C13 | | | | | |
| South Delta Irrigation | Vernalis Brandt Bridge Tracy Road Br. Mossdale Howard Road Br. at Middle R. Old R. at Middle R. | C10 | Electrical Conductivity | Maximum 14-Day Running Average of Mean Daily EC, mmho/cm | All* | 4/1-8/31 | 0.7 |
| | | C6 | | | | | |
| | | P12 | | | | | |
| | | C7 | | | | | |
| Delta Salinity Leaching | Emmaton Jersey Pt. Cache Slough San Andreas Landing Terminous | D22 | Electrical Conductivity | Winter pond leaching Maximum Monthly Ave. of Mean Daily EC, mmho/cm | All | 12/1-2/28 | 1.7 |
| | | D15 | | | | | |
| | | CS1 | | | | | |
| | | C4 | | | | | |
| | | C13 | | | | | |

See last page of table for Footnotes

1-17

TABLE 1 cont'd

RECOMMENDED WATER QUALITY OBJECTIVES

| Beneficial Use Protected and Location | Sampling Site # | Parameter | Description | Year Type (Sacramento, unless * shows San Joaquin) | Dates | Values or Limits | | | | | | | |
|--|------------------------|--|--|---|------------------|----------------------|--|--------------|-------------|--------|--------|-----------|-------|
| | | | | | | EC | Dates | EC | | | | | |
| FISH and WILDLIFE | | | | | | | | | | | | | |
| Suisun Marsh Wildlife Habitat Interim objectives (Footnote 4) | Chippis Is. | D10 Electrical Conductivity | 4-Agency Agreement Interim objective 28-day mean EC, mmhos/cm at Chippis Island | Wet | 10/1-12/31 | 12.5 | 1/1-5/31 | 12.5 | | | | | |
| | | | | Ab. Normal | " | 12.5 | " | 12.5 | | | | | |
| | | | | Bl. Normal | " | 12.5 | " | 12.5 | | | | | |
| | | | | Dry (deficiency) | " | 12.5 (15.6) | " | 12.5 | | | | | |
| | | | | Critical(deficiency) | " | 12.5 (15.6) | " | 12.5 | | | | | |
| Suisun Marsh Wildlife Habitat Interim objectives (Footnote 4) | D10 | Delta Outflow Index (DOI) (Footnote 5) | 4-Agency Agreement Interim objective Min mean mo. DOI with 2 of 3 reservoir flood env's encroached | All | All Year | Flow in CFS 6,600 | | | | | | | |
| | | | | | | | | | | | | | |
| Suisun Marsh Wildlife Habitat Interim objectives (Footnote 4) | D10 | Delta Outflow Index | 4-Agency Agreement Interim objective Min 14-day mean DOI for 60 consec.days | Wet | 2/1-5/31 | | | 10,000 | | | | | |
| | | | | Ab. Normal | 1/1-4/30 | | | 12,000 | | | | | |
| | | | | Bl. Normal | " | | | 12,000 | | | | | |
| Suisun Marsh Wildlife Habitat Normal objectives Sacto. R. at Collinsville Road (C-2) Montezuma Slough at National Steel (S-64) Montezuma Slough near Beldon Landing (S-49) Suisun Slough 300 ft S. of Volanti Slough (S-42) Goodyear Sl. S. of proposed Goodyear Sl. Control Structure (proposed S-75) Cordelia Slough at Cordelia-Goodyear Ditch (proposed S-97) Chadbourne Slough at Chadbourne Rd.(proposed S-21) Goodyear Slough at Morrow Island Clubhouse (S-35)(Footnote 7) Cordelia Slough, 500 ft W. of Southern Pacific crossing at Cygnus (S-33)(Footnote 7) | See Below | Control Sta. Electrical Conductivity | 4-Agency Agreement Normal objective at station Mean mo. high tide EC, mmhos/cm | All (except in deficiency period) | Dates | EC | Deficiency Period | | | | | | |
| | | | | | 10/1-31 | 19.0 | EC | EC | | | | | |
| | | | | | 11/1-30 | 16.5 | | 19.0 | | | | | |
| | | | | | 12/1-31 | 15.5 | | 16.5 | | | | | |
| | | | | | 1/1-31 | 12.5 | | 15.6 | | | | | |
| | | | | | 2/1-28 | 8.0 | | 15.6 | | | | | |
| | | | | | 3/1-31 | 8.0 | | 15.6 | | | | | |
| | | | | | 4/1-30 | 11.0 | | 14.0 | | | | | |
| | | | | | 5/1-31 | 11.0 | | 12.5 | | | | | |
| | | | | | | | | (Footnote 6) | | | | | |
| | | | | | | | | | | | | | |
| | | | | | | | | | | | | | |
| | | | | Sacramento Salmon Migration of Fall Run Adults | Rio Vista Bridge | D24 | Flow 30-day Running Average of Mean Daily Flow,CFS | | Flow in CFS | | | | |
| Wet | 1/1-31 | 2,500 | 2/1-3/15 | | | | | 3,000 | 3/16-31 | 7/1-31 | 8/1-31 | 9/1-12/31 | |
| Ab. Normal | | 2,500 | | | | | | 2,000 | | 3,000 | 3,000 | 1,000 | 5,000 |
| Bl. Normal | | 2,500 | | | | | | 2,000 | | 3,000 | 2,000 | 1,000 | 2,500 |
| Dry | | 1,500 | | | | | | 1,000 | | 2,000 | 2,000 | 1,000 | 1,500 |
| Critical | | 1,500 | | | | | | 1,000 | | 2,000 | 1,000 | 1,000 | 1,500 |
| | | | | | | | | | | | | | |
| Outmigration of Smolts | Rio Vista Bridge | D24 | Flow (Footnote 9) Historic 1930-87 flows in CFS | Wet | 4/1-30 | 22,500 | 5/1-31 | 22,000 | 6/1-30 | 18,500 | | | |
| | | | | Ab. Normal | | 22,500 | | 21,000 | | 10,500 | | | |
| | | | | Bl. Normal | | 16,500 | | 14,500 | | 7,500 | | | |
| | | | | Dry | | 12,500 | | 10,000 | | 6,500 | | | |
| | | | | Critical | | 8,500 | | 5,000 | | 2,500 | | | |
| Salmon Fry Survival | Walnut Grove | Delta Cross Channel | Operation of gates | All when Delta Outflow Index over 12,000 CFS (Footnote 5) | 1/1-3/31 closed | | | | | | | | |
| | | | | | | | | | | | | | |
| San Joaquin Salmon Outmigration of Juveniles | Vernalis | C10 | Flow (Footnote 9) Historic 1953-87 flows in CFS | Wet * | 14,000 | 13,500 | 11,000 | | | | | | |
| | | | | Ab. Normal * | 5,000 | 5,000 | 5,000 | | | | | | |
| | | | | Bl. Normal * | 2,500 | 3,500 | 3,000 | | | | | | |
| | | | | Dry * | 1,500 | 1,500 | 1,000 | | | | | | |
| | | | | Critical * | 1,000 | 1,000 | 500 | | | | | | |
| Migration of Fall Run Adult Salmon | Stockton to Turner Cut | | Dissolved Oxygen Minimum dissolved oxygen (DO) in mg/L | All* | Dates 7/1-11/30 | | | DO 6.0 | | | | | |

See last page of table for Footnotes

1-10

CSPA-242

TABLE 1 cont'd

RECOMMENDED WATER QUALITY OBJECTIVES

| Beneficial Use Protected and Location | Sampling Site # | Parameter | Description | Year Type | | Dates | Values or Limits |
|--|--|--|---|---|--|---------------------------------------|---|
| | | | | (Sacramento, unless * shows San Joaquin) | | | |
| FISH and WILDLIFE | | | | | | | |
| Delta Fishery Striped bass spawning | ✓ Prisoners Pt. | D29 Mean Daily Electrical Conductivity | Average for period not to exceed EC in mmhos/cm | All | | 4/1-5/5 | EC 0.55 |
| | ✓ Chipps Island | D10 Delta Outflow Index (DOI) | Average of the daily DOI, for the period, not less than | All | | 4/1-14 | Flow in CFS 6,700 |
| | ✓ Antioch Waterworks Intake on the San Joaquin River | D12 (near) Electrical Conductivity | Average of the mean daily EC, mmhos/cm for the period, not more than | All | | 4/15-5/5 | EC 1.5 |
| | ✓ Antioch Waterworks | D12 (near) Electrical Conductivity (Relaxation provision - replaces the above Antioch and Chipps Island objectives whenever the CVP and SWP impose deficiencies in firm supplies (Footnote 8)) | Average of mean daily EC for the period, not more than the values corresponding to the deficiencies taken (linear interpolation to be used to determine values between those shown)(Footnote 8) | All - whenever the SWP and CVP impose deficiencies in firm supplies | | Total Annual Imposed Deficiency (TAF) | 4/1-5/5 EC 1.5 1.9 2.5 3.4 4.4 10.3 25.2 |
| | | | | | | | |
| Delta Fisheries Egg and larvae survival | Chipps Is. | D10 Mean Delta Outflow for Period (Footnote 9) | DFG and USF&WS outflow recommendations in CFS | Wet Ab. Normal Bl. Normal Dry Critical | | 5/1-31 6/1-10 6/11-17 6/18-7/31 | 30,000 25,000 22,000 12,000 3,300 30,000 25,000 22,000 12,000 3,300 20,000 17,500 16,000 10,000 8,000 10,000 10,000 8,000 2,900 |
| Delta Fishery Export limit (Footnote 10) | Banks, Tracy, Contra Costa Delta Pumping Plants | 120 ^{gpc} CAP Mean export for period (Footnote 11) | Historic 1953-67 exports from Delta, except wet years, in CFS (Footnote 12) | Wet * Ab. Normal * Bl. Normal * Dry * Critical * | | 4/1-30 5/1-31 6/1-30 7/1-15 7/15-31 | 8,300 2,000 2,000 3,000 2,800 7,500 2,900 2,000 3,300 2,800 5,300 3,700 2,900 4,000 3,000 3,300 4,200 3,300 4,600 4,300 9,200 9,200 9,200 9,200 9,200 |
| Delta Fishery Flow control | Walnut Grove | Delta Cross Channel | Operation of Channel gates | Wet Ab. Normal Bl. Normal Dry Critical | | 4/1-30 5/1-31 6/1-30 7/1-31 | closed closed closed closed c/ow c/ow c/ow open open open open |

1-19

Handwritten notes:
 Delta Fishery Export limit (Footnote 10)
 Delta Fishery Flow control Walnut Grove

Handwritten notes:
 120^{gpc} CAP
 Delta Cross Channel

c/ow = gates closed, open weekends

See last page of table for Footnotes

TABLE 1 cont'd

RECOMMENDED WATER QUALITY OBJECTIVES

Footnotes

-
- Footnote 1: Only used as a control station if City of Vallejo is taking water from this source in lieu of from North Bay Aqueduct.
- Footnote 2: Sampling site numbers remain the same as in D-1485 for same sites. New sites are temporarily designated by their initials and a number.
- Footnote 3: This objective will remain in effect until Contra Costa Water District moves its intake to Clifton Court Forebay. See accompanying map.
- Footnote 4: Interim objective, superseded when parties agree facilities work. Water year types developed by State Board need no relaxation for subnormal snowmelt.
- Footnote 5: $DOI = \text{Flows at Freeport} + \text{Vernalis} - \text{Channel Depletions} + \text{Byron Bethany Irrig. Dist. Diversions} - \text{Exports}$. All in CFS.
- Footnote 6: Deficiency Period as defined in 4-Agency Agreement, except year type forecast shall be based on prediction of normal runoff instead of lowest 20 percentile of predicted runoff.
- Footnote 7: Suisun Marsh control stations proposed to be replaced if objectives cannot be met with new facilities. New location and additional facilities to be developed and objectives are to be met with additional Delta outflows until facilities are adequate.
- Footnote 8: Firm supplies of the USBR shall be any water the USBR is legally obligated to deliver under any CVP contract of 10 years or more duration, excluding the Friant Division of the CVP, subject only to dry and critical year deficiencies. Firm supplies of DWR shall be any water DWR would have delivered under Table A entitlements of water supply contracts and under prior right settlements had deficiencies not been imposed in that dry or critical year.
- Footnote 9: Daily minimum to be not less than 80% of objective.
- Footnote 10: Appropriate operating requirements to protect fish at the J. E. Skinner Fish Protective Facility and the CVP Tracy Fish Protective Facility should be presented to the State Board for incorporation in objectives during Phase III of these Bay-Delta Hearings.
- Footnote 11: Daily maximum not to exceed 120% of objective.
- Footnote 12: Exports above the values shown are permitted provided that positive downstream flows are maintained with a combined flow rate in Old and Middle rivers of at least 500 CFS.

2.0 SCOPE OF THE PLAN

2.1 Introduction

On July 7, 1987 the State Water Resources Control Board (State Board), pursuant to commitments in its 1978 Water Right Decision 1485 (D-1485) and Water Quality Control Plan (Delta Plan) for the Sacramento-San Joaquin Delta and Suisun Marsh, opened a public proceeding to receive evidence on beneficial uses and water quality issues for the San Francisco Bay and Sacramento-San Joaquin Delta Estuary (Estuary). Differing procedurally from that held for D-1485, the current hearing is to be conducted in three separate phases. To complete the first phase, this Water Quality Control Plan for Salinity for the San Francisco Bay and Sacramento-San Joaquin Delta Estuary (Plan) as well as a separate Pollutant Policy Document (PPD) have been prepared and are being distributed for review. After public comment, the Plan will be revised where necessary and adopted in the second phase, and will be considered for possible water right determinations in the third.

The scope of the Phase I proceedings covered:

- the beneficial uses being made of water flowing into, within, and from the Bay-Delta Estuary;
- the levels of protection, in terms of flow and salinity, which should be afforded these beneficial uses;
- reasonable consumptive uses made of Bay-Delta waters;
- the effects of pollutants on beneficial uses of Bay-Delta Estuary waters; and
- implementation measures to achieve the levels of protection afforded the beneficial uses.

2.2 Purpose of the Plan

This Plan establishes, where reliable data exist, numerical flow and salinity objectives^{1/} as well as a program of implementation for the beneficial uses of Bay-Delta Estuary waters. In the 1978 Water Quality Control Plan and D-1485, the State Board set flow and salinity standards to protect only the Delta and Suisun Marsh against the effects of the SWP and the CVP (see Appendix A). This Plan takes a broader view in

^{1/} For this Plan, "objectives" means the concept of enforceable numerical limits on water quality characteristics established to protect beneficial uses. The term is used in this Plan as it is used in the California Water Code, and not in the commonly understood sense of 'goals' or non-binding 'guidelines'. "Water quality objectives" in conjunction with an implementation schedule are the equivalent of EPA's "water quality standards".

*"objectives"
defined*

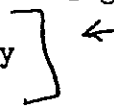

setting water quality objectives. The entire Bay and Delta as well as waters that flow into and out of the Bay-Delta Estuary are considered when developing reasonable levels of protection for all beneficial uses. The flow and salinity objectives for the Bay-Delta Estuary contained in this Plan supersede any conflicting objectives contained in the current Water Quality Control Plans (Basin Plans) of the San Francisco Bay and Central Valley Regional Water Quality Control Boards, Regions 2 and 5, respectively.

A separate Pollutant Policy Document (PPD) prepared by the State Board addresses in detail the effects of pollutants on beneficial uses in the Bay-Delta Estuary; it contains water quality objectives to be used by Regions 2 and 5 as guidance when they update their Basin Plans (see 2.5).

Both the Plan and the PPD will be subjects of the Phase II hearing, during which the public will have the opportunity to comment on both before they are finalized and formally adopted by the State Board.

2.3 Authority for Regulation of Water Quality in the Bay-Delta Estuary

The State Board is responsible for formulating and adopting state policy for water quality control (Water Code {WC} Section 13140). The Water Code states that activities and factors which may affect the quality of waters of the state "...shall be regulated to attain the highest water quality which is reasonable considering all demands being made and to be made on those waters and the total values involved..."(WC Section 13000). Through the basin planning process, the State and Regional Boards formulate and adopt Basin Plans specifying water quality objectives to ensure reasonable protection for designated beneficial uses of water (WC Sections 13170, 13240). The federal Clean Water Act (Section 303(e)) also requires states to have a continuing planning process which contains water quality standards subject to review and approval by the Environmental Protection Agency (EPA).

Under its water right authorities, the State Board ensures the reasonable protection of beneficial uses of water by placing conditions on permits and licenses for the diversion and use of waters of the state (WC Sections 1253, 1257, 1258). The State Board has continuing authority over all water rights to:

- Prevent waste, unreasonable use, method of use, or unreasonable method of diversion of water; and to
- Protect public trust uses of water.^{2/}

The State Board also has authority under the Water Code to impose specific terms and conditions on new permits to protect the public interest, prior water rights, recreation, fish and wildlife, and other interests.

^{1/} California Constitution Article X, Section 2; Imperial Irrigation District v. State Water Resources Control Board (1986) 183 Cal.App.3d 1160, 231 Cal.Rptr. 283; Water Code Sections 100, 275, 1050.

^{2/} National Audubon Society v. Superior Court (1983) 33 Cal.3d 419, 189 Cal.Rptr. 346.

The Board may in addition reserve jurisdiction under Water Code Section 1394 to amend permits in anticipation of new information. For this reason, and "...recogniz(ing) the uncertainty associated with proposed project facilities to be constructed and the need for additional information on the Bay-Delta ecosystem," the Board limited the Delta Plan in 1978 to current and near term conditions in the Delta (Delta Plan, p. I-10). The Board stated it would review the 1978 Water Quality Control Plan in about ten years. This commitment as well as recent court decisions have called for the current hearing and have expanded the scope of its proceedings.

*the 1st
10 year
review
↓
Racanelli
decision*

Specifically, in 1986, the State Court of Appeal, First District, issued a decision,^{1/} also known as the Racanelli or Delta Water Cases decision, addressing legal challenges to D-1485 and the Delta Plan. This decision directed the State Board to take a global perspective of water resources in developing water quality objectives: the State Board's duty in its water quality role is to provide reasonable protection for beneficial uses, considering all demands made on the water. The State Board's water quality function should not be equated with protection of existing water rights. Additionally, water quality objectives should not be limited to what the State Board can enforce under its water right authority. The decision recognized, however, that an implementing program may be a lengthy and complex process that requires significant time intervals and action by entities over which the State Board has little or no control.

Both the State Board's authority and the court's recent decision have guided the reassessment developed in this Plan. } ←

2.4 Geographic Limits

The geographic limits for the water quality objectives set in the Plan include:

2.4.1 San Francisco Bay

San Francisco Bay (Bay), with its approximately 300,000 acres of water surface area, is located at the mouth of the Sacramento-San Joaquin Delta, the outlet for the Sacramento and San Joaquin rivers. These rivers drain about forty percent of the state. The Bay is composed of four primary embayments which are: (1) the south Bay, stretching from the Oakland Bay Bridge on the north to Mountain View on the southern edge; (2) the central Bay, the area between the Richmond-San Rafael Bay Bridge and the Oakland Bay Bridge; (3) the San Pablo Bay to the north, encompassing the area from the Richmond-San Rafael Bay Bridge on the south side to the Petaluma River on the north and the Carquinez Strait on the east; and (4) the area between the entrance to the Carquinez Strait and Chipps Island, encompassing the Carquinez Strait, Suisun Bay, Grizzly Bay, and Honker Bay.

^{1/} United States v. State Water Resources Control Board (1986) 182 Cal.App.3d 82, 227 Cal.Rptr. 161

2.4.2 Sacramento-San Joaquin Delta

The Delta, as defined in Water Code Section 12220, is roughly a triangular 738,000-acre area extending from Chipps Island near Pittsburg on the west to Sacramento on the north and to the Vernalis gaging station on the San Joaquin River in the south. Also included within the Delta boundary are the Harvey O. Banks Pumping Plant and the Tracy Pumping Plant, SWP and CVP facilities. Although water from the Delta is diverted for use in central and southern California, the water quality objectives for export uses are set at the pumping plants in the Delta. (The Tulare Lake Basin is not being considered tributary to the Estuary.)

2.4.3 Suisun Marsh

The 85,000-acre Suisun Marsh, located in southern Solano County south of the cities of Fairfield and Suisun City, is bordered on the south by Suisun Bay, Honker Bay, and the confluence of the Sacramento and San Joaquin Rivers; on the west by State Highway 21 running from Benecia to Cordelia; on the north by Cordelia Road to the city of Suisun; and on the east from Denverton along Shiloh Road to Collinsville.

2.5 Pollutants in the Bay-Delta Estuary

The information on pollutants received in Phase I of the hearing has been used in this Plan only to differentiate, where possible, the effects of flow and salinity on beneficial uses from those of pollutants. As noted, a separate Pollutant Policy Document (PPD) establishes state policy for pollutant regulation in the waters of the Bay-Delta Estuary, and will be used by Regions 2 and 5 in updating portions of their Basin Plans.

The PPD also identifies and characterizes pollutants with the greatest potential biological significance in the Bay-Delta Estuary. Point, nonpoint and riverine sources of pollutants presented during the hearing are discussed as well as the effects of these pollutants on public health and biological resources. The PPD recommends that water quality objectives be adopted for certain identified priority pollutants. Where information is insufficient to set water quality objectives, an approach is established for developing such objectives. Other related issues that the Regional Boards requested the State Board to resolve, such as dredging spoils, trihalomethanes, cumulative pesticide loads and database evaluation, are also addressed.

2.6 California Environmental Quality Act (CEQA)

Pursuant to Section 15251(g) Title 14, California Code of Regulations (C.C.R.), the State Board's Water Quality Control (Basin) Planning Program is a "certified program" by the Secretary for Resources. As a certified program it is exempt from the requirements of preparing Environmental Impact Reports (EIR). However, the Program remains subject to other provisions in CEQA, such as the policy of avoiding significant adverse effects on the environment when feasible.

The Draft Water Quality Control Plan "globally balances" the competing uses of Bay-Delta waters and provides reasonable protection to each use. It identifies alternatives and mitigation measures to avoid or reduce any significant or potentially significant effects that this Plan might have on the environment. Therefore, this Plan meets the requirements of a substitute for an EIR as set forth in 14 C.C.R. Section 15252.



3.0 BASIN DESCRIPTION

3.1 Introduction

The Estuary and adjacent areas described in this Plan include:

- o The Delta (Figure 3.1-1);
- o The Delta's tributary areas, that is, the Sacramento River, the Central Sierra, the San Joaquin River basins^{1/} (Figure 3.1-2); and
- o The San Francisco Bay and hydrologic Basin (Figure 3.1-3).

Together, the Estuary and tributary basins provide about two-thirds of all the water used in California, including 40 percent of the state's drinking water.

This chapter outlines the hydrologic conditions of the Estuary by providing a detailed description of each area's:

1. Physical Description--the geographical and legal dimensions;
2. Hydrology--the characteristics and nature of water movement;
3. Unimpaired Flow Conditions--the maximum amount of flow available in existent channels without consideration of diversions or storage (3.1.1); and
4. Current Flow Conditions--the water flow conditions as they now exist, or, where appropriate, as they have been affected by the Delta Plan (3.1.2).

3.1.1 Unimpaired Flow Conditions

Unimpaired flow conditions within the Estuary are the estimated amounts of water that would be available if there were no upstream impoundments or diversions of runoff but current upstream and Delta channel configurations existed (SWRCB,3,8). Unimpaired conditions could also be defined as the present day conditions if all storage and diversion were to cease on a short-term basis (T,II,114:2-15). "Natural" or "true natural flow" conditions, on the other hand, are defined as those existing in the late 1700's at the time of the first Spanish exploration of California (SWC,276,3). Unlike natural flow, it is assumed for unimpaired flow conditions that: (1) the present levees, bypasses and channel configuration are in place; (2) the natural flood basins and their marshes are drained; and (3) that only those riparian forests and tule marshes that currently exist are consuming water (SWC,262,6A2-21). Unimpaired flow conditions as well as current flow conditions are measured over a given period of time--the water year (see Section 3.1.3).

^{1/} The Tulare Lake Basin (Basin 5D), although part of the Central Valley, is not considered to be tributary to the Delta.

FIGURE 3.1.-1 Boundary of the Bay-Delta Estuary and locations of diversion points (from: SWRCB, 3, 5)

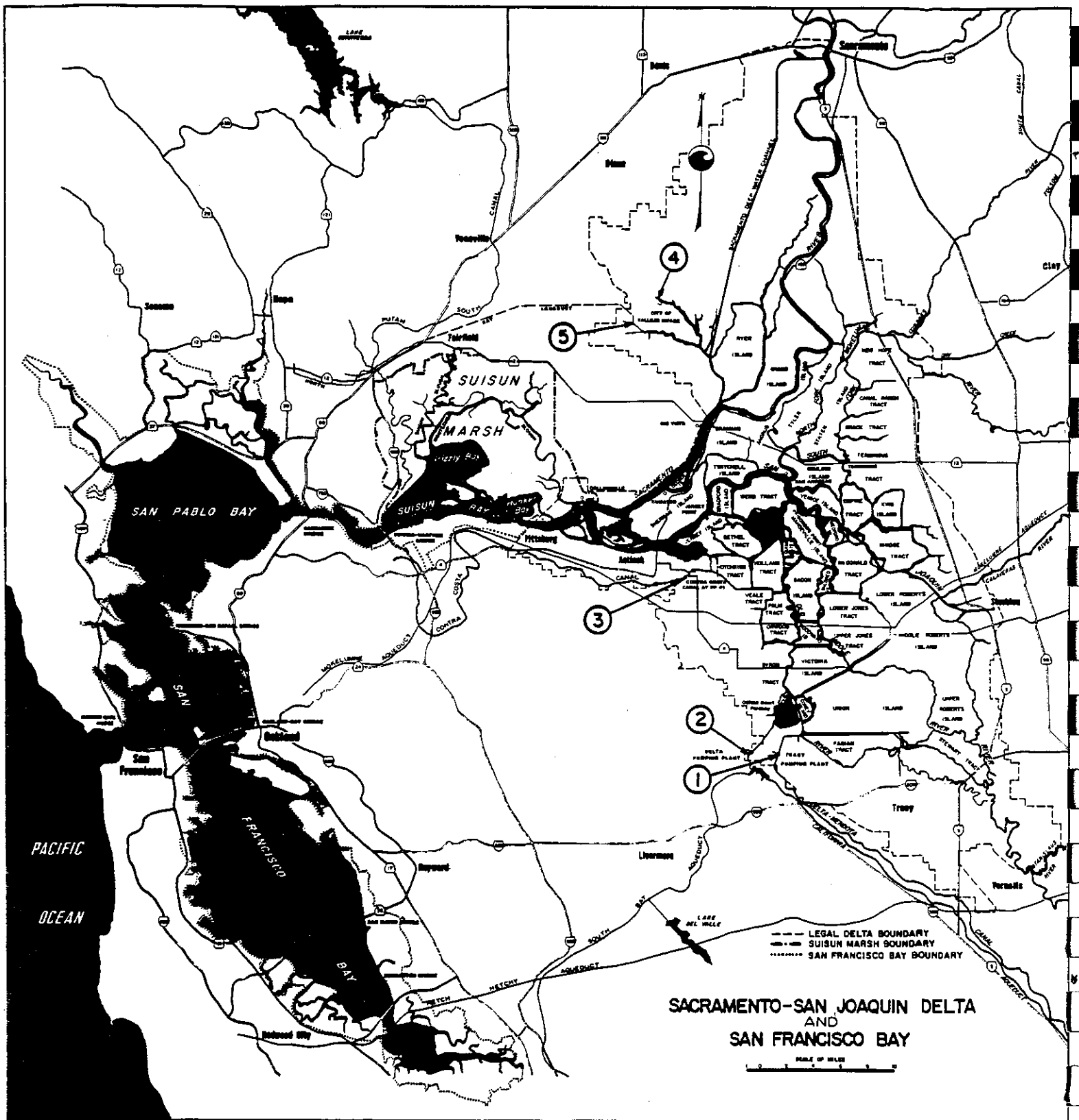
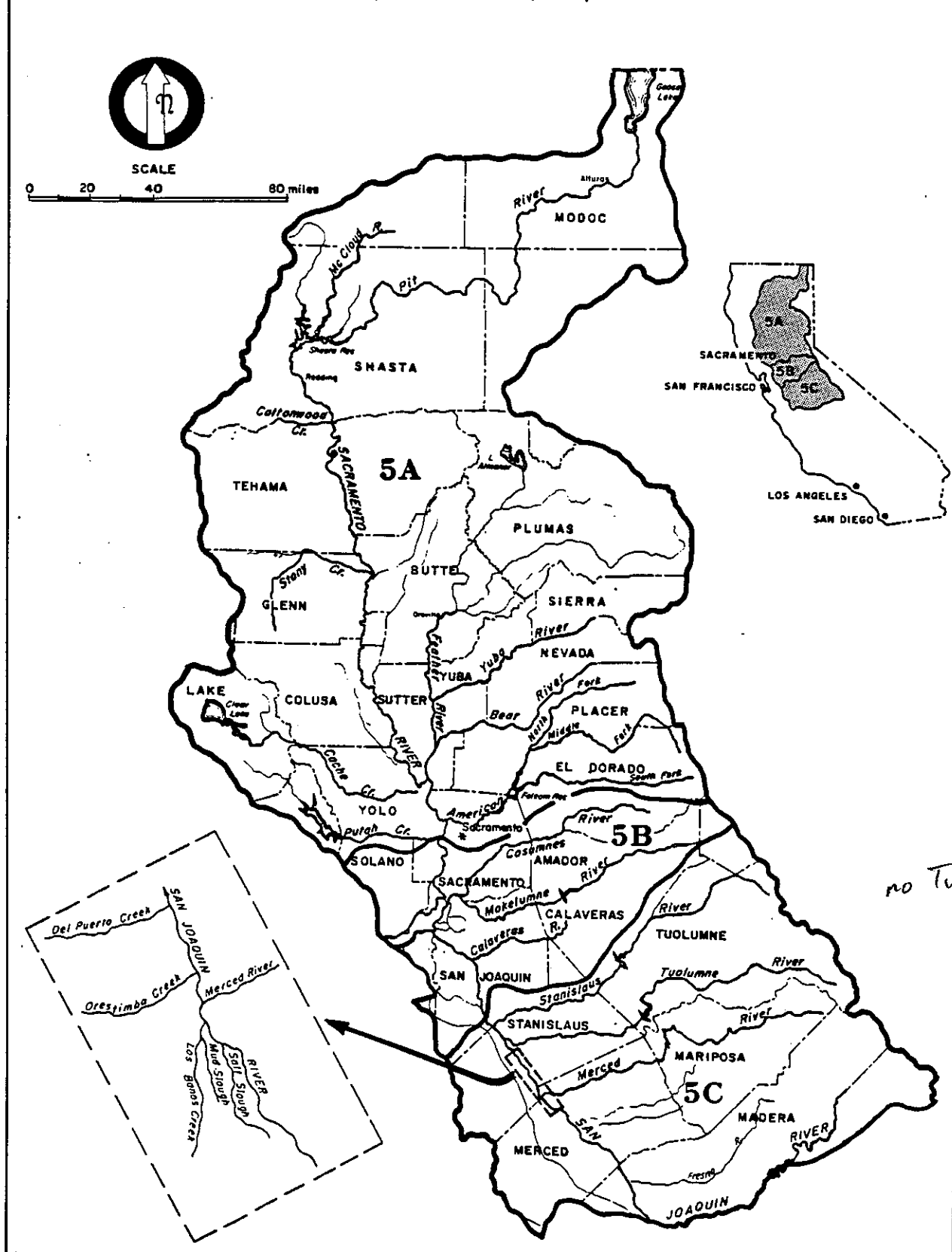
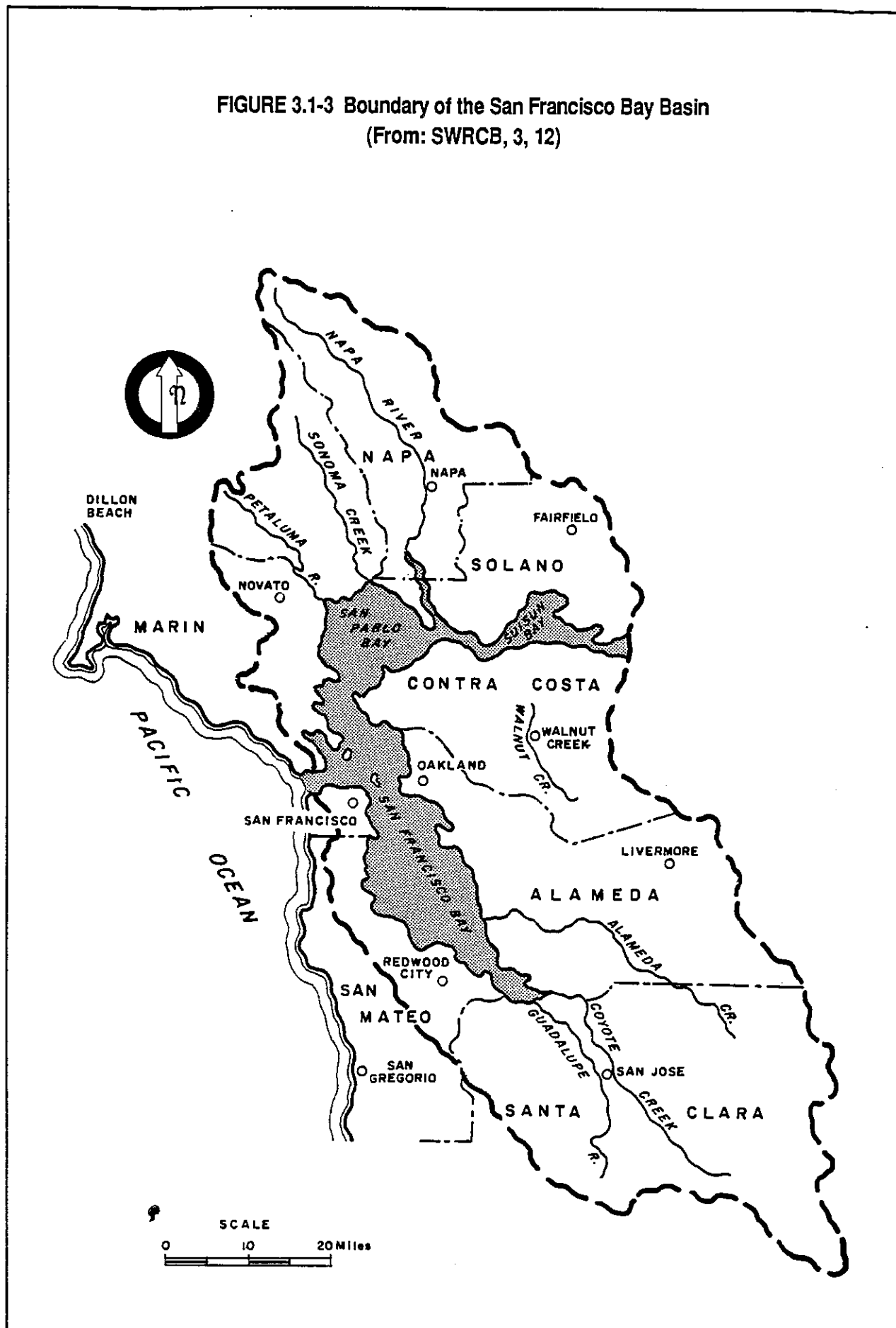

FIGURE 3.1-2 Boundaries of the Sacramento River (5A), Central Sierra and Delta (5B), and San Joaquin (5C) basins
(From: RWQCB 5, 1975)



no Tulare Lake Basin

FIGURE 3.1-3 Boundary of the San Francisco Bay Basin
(From: SWRCB, 3, 12)



3.1.2 Current Flow Conditions

Current flow conditions are those estimated by DWR's 1990 level of development operations study which uses the unimpaired basin inflows for the hydrologic period 1922-1978 and modifies these based on reservoir operations and consumptive demands reflective of current conditions (1990). The operations study is run to meet the existing 1978 Delta Plan and D-1485 water quality objectives. Upstream storage releases, diversions and exports also depend, to some degree, on conditions established by the Delta Plan. To the extent, for example, that specified minimum outflows from the Delta are mandated by the Delta Plan and D-1485, the Sacramento River Basin is directly affected by the upstream storage releases that provide the required outflow amounts. The San Francisco Bay is likewise directly affected by Delta outflows not directly regulated even though its waters are. In discussing 'current flow conditions', it will therefore be necessary to describe the extent to which the Delta Plan influences water amounts available from storage releases and diversions in the Estuary.

At the end of this section a table comparing unimpaired flow and current flow conditions by water year type provides a summary of the actual amounts of water available in each basin.

3.1.3 Water Year Types

3.1.3.1 Classifying Water Years for a Basin

Water year (WY) classifications provide estimates of the amount of water in a basin that is available from precipitation and snowmelt runoff to meet the needs of beneficial uses. Most often, the classification means a water year of 12 months, but it can refer to a shorter period. The wetter classifications indicate the high probability that enough water will be available to meet the needs of all beneficial uses. Drier classifications indicate that, for at least part of the time, the demand could be greater than the natural supply of water needed to support beneficial uses fully.

3.1.3.2 1978 Delta Plan Water Year Classifications

- Four River Index

The current hydrologic classification established by D-1485 is divided into five water year types: wet, above normal, below normal, dry, and critically dry (Figure 3.1.3.2-1) (SWRCB, 13, III-10). This system is based on the "Four River Index"—the annual unimpaired runoff to the Sacramento Valley from its four principal tributaries, the Sacramento, Feather, Yuba, and American rivers.

FIGURE 3.1.3.2-1 Water Quality Control Plan Hydrologic Classification

Year classification shall be determined by the forecast of Sacramento Valley unimpaired runoff for the current water year (October 1 of the preceding calendar year through September 30 of the current calendar year) as published in California Department of Water Resources Bulletin 120 for the sum of the following locations: Sacramento River above Bend Bridge, near Red Bluff; Feather River, total inflow to Oroville Reservoir; Yuba River at Smartville; American River, total inflow to Folsom Reservoir. Preliminary determinations of year classification shall be made in February, March and April with final determination in May. These preliminary determinations shall be based on hydrologic conditions to date plus forecasts of future runoff assuming normal precipitation for the remainder of the water year.

| YEAR TYPE | RUNOFF, MILLIONS OF ACRE-FEET |
|----------------------------|---|
| Wet ^{1/} | equal to or greater than 19.6 (except equal to or greater than 22.5 in a year following a critical year). ^{3/} |
| Above Normal ^{1/} | greater than 15.7 and less than 19.6 (except greater than 15.7 and less than 22.5 in a year following a critical year). ^{3/} |
| Below Normal ^{1/} | equal to or less than 15.7 and greater than 12.5 (except in a year following a critical year). ^{3/} |
| Dry | equal to or less than 12.5 and greater than 10.2 (except equal to or less than 15.7 and greater than 12.5 in a year following a critical year). ^{3/} |
| Critical | equal to or less than 10.2 (except equal to or less than 12.5 in a year following a critical year). ^{3/} |

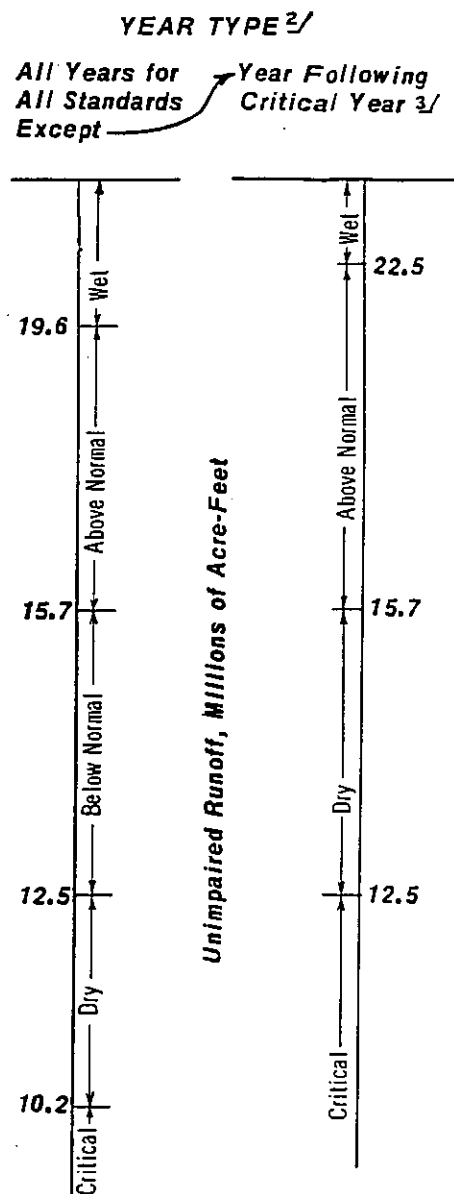

- ^{1/} Any otherwise wet, above normal, or below normal year may be designated a subnormal snowmelt year whenever the forecast of April through July unimpaired runoff reported in the May issue of Bulletin 120 is less than 5.9 million acre-feet.
- ^{2/} The year type for the preceding water year will remain in effect until the initial forecast of unimpaired runoff for the current water year is available.
- ^{3/} "Year following critical year" classification does not apply to Agricultural, Municipal and Industrial standards.

This classification defines normal inflow, or the boundary between a below normal and an above normal water year, as the logarithmic mean of the Sacramento Basins Four River Index for the period of 1922 through 1971. The logarithmic mean is also the 50th percentile value. Half the years exceed this value and half the years are less than this value. In other words, there is a 50 percent chance that flows will exceed 15.7 million acre feet (MAF), the logarithmic mean for the Sacramento Basin. The boundary between an above normal year and a wet year was set at the 70 percent probability, 19.7 MAF. In years following a critical year the 80 percent value, or 22.5 MAF, was used. The classifications of dry and critically dry years were developed by identifying the Four River Index values which had a potential for water supply shortages or critical water supply shortages. As a result of an analysis by DWR, it was determined that for the Four River Index the appropriate definition of dry and critically dry years should be 12.5 and 10.2 MAF, respectively (DWR, Exhibit 1).

3.1.3.3 Revised Water Year Types: An Index for Each Basin

The current hydrologic classification system does not provide an adequate indication of the quantity of water available in the Delta. The current water year measurements apply only to the Sacramento River Basin; the San Joaquin Basin needs to be included. The timing of seasonal flow also should be addressed. Two different water years, for instance, can have the same annual runoff; however, the runoff can come from separate seasons, that is, from winter flow or spring snowmelt. Planning for water supplies should account for these and other conditions.

In addressing these problems, the Department of Water Resources has suggested a revised hydrologic classification which forecasts unimpaired runoff during the period of April through July to determine the runoff classification for any particular year (T,I,99:13-20). South Delta Water Agency (SDWA) has also developed a separate classification for the San Joaquin River Basin (SDWA, 4, 23-25).

The State Board has taken these and other recommendations and developed two new classification systems, one for each Basin (Figures 3.1.3.3-1 and 3.1.3.3-2)^{1/}. The new classifications include the following:

^{1/} The water year type designations for the Sacramento and San Joaquin River basins were developed by first determining the frequency an estimated unimpaired flow level occurred during April through July for the years 1906 through 1987 (Figure 3.1.3.3-3). Then, using the same percentage of occurrence as the Delta Plan, the water year types (i.e., wet, above normal, below normal, dry and critical for average years and for years following critical years) were classified for both basins.

**FIGURE 3.1.3.3-1
SACRAMENTO RIVER BASIN
APRIL THROUGH JULY HYDROLOGIC CLASSIFICATION**

The Sacramento River Basin April through July hydrologic classification shall be determined by the forecast of Sacramento Valley unimpaired runoff for the year's April through July period as published in California Department of Water Resources Bulletin 120 for the sum of the following locations: Sacramento River above Bend Bridge, near Red Bluff; Feather River, total inflow to Oroville Reservoir; Yuba River at Smartville; American River, total inflow to Folsom Reservoir. Preliminary determinations of the classification shall be based on the April through July hydrologic conditions to date plus forecasts of future runoff assuming normal precipitation for the remainder of the April through July period.

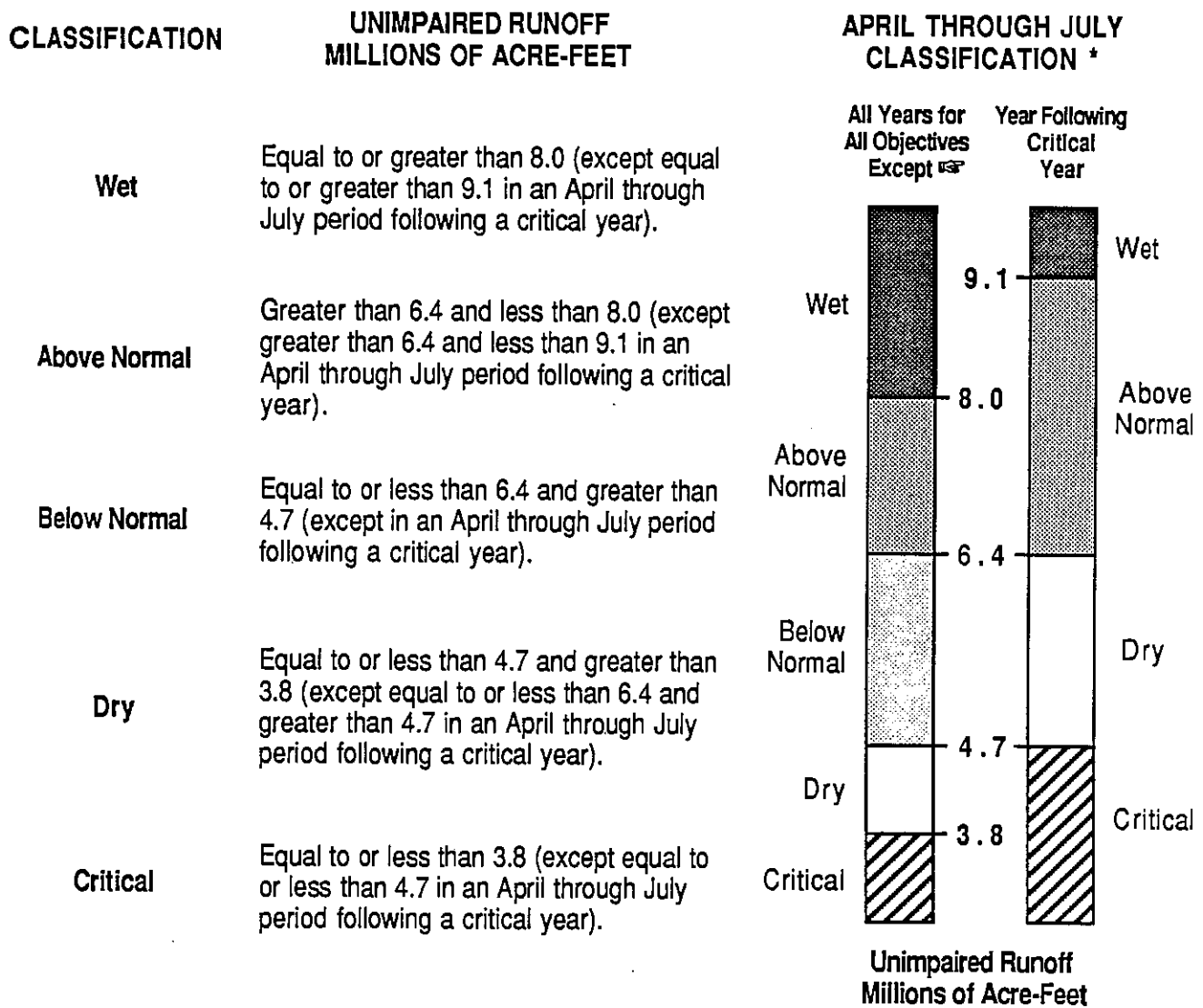

* The April through July classification for the preceding water year will remain in effect until the initial forecast of unimpaired runoff for the current water year's April through July classification is available.

**FIGURE 3.1.3.3-2
SAN JOAQUIN RIVER BASIN
APRIL THROUGH JULY HYDROLOGIC CLASSIFICATION**

The San Joaquin River Basin April through July hydrologic classification shall be determined by the forecast of San Joaquin Valley unimpaired runoff for the year's April through July period as published in California Department of Water Resources Bulletin 120 for the sum of the following locations: Stanislaus River, total inflow to New Melones Reservoir; Tuolumne River, total inflow to Don Pedro Reservoir; Merced River, total inflow to Exchequer Reservoir; San Joaquin River, total inflow to Millerton Lake. Preliminary determinations of the classification shall be based on the April through July hydrologic conditions to date plus forecasts of future runoff assuming normal precipitation for the remainder of the April through July period.

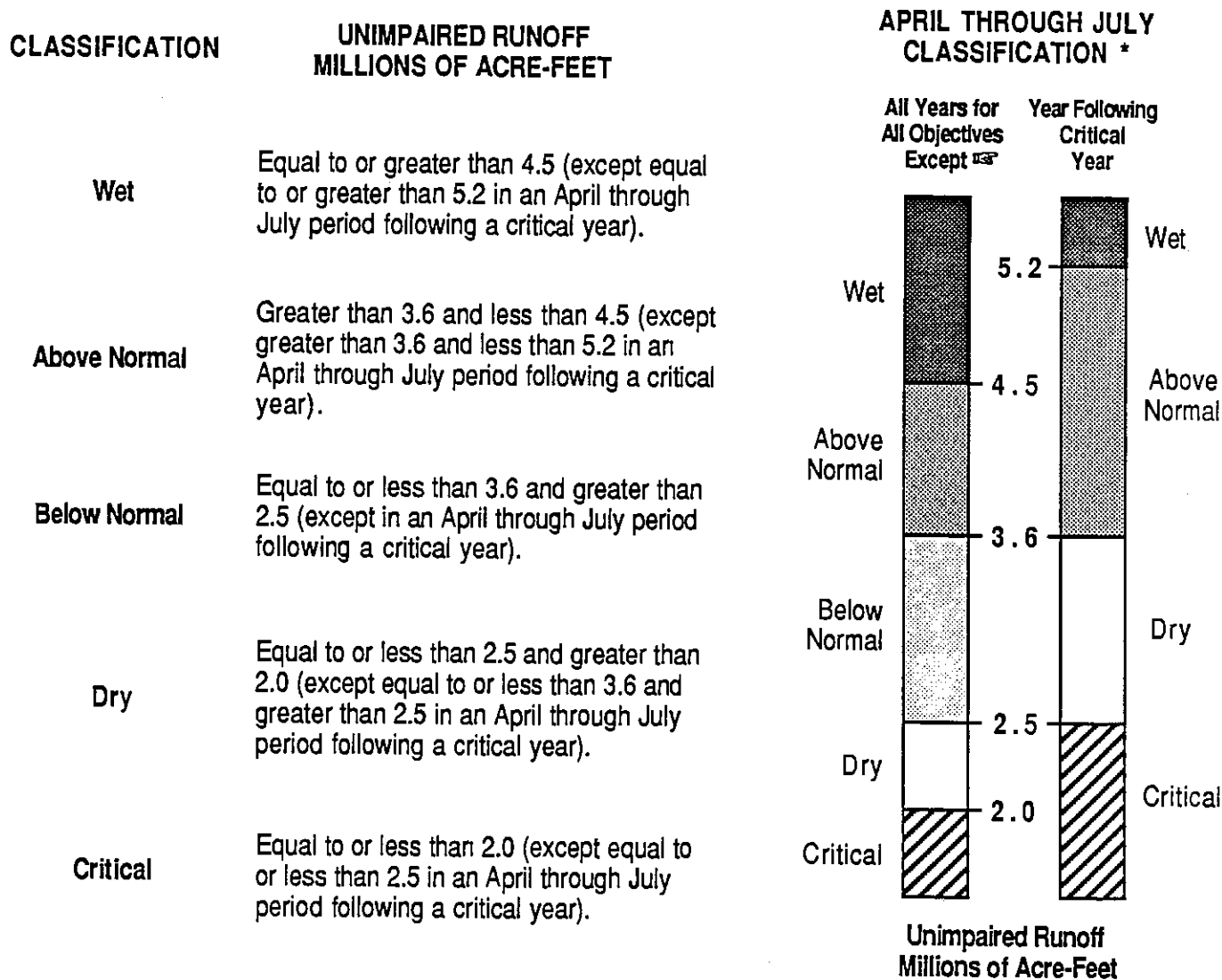

* The April through July classification for the preceding water year will remain in effect until the initial forecast of unimpaired runoff for the current water year's April through July classification is available.

99.99 99.9 99.8 99 98 95 90 80 70 60 50 40 30 20 10 5 2 1 0.5 0.2 0.1 0.05 0.01

FIGURE 3.1.3.3-3 ESTIMATED WATER YEAR AND APRIL THROUGH JULY UNIMPAIRED FLOW FOR THE SACRAMENTO AND SAN JOAQUIN VALLEYS, 1906-1987

| ESTIMATED UNIMPAIRED FLOWS | | | | |
|----------------------------|-------------------|------------|--------------------|------------|
| PROB. OF FLOW VALUE \leq | SACRAMENTO VALLEY | | SAN JOAQUIN VALLEY | |
| | WATER YEAR | APRIL-JULY | WATER YEAR | APRIL-JULY |
| 80 | 23.5 | 9.1 | 7.9 | 5.2 |
| 70 | 21.0 | 8.0 | 6.8 | 4.5 |
| 50 | 16.8 | 6.4 | 5.3 | 3.6 |
| 22 | 12.5 | 4.7 | 3.7 | 2.5 |
| 11 | 10.2 | 3.8 | 3.0 | 2.0 |

UNIMPAIRED FLOW (MAF)

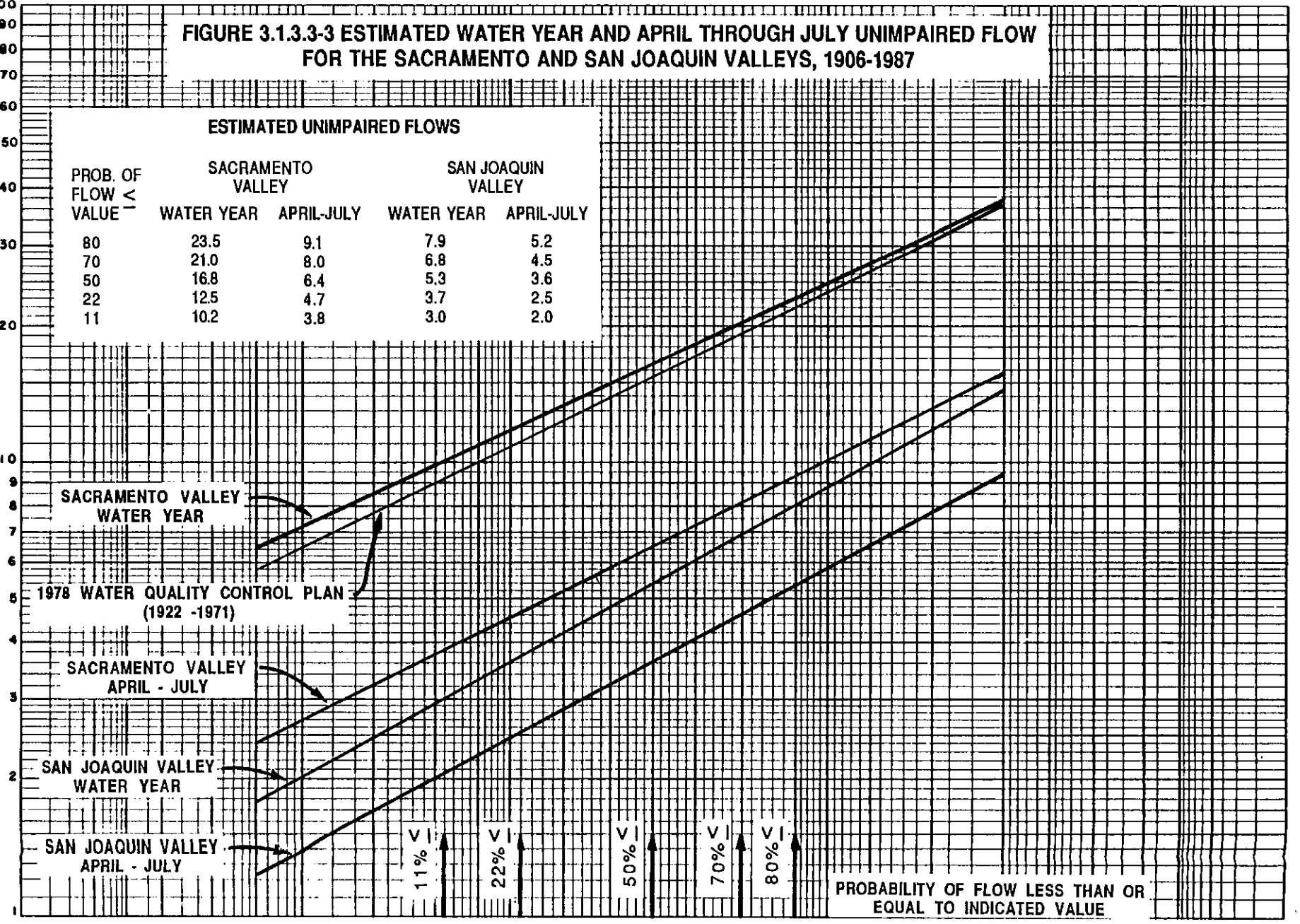

SACRAMENTO VALLEY WATER YEAR

1978 WATER QUALITY CONTROL PLAN (1922 -1971)

SACRAMENTO VALLEY APRIL - JULY

SAN JOAQUIN VALLEY WATER YEAR

SAN JOAQUIN VALLEY APRIL - JULY

11% \leq
22% \leq
50% \leq
70% \leq
80% \leq

PROBABILITY OF FLOW LESS THAN OR EQUAL TO INDICATED VALUE

0.01 0.05 0.1 0.2 0.5 1 2 5 10 20 30 40 50 60 70 80 90 95 98 99 99.8 99.9 99.99

3-10

CSPA-242

- The Sacramento Basin index incorporates its four principal tributaries--the Sacramento, Feather, Yuba, and the American Rivers.
- A separate classification system developed for the San Joaquin River Basin incorporates its four principal tributaries--the Stanislaus, Tuolumne, Merced, and San Joaquin rivers.
- The San Joaquin River Basin water year classification is used for water quality objectives in the southern Delta and for export objectives.
- An 82 year period, 1906 through 1987, is used to determine the classification boundaries for both river basins, instead of the 50 year period 1922 through 1971.
- The April through July unimpaired flows determine runoff classification systems for both the Sacramento and San Joaquin river systems. The subnormal snowmelt designation has been eliminated.
- The "year following critical year" designation is based on the previous year's April through July classification.
- The "year following critical year" designation applies to all objectives, not just those for fish and wildlife.

These revisions add information to, but do not greatly change, the conditions of hydrologic classification used in the 1978 Delta Plan.

3.1.3.4 Differences in Classification

Three possible classifications for the Sacramento and the San Joaquin River basins have been considered (see Tables 3.1.3.4-1 through -3):

1. The 1978 Delta Plan classification which is based on an entire water year, but only for the period of hydrologic record of 1922 through 1971.
2. A revised classification which is also based on an entire water year, but for the expanded period of 1906 through 1987.
3. The proposed classification which is based on the months of April to July, but also for the expanded period of 1906 through 1987.

There are only minor differences between the three. When, for example, the classification is expanded to include the period of 1906 to 1987, some relatively small changes in percentage of occurrence result (Table 3.1.3.4-3).

TABLE 3.1.3.4-1

SACRAMENTO RIVER BASIN FOUR RIVER INDEX AND HYDROLOGIC CLASSIFICATIONS *

| ----- WATER YEAR ----- | | | | ----- APRIL THROUGH JULY ----- | | | -----D-1485 **----- |
|------------------------|-------------------------|---------------------|---------------------------|--------------------------------|---------------------|---------------------------|-----------------------|
| WATER YEAR | UNIMPAIRED RUNOFF (TAF) | PERCENT OF LOG MEAN | WATER YEAR CLASSIFICATION | UNIMPAIRED RUNOFF (TAF) | PERCENT OF LOG MEAN | APRIL-JULY CLASSIFICATION | D-1485 CLASSIFICATION |
| 1906 | 26709 | 159% | W | 12924 | 202% | W | W |
| 1907 | 33705 | 201% | W | 13450 | 210% | W | W |
| 1908 | 14773 | 88% | BN | 5605 | 88% | BN | BN/SS |
| 1909 | 30681 | 183% | W | 8985 | 140% | W | W |
| 1910 | 20122 | 120% | AN | 6116 | 96% | BN | W |
| 1911 | 26384 | 157% | W | 13119 | 205% | W | W |
| 1912 | 11410 | 68% | D | 5646 | 88% | BN | D |
| 1913 | 12847 | 76% | BN | 6287 | 98% | BN | BN |
| 1914 | 27812 | 166% | W | 10077 | 157% | W | W |
| 1915 | 23860 | 142% | W | 11416 | 178% | W | W |
| 1916 | 24143 | 144% | W | 8886 | 139% | W | W |
| 1917 | 17261 | 103% | AN | 9138 | 143% | W | AN |
| 1918 | 10997 | 65% | D | 4888 | 76% | BN | D |
| 1919 | 15657 | 93% | BN | 6775 | 106% | AN | BN |
| 1920 | 9200 | 55% | C | 4910 | 77% | BN | C |
| 1921 | 23801 | 142% | W | 7523 | 118% | AN | W |
| 1922 | 17982 | 107% | AN | 10568 | 165% | W | AN |
| 1923 | 13209 | 79% | BN | 6271 | 98% | BN | BN |
| 1924 | 5737 | 34% | C | 1936 | 30% | C | C |
| 1925 | 15994 | 95% | D | 6511 | 102% | AN | AN |
| 1926 | 11766 | 70% | D | 4791 | 75% | BN | D |
| 1927 | 23835 | 142% | W | 8750 | 137% | W | W |
| 1928 | 16763 | 100% | BN | 5860 | 92% | BN | AN/SS |
| 1929 | 8403 | 50% | C | 3836 | 60% | D | C |
| 1930 | 13516 | 80% | D | 4652 | 73% | D | BN/D |
| 1931 | 6095 | 36% | C | 2088 | 33% | C | C |
| 1932 | 13118 | 78% | D | 6238 | 97% | D | BN/D |
| 1933 | 8939 | 53% | C | 4665 | 73% | D | C |
| 1934 | 8631 | 51% | C | 2452 | 38% | C | C |
| 1935 | 16590 | 99% | D | 9692 | 151% | W | AN |
| 1936 | 17350 | 103% | AN | 6407 | 100% | AN | AN |
| 1937 | 13335 | 79% | BN | 7238 | 113% | AN | BN |
| 1938 | 31828 | 189% | W | 12935 | 202% | W | W |
| 1939 | 8183 | 49% | C | 3039 | 47% | C | C |
| 1940 | 22434 | 134% | AN | 6927 | 108% | AN | W/AN |
| 1941 | 27080 | 161% | W | 9770 | 153% | W | W |
| 1942 | 25237 | 150% | W | 9931 | 155% | W | W |
| 1943 | 21124 | 126% | W | 6897 | 108% | AN | W |
| 1944 | 10433 | 62% | D | 4934 | 77% | BN | D |
| 1945 | 15063 | 90% | BN | 5919 | 92% | BN | BN |
| 1946 | 17619 | 105% | AN | 5971 | 93% | BN | AN |
| 1947 | 10383 | 62% | D | 3827 | 60% | D | D |
| 1948 | 15752 | 94% | BN | 9545 | 149% | W | AN |

TABLE 3,1,3,4-1 (continued)
SACRAMENTO RIVER BASIN FOUR RIVER INDEX AND HYDROLOGIC CLASSIFICATIONS *

| WATER YEAR | | | | APRIL THROUGH JULY | | | D-1485 ** |
|------------|-------------------------|---------------------|---------------------------|-------------------------|---------------------|---------------------------|-----------------------|
| WATER YEAR | UNIMPAIRED RUNOFF (TAF) | PERCENT OF LOG MEAN | WATER YEAR CLASSIFICATION | UNIMPAIRED RUNOFF (TAF) | PERCENT OF LOG MEAN | APRIL-JULY CLASSIFICATION | D-1485 CLASSIFICATION |
| 1949 | 11969 | 71% | D | 5587 | 87% | BN | D |
| 1950 | 14442 | 86% | BN | 6720 | 105% | AN | BN |
| 1951 | 22945 | 137% | W | 5418 | 85% | BN | W/SS |
| 1952 | 28600 | 170% | W | 13676 | 214% | W | W |
| 1953 | 20086 | 120% | AN | 8260 | 129% | W | W |
| 1954 | 17427 | 104% | AN | 6813 | 106% | AN | AN |
| 1955 | 10986 | 65% | D | 5067 | 79% | BN | D |
| 1956 | 29890 | 178% | W | 8604 | 134% | W | W |
| 1957 | 14888 | 89% | BN | 6294 | 98% | BN | BN |
| 1958 | 29711 | 177% | W | 12241 | 191% | W | W |
| 1959 | 12055 | 72% | D | 3837 | 60% | D | D |
| 1960 | 13059 | 78% | BN | 4651 | 73% | D | BN/SS |
| 1961 | 11976 | 71% | D | 4388 | 69% | D | D |
| 1962 | 15116 | 90% | BN | 6234 | 97% | BN | BN |
| 1963 | 22993 | 137% | W | 10091 | 158% | W | W |
| 1964 | 10917 | 65% | D | 4374 | 68% | D | D |
| 1965 | 25665 | 153% | W | 8134 | 127% | W | W |
| 1966 | 12955 | 77% | BN | 4836 | 76% | BN | BN/SS |
| 1967 | 24060 | 143% | W | 11016 | 172% | W | W |
| 1968 | 13639 | 81% | BN | 4114 | 64% | D | BN/SS |
| 1969 | 26839 | 160% | W | 10628 | 166% | W | W |
| 1970 | 24060 | 143% | W | 4356 | 68% | D | W/SS |
| 1971 | 22775 | 136% | W | 8914 | 139% | W | W |
| 1972 | 13421 | 80% | BN | 4991 | 78% | BN | BN/SS |
| 1973 | 20029 | 119% | AN | 6371 | 100% | BN | W |
| 1974 | 32554 | 194% | W | 9769 | 153% | W | W |
| 1975 | 19227 | 114% | AN | 8960 | 140% | W | AN |
| 1976 | 8184 | 49% | C | 2720 | 43% | C | C |
| 1977 | 5105 | 30% | C | 1925 | 30% | C | C |
| 1978 | 23826 | 142% | W | 8077 | 126% | AN | W |
| 1979 | 12435 | 74% | D | 5658 | 88% | BN | D |
| 1980 | 22339 | 133% | W | 6000 | 94% | BN | W |
| 1981 | 11140 | 66% | D | 3653 | 57% | C | D |
| 1982 | 33338 | 198% | W | 11745 | 184% | W | W |
| 1983 | 37798 | 225% | W | 13705 | 214% | W | W |
| 1984 | 22352 | 133% | W | 5518 | 86% | BN | W/SS |
| 1985 | 11045 | 66% | D | 4005 | 63% | D | D |
| 1986 | 25735 | 153% | W | 5358 | 84% | BN | W/SS |
| 1987 | 9193 | 55% | C | 2778 | 43% | C | C |

* W - Wet; AN - Above Normal; BN - Below Normal; D - Dry; C - Critically Dry; SS - Subnormal Snowmelt

** In some cases a year will have a dual classification - one classification for fish and wildlife standards and the next wetter classification for agricultural and municipal and industrial standards

TABLE 3.1.3.4-2

SAN JOAQUIN RIVER BASIN FOUR RIVER INDEX AND HYDROLOGIC CLASSIFICATIONS *

| ----- WATER YEAR ----- | | | | ----- APRIL THROUGH JULY ----- | | | ----- D-1485 ** ----- |
|------------------------|-------------------------|---------------------|---------------------------|--------------------------------|---------------------|---------------------------|-----------------------|
| WATER YEAR | UNIMPAIRED RUNOFF (TAF) | PERCENT OF LOG MEAN | WATER YEAR CLASSIFICATION | UNIMPAIRED RUNOFF (TAF) | PERCENT OF LOG MEAN | APRIL-JULY CLASSIFICATION | D-1485 CLASSIFICATION |
| 1906 | 12427 | 234% | W | 9238 | 257% | W | W |
| 1907 | 11825 | 223% | W | 7606 | 211% | W | W |
| 1908 | 3327 | 63% | D | 2167 | 60% | D | BN/SS |
| 1909 | 8972 | 169% | W | 5906 | 164% | W | W |
| 1910 | 6645 | 125% | AN | 3622 | 101% | AN | W |
| 1911 | 11481 | 217% | W | 7522 | 209% | W | W |
| 1912 | 3211 | 61% | D | 2572 | 71% | BN | D |
| 1913 | 2995 | 57% | C | 2340 | 65% | D | BN |
| 1914 | 8691 | 164% | W | 5672 | 158% | W | W |
| 1915 | 6406 | 121% | AN | 4949 | 137% | W | W |
| 1916 | 8382 | 158% | W | 5497 | 153% | W | W |
| 1917 | 6663 | 126% | AN | 4837 | 134% | W | AN |
| 1918 | 4589 | 87% | BN | 3397 | 94% | BN | D |
| 1919 | 4097 | 77% | BN | 2987 | 83% | BN | BN |
| 1920 | 4096 | 77% | BN | 3289 | 91% | BN | C |
| 1921 | 5900 | 111% | AN | 3840 | 107% | AN | W |
| 1922 | 7677 | 145% | W | 5996 | 167% | W | AN |
| 1923 | 5512 | 104% | AN | 3954 | 110% | AN | BN |
| 1924 | 1500 | 28% | C | 1034 | 29% | C | C |
| 1925 | 5506 | 104% | AN | 3926 | 109% | AN | AN |
| 1926 | 3488 | 66% | D | 2560 | 71% | BN | D |
| 1927 | 6501 | 123% | AN | 4564 | 127% | W | W |
| 1928 | 4367 | 82% | BN | 2639 | 73% | BN | AN/SS |
| 1929 | 2844 | 54% | C | 2292 | 64% | D | C |
| 1930 | 3252 | 61% | C | 2437 | 68% | D | BN/D |
| 1931 | 1660 | 31% | C | 1178 | 33% | C | C |
| 1932 | 6630 | 125% | AN | 4686 | 130% | AN | BN/D |
| 1933 | 3341 | 63% | D | 2767 | 77% | BN | C |
| 1934 | 2286 | 43% | C | 1259 | 35% | C | C |
| 1935 | 6410 | 121% | AN | 5025 | 140% | AN | AN |
| 1936 | 6487 | 122% | AN | 4379 | 122% | AN | AN |
| 1937 | 6527 | 123% | AN | 4655 | 129% | W | BN |
| 1938 | 11268 | 213% | W | 7358 | 204% | W | W |
| 1939 | 2905 | 55% | C | 1831 | 51% | C | C |
| 1940 | 6589 | 124% | AN | 4047 | 112% | AN | W/AN |
| 1941 | 7932 | 150% | W | 5515 | 153% | W | W |
| 1942 | 7382 | 139% | W | 5282 | 147% | W | W |
| 1943 | 7266 | 137% | W | 4273 | 119% | AN | W |
| 1944 | 3919 | 74% | BN | 2973 | 83% | BN | D |
| 1945 | 6599 | 125% | AN | 4371 | 121% | AN | BN |
| 1946 | 5729 | 108% | AN | 3645 | 101% | AN | AN |
| 1947 | 3418 | 64% | D | 2116 | 59% | D | D |
| 1948 | 4210 | 79% | BN | 3583 | 100% | BN | AN |

TABLE 3.1.3.4-2 (continued)
 SAN JOAQUIN RIVER BASIN FOUR RIVER INDEX AND HYDROLOGIC CLASSIFICATIONS *

| WATER YEAR | | | | APRIL THROUGH JULY | | | D-1485 ** |
|------------|-------------------------|---------------------|---------------------------|-------------------------|---------------------|---------------------------|-----------------------|
| WATER YEAR | UNIMPAIRED RUNOFF (TAF) | PERCENT OF LOG MEAN | WATER YEAR CLASSIFICATION | UNIMPAIRED RUNOFF (TAF) | PERCENT OF LOG MEAN | APRIL-JULY CLASSIFICATION | D-1485 CLASSIFICATION |
| 1949 | 3793 | 72% | BN | 3113 | 86% | BN | D |
| 1950 | 4652 | 88% | BN | 3571 | 99% | BN | BN |
| 1951 | 7251 | 137% | W | 2829 | 79% | BN | W/SS |
| 1952 | 9305 | 176% | W | 6834 | 190% | W | W |
| 1953 | 4354 | 82% | BN | 3184 | 88% | BN | W |
| 1954 | 4300 | 81% | BN | 3161 | 88% | BN | AN |
| 1955 | 3500 | 66% | O | 2666 | 74% | BN | D |
| 1956 | 9669 | 182% | W | 5291 | 147% | W | W |
| 1957 | 4288 | 81% | BN | 3187 | 89% | BN | BN |
| 1958 | 8356 | 158% | W | 6396 | 178% | W | W |
| 1959 | 2980 | 56% | C | 1853 | 51% | C | D |
| 1960 | 2958 | 56% | C | 2072 | 58% | C | BN/SS |
| 1961 | 2095 | 40% | C | 1497 | 42% | C | D |
| 1962 | 5612 | 106% | AN | 4245 | 118% | AN | BN |
| 1963 | 6237 | 118% | AN | 4369 | 121% | AN | W |
| 1964 | 3143 | 59% | D | 2144 | 60% | D | D |
| 1965 | 8120 | 153% | W | 4549 | 126% | W | W |
| 1966 | 3978 | 75% | BN | 2422 | 67% | D | BN/SS |
| 1967 | 9985 | 188% | W | 7095 | 197% | W | W |
| 1968 | 2935 | 55% | C | 1850 | 51% | C | BN/SS |
| 1969 | 12292 | 232% | W | 8140 | 226% | W | W |
| 1970 | 5613 | 106% | AN | 2956 | 82% | BN | W/SS |
| 1971 | 4907 | 93% | BN | 3228 | 90% | BN | W |
| 1972 | 3577 | 67% | D | 2209 | 61% | D | BN/SS |
| 1973 | 6475 | 122% | AN | 4487 | 125% | AN | W |
| 1974 | 7127 | 134% | W | 4537 | 126% | W | W |
| 1975 | 6156 | 116% | AN | 4647 | 129% | W | AN |
| 1976 | 1942 | 37% | C | 1050 | 29% | C | C |
| 1977 | 1016 | 19% | C | 782 | 22% | C | C |
| 1978 | 9425 | 178% | W | 6363 | 177% | W | W |
| 1979 | 5982 | 113% | AN | 3991 | 111% | AN | D |
| 1980 | 9453 | 178% | W | 5389 | 150% | W | W |
| 1981 | 3089 | 58% | D | 2203 | 61% | D | D |
| 1982 | 11259 | 212% | W | 6951 | 193% | W | W |
| 1983 | 14828 | 280% | W | 8625 | 240% | W | W |
| 1984 | 6843 | 129% | W | 3479 | 97% | BN | W/SS |
| 1985 | 3540 | 67% | D | 2379 | 66% | D | D |
| 1986 | 9293 | 175% | W | 4584 | 127% | W | W/SS |
| 1987 | 2029 | 38% | C | 1453 | 40% | C | C |

* W - Wet; AN - Above Normal; BN - Below Normal; D - Dry; C - Critically Dry; SS - Subnormal Snowmelt

** In some cases a year will have a dual classification - one classification for fish and wildlife standards and the next wetter classification for agricultural and municipal and industrial standards

This table is significant for historical reasons

TABLE 3.1.3.4-3
 DECISION 1485 WATER YEAR CLASSIFICATION
 FOR THE SACRAMENTO RIVER BASIN:
 NUMBER AND PERCENTAGE OF OCCURENCES

| <u>Classification</u> | <u>Hydrologic Period</u> | | <u>Percentage</u> | |
|-----------------------|----------------------------------|--------------------------------|---------------------|----------------------|
| | <u>No. of Years</u> | <u>Frequency of Occurrence</u> | <u>No. of Years</u> | <u>of Occurrence</u> |
| | <u>1922 to 1971^{1/}</u> | | <u>1906 to 1987</u> | |
| Wet | 16 | 32% | 33 | 40% |
| Above Normal | 9 | 18% | 11 | 13% |
| Below Normal | 9 | 18% | 13 | 16% |
| Dry | 10 | 20% | 15 | 18% |
| Critical | 6 | 12% | 10 | 12% |
| TOTAL | 50 | 100% | 82 | 100% |

^{1/} Time period used in The Delta Plan to develop the original water year classification system.

Likewise, when the entire water year classification (1906 to 1987) is compared with the April through July classification for both the Sacramento and San Joaquin River basins, small changes in the percentage of occurrence also result (Tables 3.1.3.4-4 & -5). A comparison of the D-1485 classification with the April through July classification for the Sacramento River Basin over the 1906-87 period gives a difference in 35 years. In 18 of the 82 years, however, the April to July classification is wetter and in 17 years the classification is drier--a net real difference of one.

Finally, comparing the April to July classification for the San Joaquin River with the same classification for the Sacramento River, there is a difference in 31 years. In 15 of the 82 years, the San Joaquin classification is wetter, in 16 years drier--again, a net real difference of one. Where differences do exist between classifications and between basins, they are mainly due to the timing and magnitude of runoff as well as the boundaries of water year types.

Finally, when the classifications proposed in the Plan are compared with those in the Delta Plan, the total numbers of years in the extreme classifications, wet and critical, are reduced while the other, middle ranges are increased for both Basins (Table 3.1.3.4-6).

Why aren't these the same?

TABLE 3.1.3.4-4
WATER YEAR AND APRIL THROUGH JULY CLASSIFICATION:
FREQUENCIES OF OCCURRENCE
FOR THE SACRAMENTO RIVER BASIN

Probably because it's not the D-1485 scheme

| <u>Classification System</u> | | | | |
|------------------------------|---------------------|--------------------------------|-----------------------------------|--------------------------------|
| <u>Water Year</u> | | | <u>April-July</u> | |
| <u>Classification</u> | <u>No. of Years</u> | <u>Frequency of Occurrence</u> | <u>No. of Years</u> ^{1/} | <u>Frequency of Occurrence</u> |
| Wet | 30 | 37% | 28 | 34% |
| Above Normal | 10 | 12% | 10 | 12% |
| Below Normal | 15 | 18% | 24 | 29% |
| Dry | 17 | 21% | 12 | 15% |
| Critical | 10 | 12% | 8 | 10% |
| TOTAL | 82 | 100% | 82 | 100% |

1/ Year following critical year classification not included.

TABLE 3.1.3.4-5
WATER YEAR AND APRIL THROUGH JULY CLASSIFICATION:
FREQUENCIES OF OCCURRENCE
FOR THE SAN JOAQUIN RIVER BASIN

| <u>Classification System</u> | | | | |
|------------------------------|---------------------|--------------------------------|---------------------|--------------------------------|
| <u>Water Year</u> | | | <u>April-July</u> | |
| <u>Classification</u> | <u>No. of Years</u> | <u>Frequency of Occurrence</u> | <u>No. of Years</u> | <u>Frequency of Occurrence</u> |
| Wet | 25 | 31% | 27 | 33% |
| Above Normal | 20 | 24% | 15 | 18% |
| Below Normal | 13 | 16% | 19 | 23% |
| Dry | 10 | 12% | 10 | 12% |
| Critical | 14 | 17% | 11 | 14% |
| TOTAL | 82 | 100% | 82 | 100% |

3.2 Sacramento River Basin

3.2.1 Physical Description

The Sacramento River Basin, Basin 5A in Figure 3.1-2, includes the westerly drainage of the Sierra Nevada and the Cascade ranges, the easterly drainage of the Coast Range, and the valley floor. The Basin covers about 26,500 square miles (16,960,000 acres) and extends from the Goose Lake Basin at the Oregon border to the American River Basin (RWQCB 5, 1975). The Basin includes the watersheds of the following major tributaries: McCloud, Pit, Feather, Yuba, Bear, and American rivers, and Cottonwood, Stony, Cache, and Putah creeks. In years of normal runoff, the Sacramento River Basin contributes about 70 percent of the total runoff to the Estuary (SWRCB, 3, 3).

TABLE 3.1.3.4-6

PROPOSED AND 1978 WQCP
 HYDROLOGIC CLASSIFICATIONS
 NUMBER AND FREQUENCIES OF OCCURRENCE
 (1906 THROUGH 1987)

SACRAMENTO RIVER BASIN

| PROPOSED SALINITY CONTROL PLAN | | | 1978 WATER QUALITY CONTROL PLAN * | | |
|--------------------------------|--------------|-------------------------|-----------------------------------|--------------|-------------------------|
| April-July Classification | No. of Years | Frequency of Occurrence | Water Year Classification | No. of Years | Frequency of Occurrence |
| Wet | 28 | 34% | Wet | 33 | 40% |
| Above Normal | 10 | 12% | Above Normal | 11 | 13% |
| Below Normal | 24 | 29% | Below Normal | 13 | 16% |
| Dry | 12 | 15% | Dry | 15 | 18% |
| Critical | 8 | 10% | Critical | 10 | 12% |
| TOTAL | 82 | 100% | TOTAL | 82 | 100% |

SAN JOAQUIN RIVER BASIN

| PROPOSED SALINITY CONTROL PLAN | | | 1978 WATER QUALITY CONTROL PLAN * | | |
|--------------------------------|--------------|-------------------------|-----------------------------------|--------------|-------------------------|
| April-July Classification | No. of Years | Frequency of Occurrence | Water Year Classification | No. of Years | Frequency of Occurrence |
| Wet | 27 | 33% | Wet | | |
| Above Normal | 15 | 18% | Above Normal | | |
| Below Normal | 19 | 23% | Below Normal | | SAME AS ABOVE |
| Dry | 10 | 12% | Dry | | |
| Critical | 11 | 14% | Critical | | |
| TOTAL | 82 | 100% | TOTAL | | |

No sees along w/ wide perception of in California's climate.

* NOT INCLUDING SUB-NORMAL SNOWMELT CLASSIFICATION

The Sacramento Valley floor ranges from 30 to 45 miles wide in the central and southern parts, but narrows to five miles at its northern end; it slopes southward from about 300 feet above sea level at the north end near Red Bluff to sea level at Suisun Bay. The crestline of the Sierra Nevada generally ranges from 8,000 to 10,000 feet, while the crestline of the Coast Range extends from 2,000 to 8,000 feet. Due to the large snowpack at higher elevations in the Basin, the greatest volume of streamflow above the reservoirs occurs during snowmelt in the spring and early summer.

3.2.2 Hydrology

The Sacramento River Basin receives water transfers from other basins via the following projects:

Trinity River, Sly Park, Little Truckee Ditch, and Echo Lake Conduit.

how much from each?

The Basin exports water to other basins via the following projects:

Putah South Canal, Folsom South Canal, Tule Lake Diversion, North Fork Ditch, and Folsom Lake Diversion.

These and the amounts of other interbasin transfers are shown in Figure 3.2.2-1 (DWR, 19). The basin boundaries in this figure differ somewhat from the boundaries defined in this Plan; however, it provides a good illustration of the magnitude of interbasin water transfers from the Sacramento River Basin to other areas in California.

3.2.3 Unimpaired Flow Conditions

The Sacramento River Basin inflow to the Delta comes from four major river systems—the Sacramento, Feather, Yuba, and American. The unimpaired flows from these river systems, often referred to as the Sacramento River Basin Four Rivers Index, represent approximately 47, 25, 13, and 15 percent, respectively, of the total flow from the Sacramento River Basin that make up this index. Figure 3.2.3-1 shows the average unimpaired and measured flows over the period of 1922 to 1978 ('1990 level' is the estimated flow for any year given current, or 1990, storage capacities, diversions and exports).

3.2.4 Current Flow Conditions

Delta inflow from the Sacramento River Basin comes from two major sources, the Sacramento River near Sacramento and the Yolo Bypass just west of Sacramento. The current annual flows, i.e., those estimated by DWR's 1990 level operations study, in the Sacramento River near Sacramento for 1922 through 1987 are also shown in Figure 3.2.3-1. In this time period, current flows are expected to decrease below unimpaired flows in wetter years due to upstream diversions and reservoir storage. Dry and critical year flows remain about the same principally due to river flow requirements needed to meet water quality objectives and export demands (Table 3.2.4-1).

FIGURE 3.2.2-1 Interbasin water transfers for a 1980 level of development and the annual amounts in AF/YR (from: DWR, 19)

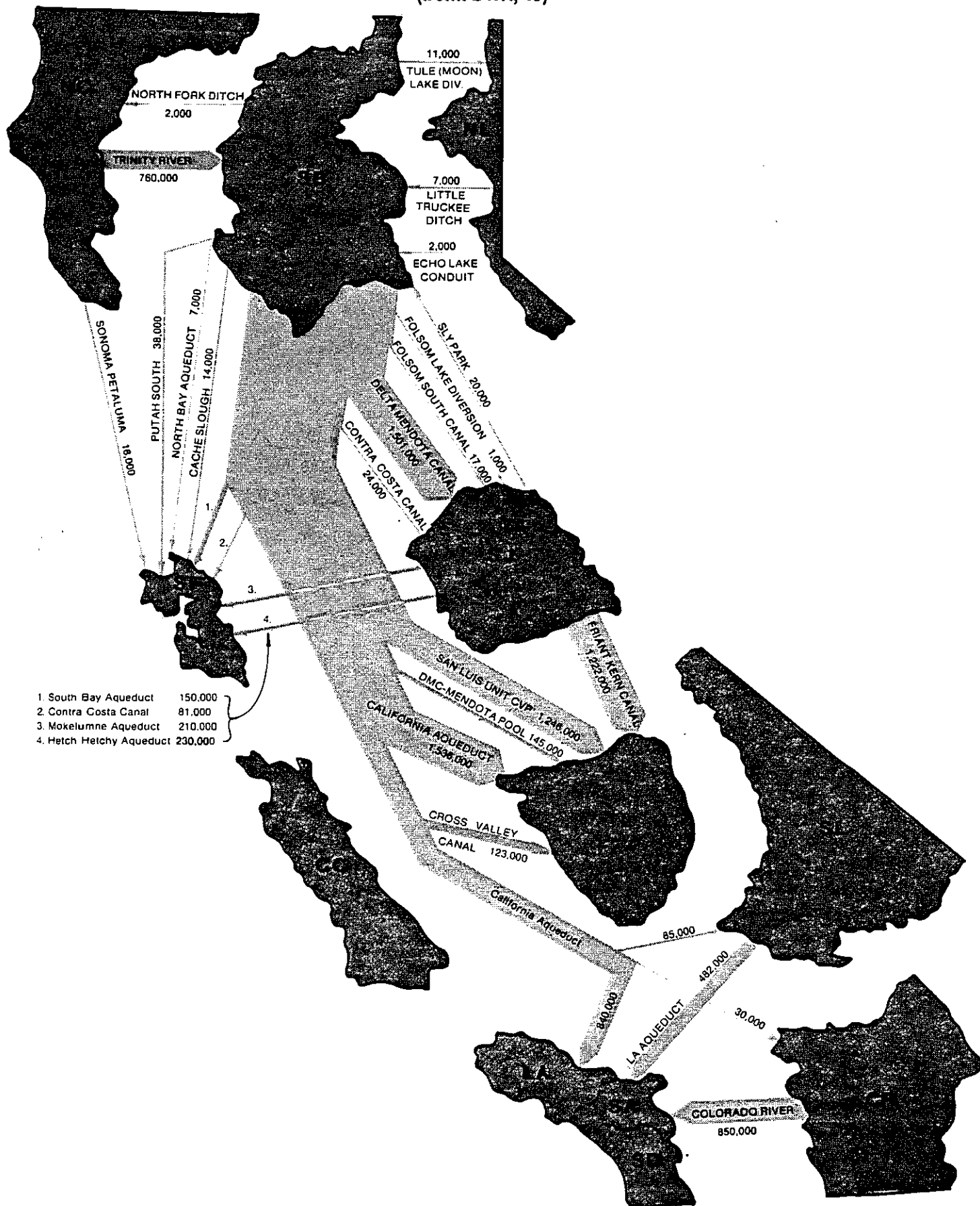
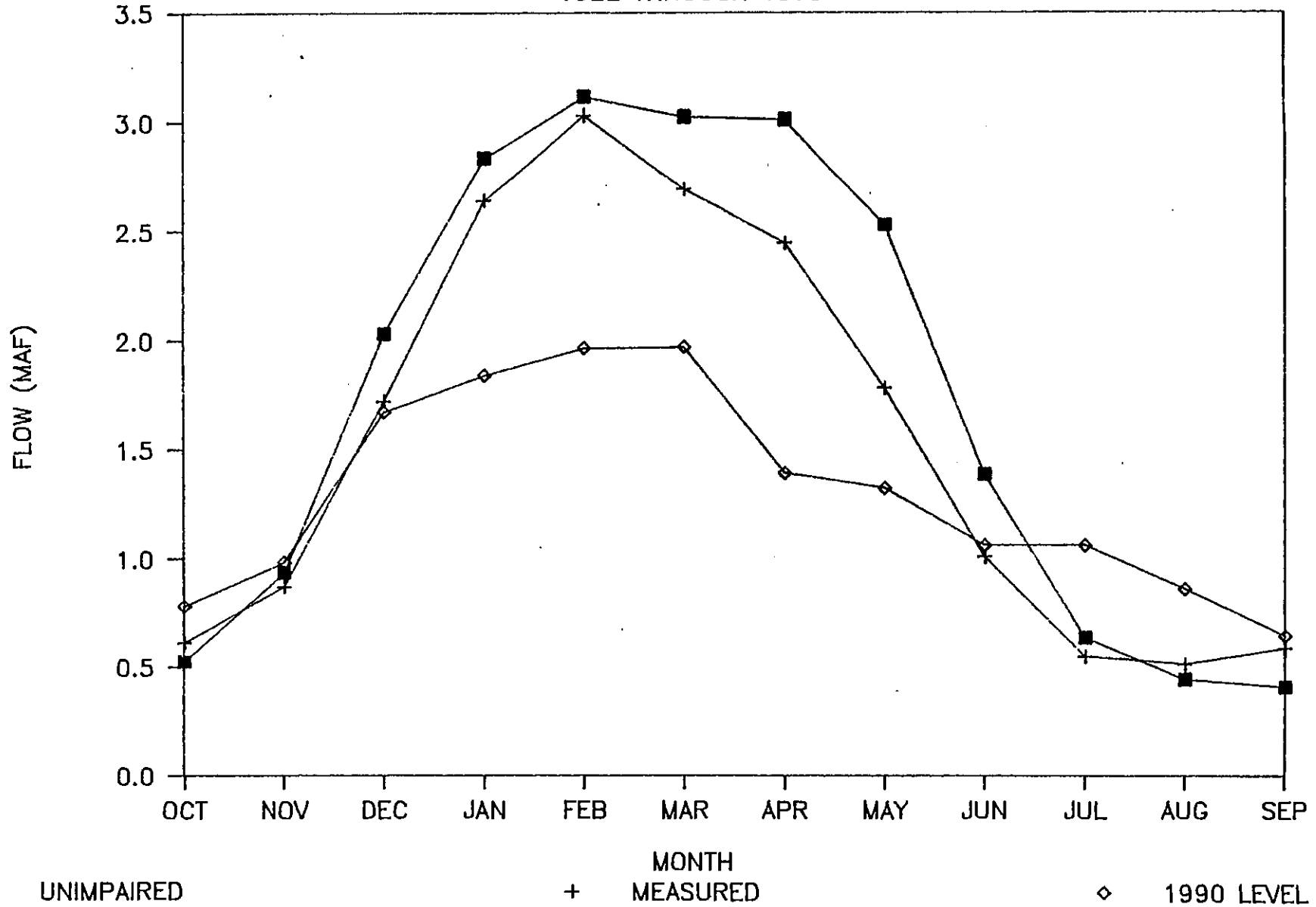

FIGURE 3.2.3-1

SACRAMENTO VALLEY AVERAGE MONTHLY FLOW

1922 THROUGH 1978



3-21

TABLE 3.2.4-1
SACRAMENTO RIVER BASIN:
UNIMPAIRED FLOW AND CURRENT FLOW CONDITIONS
BY WATER YEAR TYPE^{1/}

| Water Year Type ^{2/} | Unimpaired Flow (TAF) ^{3/} | | Current Flow ^{4/} (TAF) (The Delta Plan Requirements) | |
|-------------------------------|-------------------------------------|--------|---|--------|
| | Low | High | Low | High |
| Wet | 24,456 | 40,639 | 19,711 | 36,003 |
| Above Normal | 18,284 | 23,673 | 12,682 | 20,698 |
| Below Normal | 15,063 | 18,061 | 8,923 | 15,768 |
| Dry | 12,014 | 14,231 | 10,597 | 14,089 |
| Critical | 5,557 | 10,103 | 7,092 | 10,737 |

1/ Using 1922 through 1978 hydrology.

2/ Using the wetter classification in dual classification years.

3/ Thousands of acre-feet.

4/ From DWR 1990 Level-of-Development Study.

During high flow periods (greater than 30,000 cfs), the Sacramento River overflows into the Yolo Bypass.

3.3 CENTRAL SIERRA BASIN

3.3.1 Physical Description

Basin 5B in Figure 3.1-2 is referred to as the Central Sierra Basin (SWRCB,3,4). This Basin includes the Delta and the watersheds of the Cosumnes, Mokelumne, and Calaveras rivers. Excluding the Delta, this Basin encompasses about 3,800 square miles (2,432,000 acres) of valley, foothills, and Sierra Nevada. In years of normal runoff, Basin 5B contributes about five percent of the total runoff to the Estuary (SWRCB,3,3).

3.3.2 Hydrology

The Central Sierra Basin inflow to the Delta comes from two river systems, the Mokelumne and Cosumnes, sometimes called the "Eastside Streams." The Basin also receives water from the Sacramento River Basin via the Folsom South Canal and the Folsom Lake Diversion. Water is exported from the Central Sierra Basin via the following projects:

Mokelumne Aqueduct, South Bay Aqueduct^{1/}, and Sly Park.

^{1/} The South Bay Aqueduct diverts water just outside the legal boundaries of the Delta.

3.3.3 Unimpaired Flow Conditions

The Central Sierra Basin contributes about five percent of the average annual unimpaired inflow to the Delta. When unimpaired flows are reduced to current flow conditions, the percentage of the Central Sierra Basin's inflow to the Estuary remains five percent (see 3.3.4).

3.3.4 Current Flow Conditions

As of 1987, about 242,000 acre-feet of water or about one-third of the average annual Mokelumne River flow were diverted into the Mokelumne Aqueduct for use in the east San Francisco Bay area (EBMUD, 1,9). Table 3.3.4-1 compares the amounts of water available in the Central Sierra Basin under unimpaired and current flow conditions.

The Delta Plan does not contain any flow or salinity standards at the Delta inflow points of the Central Sierra Basin.

TABLE 3.3.4-1
CENTRAL SIERRA BASIN:
UNIMPAIRED FLOW AND CURRENT FLOW CONDITIONS
BY WATER YEAR TYPE^{1/}

| Water Year Type ^{2/} | Unimpaired Flow (TAF) ^{3/} | | Current Flow ^{4/} | |
|-------------------------------|-------------------------------------|-------|----------------------------|-------|
| | Low | High | Low | High |
| Wet | 1,176 | 3,329 | 669 | 2,534 |
| Above Normal | 954 | 2,343 | 358 | 1,377 |
| Below Normal | 722 | 1,940 | 319 | 1,092 |
| Dry | 361 | 1,030 | 240 | 505 |
| Critical | 162 | 593 | 163 | 366 |

^{1/} Using 1922 through 1978 hydrology. Individual water years measured as percentages of the Sacramento Basin's Four River Index have been used, resulting in some overlap of flow amounts for different water year types.

^{2/} Using the wetter classification in dual classification years.

^{3/} Thousands of acre-feet.

^{4/} From DWR 1990 Level-of-Development Operation Study; this Basin has no D-1485 requirements.

3.4 San Joaquin River Basin

3.4.1 Physical Description

The San Joaquin River Basin, Basin 5C in Figure 3.1-2, encompasses over 11,000 square miles (7,040,000 acres) between the crest of the Sierra Nevada Range and the crest of the Coast Range, and stretches southward from the Delta to the drainage divide between the San Joaquin and Kings rivers. The valley floor in the Basin

measures about 50 miles wide by 100 miles long, and slopes from an elevation of about 250 feet at the southern end to near sea level at the northern end (RWQCB 5, 1975). In years of normal runoff, the San Joaquin River Basin now contributes about 15 percent of the total measured runoff to the Estuary (SWRCB,3,3).

The Kings River historically flowed into Fresno Slough and into the San Joaquin River. Due to upstream controls and diversions, this occurs now about once every three years (DWR,26,33). Due to this discontinuity, the Kings River is now considered to be part of the Tulare Lake Basin, Basin 5D, and not part of the San Joaquin River Basin.

3.4.2 Hydrology

The major tributaries in Basin 5C are the San Joaquin, Merced, Tuolumne, and Stanislaus rivers which originate in the Sierra Nevada. Peak streamflows above the reservoirs generally occur later in spring than the Sacramento Basin because the San Joaquin Basin mountain ranges are generally higher than those in the Sacramento Basin. Smaller tributaries, consisting of runoff from the Coast Range and/or agricultural drainage, include the following:

Salt and Mud sloughs, and Panoche, Little Panoche, Los Banos, Orestimba, and Del Puerto creeks.

Water is imported into the San Joaquin River Basin from the Delta via the Delta-Mendota Canal (DMC) of the CVP. Water is exported from the Basin via the following projects (see Figure 3.2.2-1):

Friant-Kern Canal (CVP), Hetch Hetchy Aqueduct, and San Felipe Unit (CVP).

About 77,000 acres in the San Joaquin River Basin have subsurface agricultural drainage systems which discharge to the San Joaquin River, primarily via Mud and Salt sloughs (EDF,11,I-1). During the irrigation season and occasionally following the flushing of agricultural drainage water from duck clubs in January and February, agricultural drainage makes up a significant portion of San Joaquin River flows and constituent loads (EDF,11,V-36--V-44,V-46&V-47). The San Joaquin River contains considerably higher concentrations of several constituents (including nitrates, selenium, arsenic, nickel and manganese) than the Sacramento River (AHI,302,219,231).

3.4.3 Unimpaired Flow Conditions

The unimpaired and measured annual flow of the four major rivers in the San Joaquin River Basin are shown in Figure 3.4.3-1 for WYs 1922 to 1978.

The completion of the Friant and Delta-Mendota Canal units of the CVP around 1950 altered the natural state of the San Joaquin River. A comparison of the pre-1950 and the post-1950 unimpaired versus measured flow relationship is shown in Figure 3.4.3-2 (EDF,11,II-30). The two regression lines in the figure are significantly different, indicating that the total amount of flow measured at Vernalis (the entry point of the San Joaquin River to the Delta) has decreased since 1950 (see 3.4.4).

FIGURE 3.4.3-1

SAN JOAQUIN VALLEY AVERAGE MONTHLY FLOW

1922 THROUGH 1978

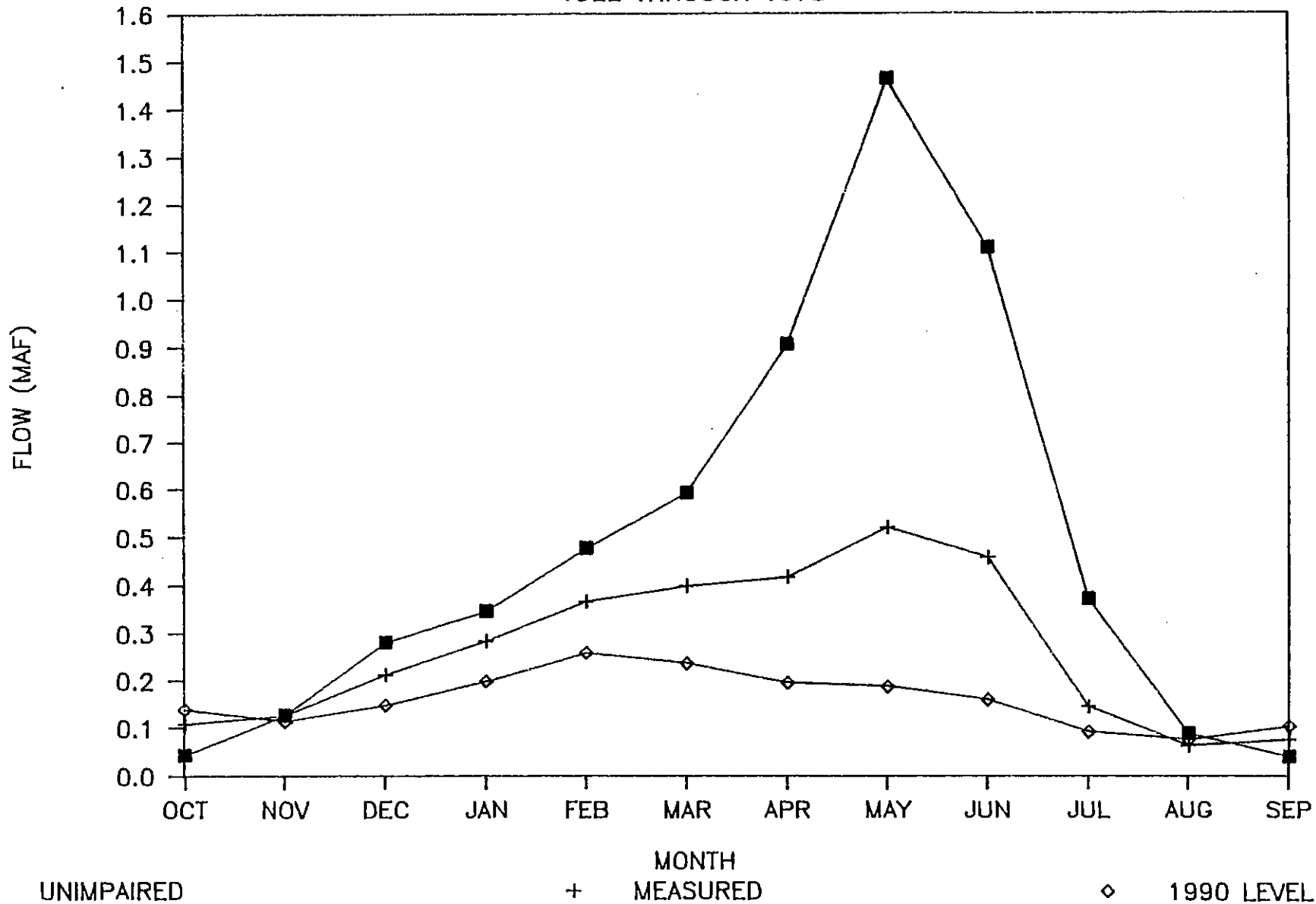

3-25

FIGURE 3.4.3-2 Unimpaired flows versus measured flows for the San Joaquin Basin

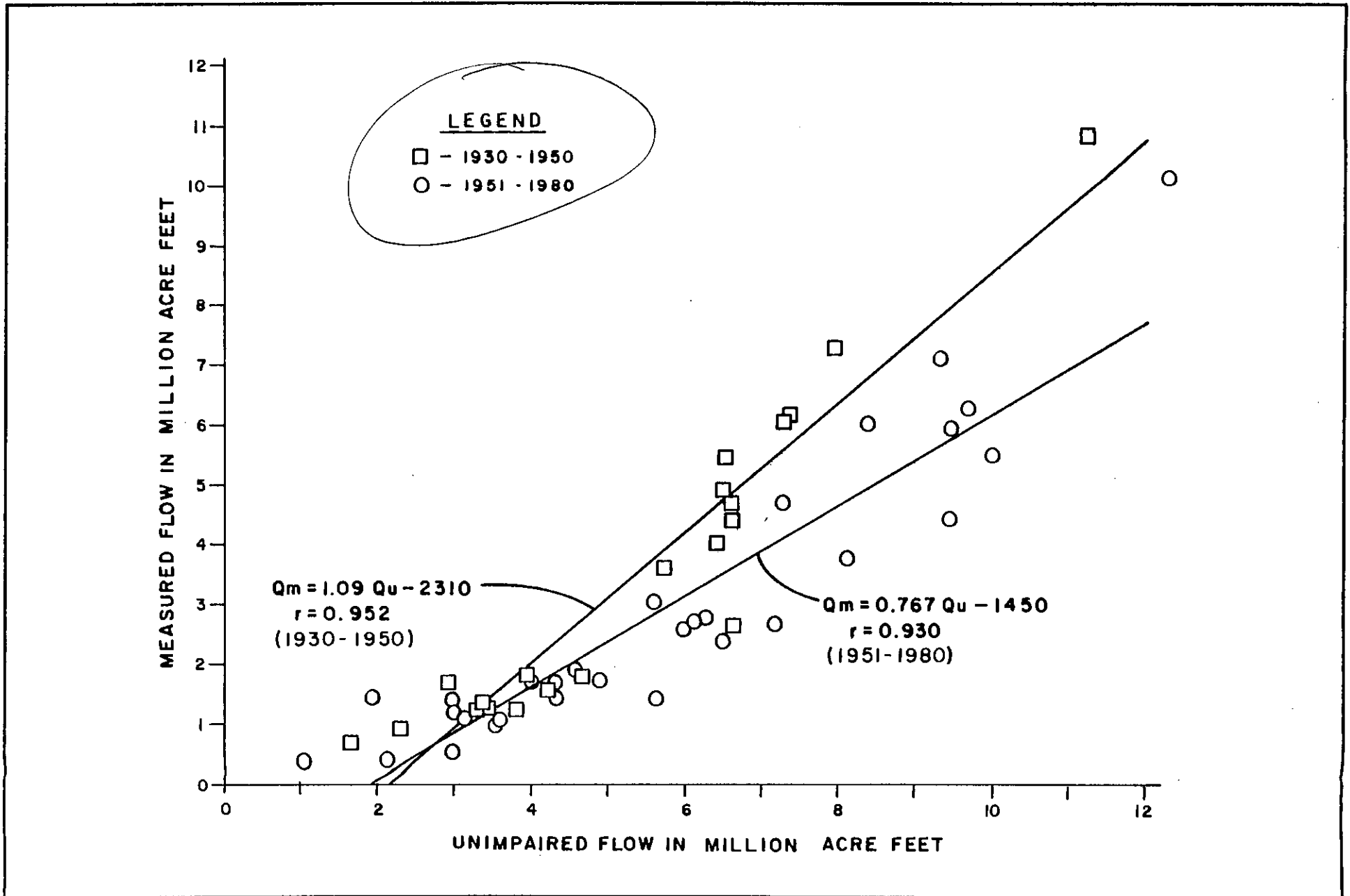

3.4.4 Current Flow Conditions

The annual measured flows in the San Joaquin River near Vernalis for WYs 1921 to 85 are also plotted in Figure 3.4.3-1 for comparison (flow data are not available for the 1906 to 20 and 1986 to 87 time periods). With the exception of the extremely wet WY 1983, the annual measured flows are less than the unimpaired flows^{1/}.

irrigation { The main reason for the differences between annual unimpaired and measured flows is the consumptive water use by valley agriculture during the irrigation season, generally from April through September. Reservoirs on the four major rivers in the San Joaquin River Basin have also altered the timing of measured flows in relation to the unimpaired flows above the reservoirs, and have raised flows in September and October above unimpaired levels. }

The current water quality objective set by The Delta Plan for the San Joaquin River Basin is a monthly mean of 500 ppm TDS for the San Joaquin River near Vernalis (RWQCB 5, 1975). For the period of 1975 through 1987, the 500 ppm TDS objective was met in all but two critically dry water years, 1976 and 1977, as well as the beginning of Water Year 1978. However, this 12-year period was dominated by wet years--six wet, two above normal, two dry, and two critical. Table 3.4.4-1 compares the amounts of water available in the San Joaquin River Basin under unimpaired and current flow conditions.

Figure 3.4.4-1, plotting annual salinity as TDS in the San Joaquin River near Vernalis for 1930-80 (Data from Orlob, 1982), shows that salinity concentrations have increased since 1930. The salt load has also increased since 1985, according to Dr. G. T. Orlob's analysis of USBR data measured at Vernalis (Orlob, 1988), probably because of the bypassing of agricultural drainage around the Grassland Water District directly to the San Joaquin River.

3.5 The Delta

3.5.1 Physical Description

The Delta is a roughly triangular area of approximately ~~about~~ 1,150 square miles (738,000 acres) extending from Chipps Island near Pittsburg on the west to Sacramento on the north and to the Vernalis gaging station on the south (see Figure 3.1-1) (California Water Code Section 12220). This area includes those waterways above the confluence of the Sacramento and San Joaquin rivers which are influenced by tidal action, and about 800 square miles (512,000 acres) of agricultural lands which derive their water supply from these waterways. The total surface area of these waterways is over 75 square miles (48,000 acres) with an aggregate navigable length of about 550 miles. Major tributaries to the Delta, besides the Sacramento and San Joaquin rivers, include the Cosumnes, Mokelumne, and Calaveras rivers, Dry Creek, and the Yolo Bypass.

^{1/} In WY 1983, flows from the Tulare Lake Basin contributed over two million acre-feet to the San Joaquin River flows near Vernalis, but were not included in the unimpaired flow of the four major rivers (DWR, 26, 33).

**FIGURE 3.4.4-1 Salinity, Flow and Salt Load in the San Joaquin River
near Vernalis (5 year running Averages)**
(adapted from Orlob, 1982 data)

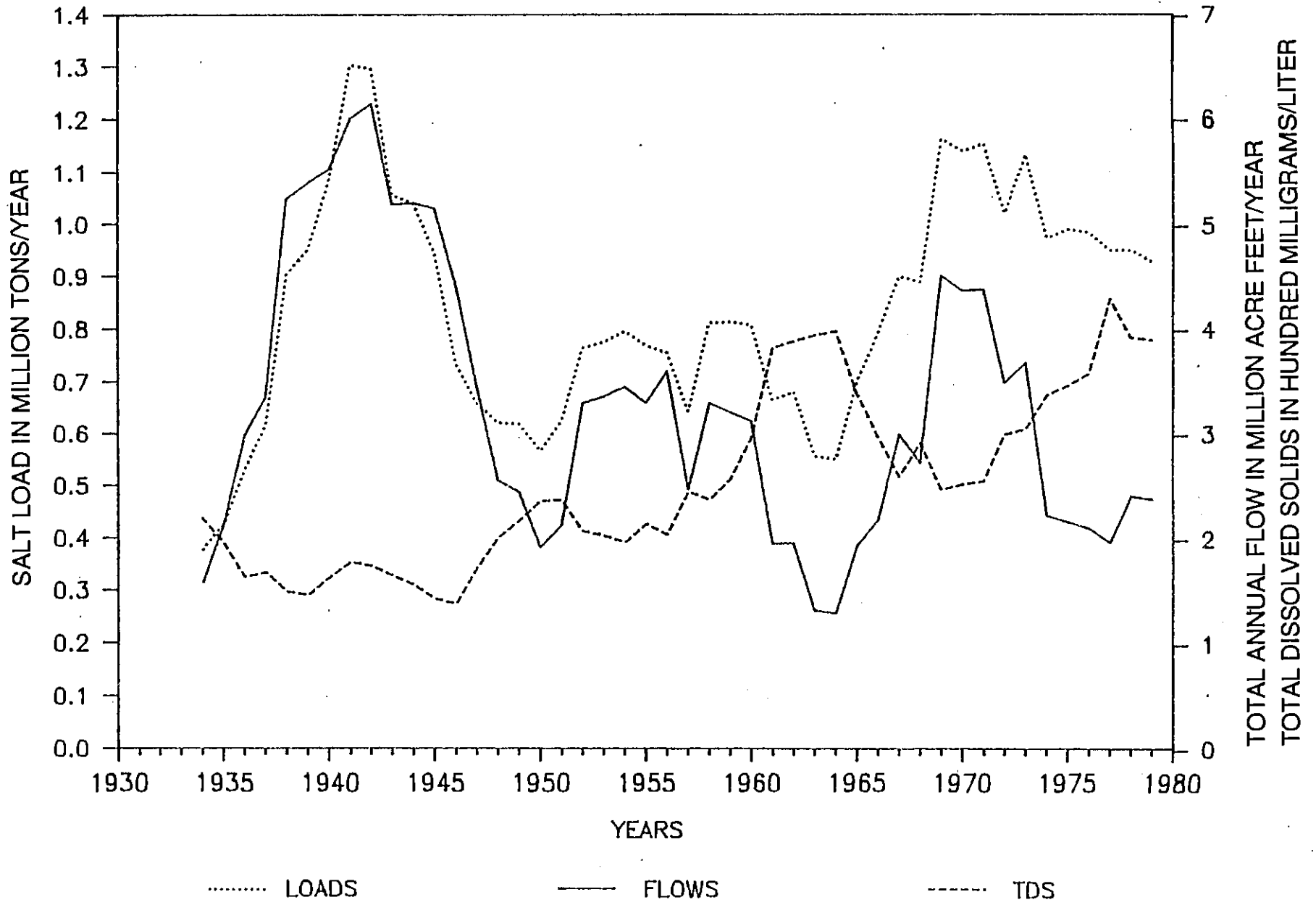

Table 3.4.4-1
 SAN JOAQUIN RIVER BASIN:
 UNIMPAIRED FLOW AND CURRENT FLOW CONDITIONS
 BY WATER YEAR TYPE^{1/}

| Water Year Type | Unimpaired Flow (TAF) ^{2/} | | Current Flow (The Delta Plan Requirements) | |
|-----------------|-------------------------------------|--------|--|-------|
| | Low | High | Low | High |
| Wet | 4,522 | 15,020 | 1,124 | 6,571 |
| Above Normal | 4,339 | 8,703 | 945 | 2,901 |
| Below Normal | 3,017 | 7,530 | 926 | 2,488 |
| Dry | 2,132 | 4,128 | 957 | 1,598 |
| Critical | 1,026 | 3,436 | 850 | 1,596 |

^{1/} Assuming 1922 through 1978 hydrology. Individual water years measured as percentages of the Sacramento Basin's Four River Index (see Chapter 4) have been used, resulting in some overlap of flow amounts for different water year types.

^{2/} Thousands of acre-feet.

Water is exported from the Delta at four major locations (identified by number on Figure 3.1-1):

Tracy Pumping Plant (1), Clifton Court Intake (2), Contra Costa Canal at Pumping Plant No. 1 (3), and the City of Vallejo intake at Cache Slough (4). The North Bay Aqueduct intake at Barker Slough (5) has recently replaced the City of Vallejo's intake (DWR,707,50).

3.5.2 Hydrology

3.5.2.1 Background

In its original condition, the Delta was a vast, flat marsh traversed by an ever changing network of channels and sloughs that divided the area into islands (SWC,262,A2-15). "During the flood season, the Delta became a great inland lake; when the floodwater receded, the network of sloughs and channels reappeared throughout the marsh" (DWR,707,67). In the 1860's reclamation began on low-lying areas, and local landowners undertook cooperative levee construction to allow the lands to be farmed. By the 1920's about 45,000 acres were completely reclaimed and in agricultural production (SWRCB,13,III-4); and "{m}any miles of entirely new channels had been dredged, and farmlands, small communities, highways and utilities were protected--often tenuously--by 1,100 miles of levees, many of them built on peat soils" (DWR,707,67).

The export of water directly from the Delta first took place in 1940 with the completion of the Contra Costa Canal, a unit of the CVP. In 1951, water supplying the Delta-Mendota Canal began to be exported at the CVP's Tracy Pumping Plant (DWR,707,67). In the same year the Delta Cross Channel and control gates were constructed near Walnut Grove to allow a more efficient transfer of water to the Tracy pumps (SWRCB,13,III-6). With the commencement of operation of the State Water Project's (SWP) Harvey O. Banks Pumping Plant in 1967, Delta exports were again increased. By 1975 the combined deliveries of waters exported by both the CVP and SWP totaled 4.8 million acre-feet per year--totals projected to reach 6.6 million acre-feet per year by the year 2000 (USBR,2,27).

3.5.2.2 Water Flow

- Inflow

Freshwater flow into the Delta comes primarily from the Sacramento and San Joaquin rivers, with small additional amounts contributed by the Mokelumne and Cosumnes rivers (SWRCB,13,III-7). Under present conditions, these river systems contributed 85, 10, and 5 percent, respectively, of the average annual Delta inflow during the water years 1922 to 1978 (DWR, 1987, from DWR 1990 'Level of Development Operation Model Output').

- In-channel Flow

Flows in the Delta channels themselves result from a combination of Delta inflows, Delta agricultural use, export diversions, and the counteracting force of the tides from the Pacific Ocean through the San Francisco Bay. Many times when freshwater inflows are low, flows can change direction and move back upstream on incoming tides. The distance of the upstream movement, and the extent of saline intrusion, can vary depending on the quantities of water flowing in and the opposing force of tidal action (SWRCB, 14, II-1). The total flow, however, is normally downstream, out of the Delta (SWRCB, 13, III-11).

- Outflow

The total outflow from the Delta is a combination of unimpaired runoff, Delta channel depletions, exports and upstream developments, which either reduce unimpaired runoff or change its time of occurrence.

Delta outflow is highly seasonal and is characterized by large winter inflows from rainfall runoff generated by Pacific storms, and small, relatively steady inflows during the dry summers from reservoir releases. Delta outflow commonly exceeds 35,000 cfs from December through April, whereas it is usually less than 14,000 cfs from July through October (USGS, 10, 6).

3.5.2.3 Flow Measurement

Tidal movement, Delta channel depletions, and Delta exports (see 3.5.2.4) are not directly measured at present due to the complex effects of tidal fluctuation and flow patterns (SWRCB, 14, IV-7). However, an estimate of net Delta outflow is important for purposes of water quality control and water resource management (SWRCB, 13, III-16). The net Delta outflow at Chipps Island is usually estimated by performing a water balance at the boundary of the Delta, using Chipps Island as the western limit. The water balance involves adding the total Delta inflow and Delta precipitation runoff, then subtracting Delta channel depletions and exports (DWR, 47, 2).

DWR has estimated daily Delta outflow at Chipps Island for water years 1956 through 1985 using the flow accounting model, DAYFLOW. DAYFLOW is also used to estimate interior Delta flow at specified locations. (DWR, 47) Figure 3.5.2.3-1 gives the means and standard deviations of Delta outflows computed by DAYFLOW for water years 1956 through 1985 (USGS, 10, 6).

Another commonly used estimate of Delta outflow, especially for the daily operation of the CVP and SWP, is the Delta Outflow Index (DOI). The DOI is similar to the DAYFLOW Delta outflow but does not include the smaller peripheral streams entering the Delta, such as the Mokelumne and Calaveras rivers, or the flows through the Yolo Bypass. Because of these differences, the DOI is considered to be less accurate than the DAYFLOW Delta outflow estimate (USBR, 111, 16).

FIGURE 3.5.2.3-1
 (FROM USGS EXHIBIT 10, PAGE 6)

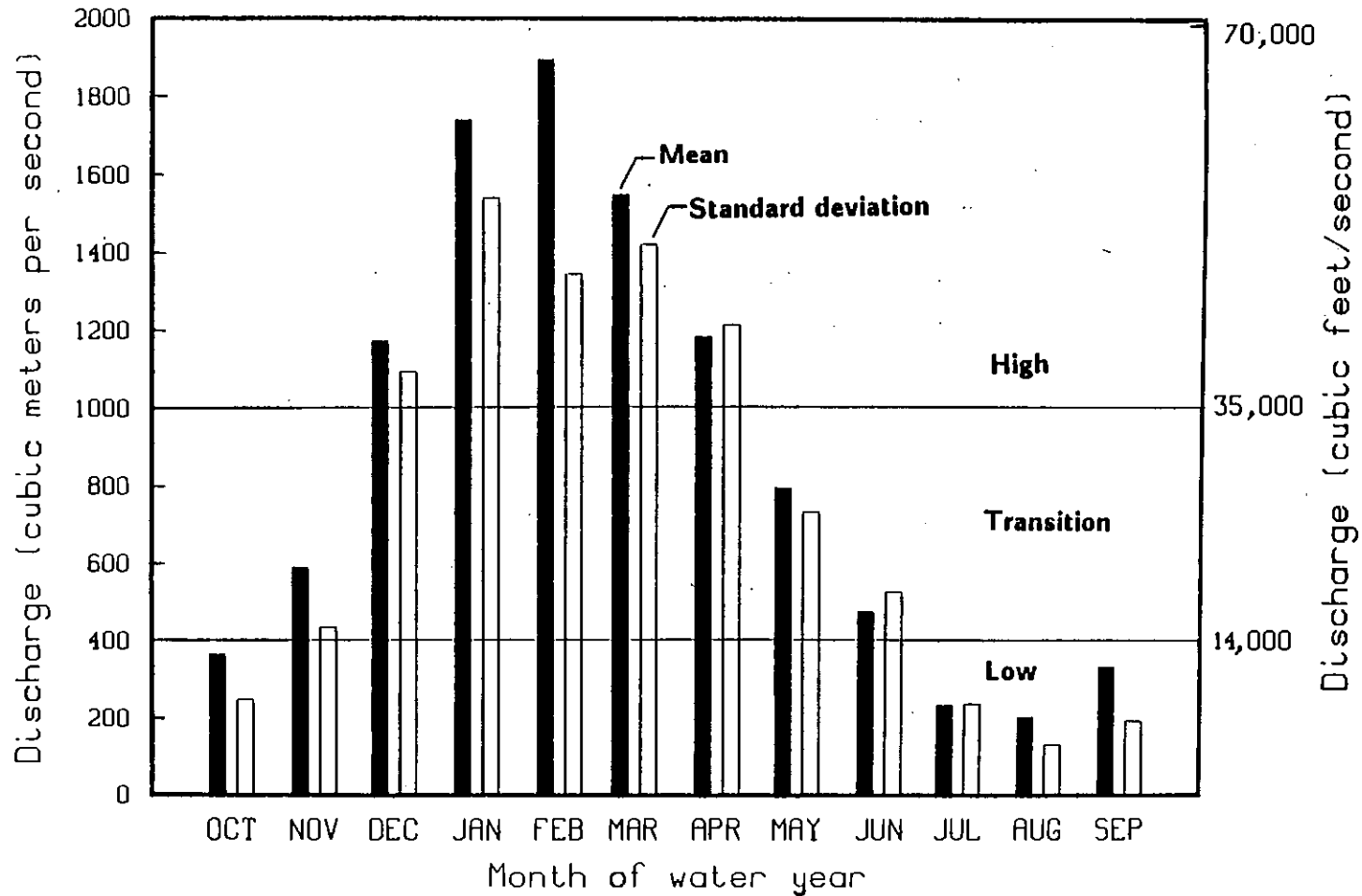

3-32

FIGURE 3.5.2.3-1 --Means and standard deviations of net monthly discharges of the Sacramento-San Joaquin Delta into San Francisco Bay at Chipps Island, 1956-85 from estimates of the State of California (1986). Also shown are arbitrary divisions of the months into high (>1,000 m³/s [35,000 ft³/s]), transition (400-1,000 m³/s [14,000-35,000 ft³/s]), and low (<400 m³/s [14,000 ft³/s]) delta discharges.

3.5.2.4 Channel Depletion, Exports and Reverse Flow

One of the critical factors in determining Delta outflow is Delta channel depletion, that is, "...the diversions of Delta channel waters via pumps, siphons, and subsurface seepage into the Delta uplands and lowlands for consumptive use by agriculture and native plants" (DWR,36,3-4)^{1/}. The Delta channel depletions (not including precipitation) range from approximately 34 TAF in January to 278 TAF in July

(DWR,1988,Operation Study). Currently, over 1,600 diversion locations have been identified within the Delta (T,II,189:17). The location of agricultural irrigation diversion and drainage return points are shown in Figures 3.5.2.4-1 (DWR,49,1) and 3.5.2.4-2 (DWR,64,1).

According to DWR, water supplies for export by the CVP and SWP are obtained from surplus Delta flows, and from upstream reservoir releases during low Delta inflow. Upstream reservoir releases from the Sacramento River Basin enter the Delta via the Sacramento River and then flow by various routes to the pumps in the southern Delta. Some of these releases are drawn to the CVP and SWP pumps through interior Delta channels facilitated in part by the CVP's Delta Cross Channel at Walnut Grove (DWR,707,69).

When export rates are high, the net flow of water can flow in an upstream direction and move toward the export pumps (SWRCB,13,III-II). This is known as reverse flows. During periods of high Delta inflow and high export, there is some reverse flow, but enough water is available from the San Joaquin River, eastern Delta tributaries (Central Sierra Basin) and from water transported out of the Sacramento River via the Delta Cross Channel to meet export demands (Figure 3.5.2.4-3).

When there are high exports, low San Joaquin River inflows and high Delta consumptive uses, however, the normal water path changes, causing a reversal of flows around the lower (western) end of Sherman Island where the Sacramento River and the San Joaquin River meet (SWRCB,13,III-23) (Figure 3.5.2.4-4).

As water travels around Sherman Island, it mixes with saltier ocean water entering as tidal inflow and is drawn upstream into the San Joaquin River and other channels that feed the CVP and SWP pumping plants (DWR,707,69). Figures 3.5.2.4-5 through 3.5.2.4-7 show other typical Delta flow patterns (DWR,51a-e).

^{1/} The consumptive use values used by the USBR and DWR to operate the CVP and SWP were fixed in the Federal-State Memorandum of Agreement dated April 9, 1969. The consumptive use values were based on: (1) a 1955 Delta land use survey; (2) estimates of consumptive use by identified crops; (3) changes in soil moisture; and (4) estimates of leaching requirements (SWRCB,13,III-16). Although the consumptive use values are adjusted seasonally, they are not adjusted between years; error can thereby be introduced into the Delta outflow calculations (USBR,111,16).

FIGURE 3.5.2.4-1

**LOCATION MAP
 IRRIGATION DIVERSION
 POINTS**

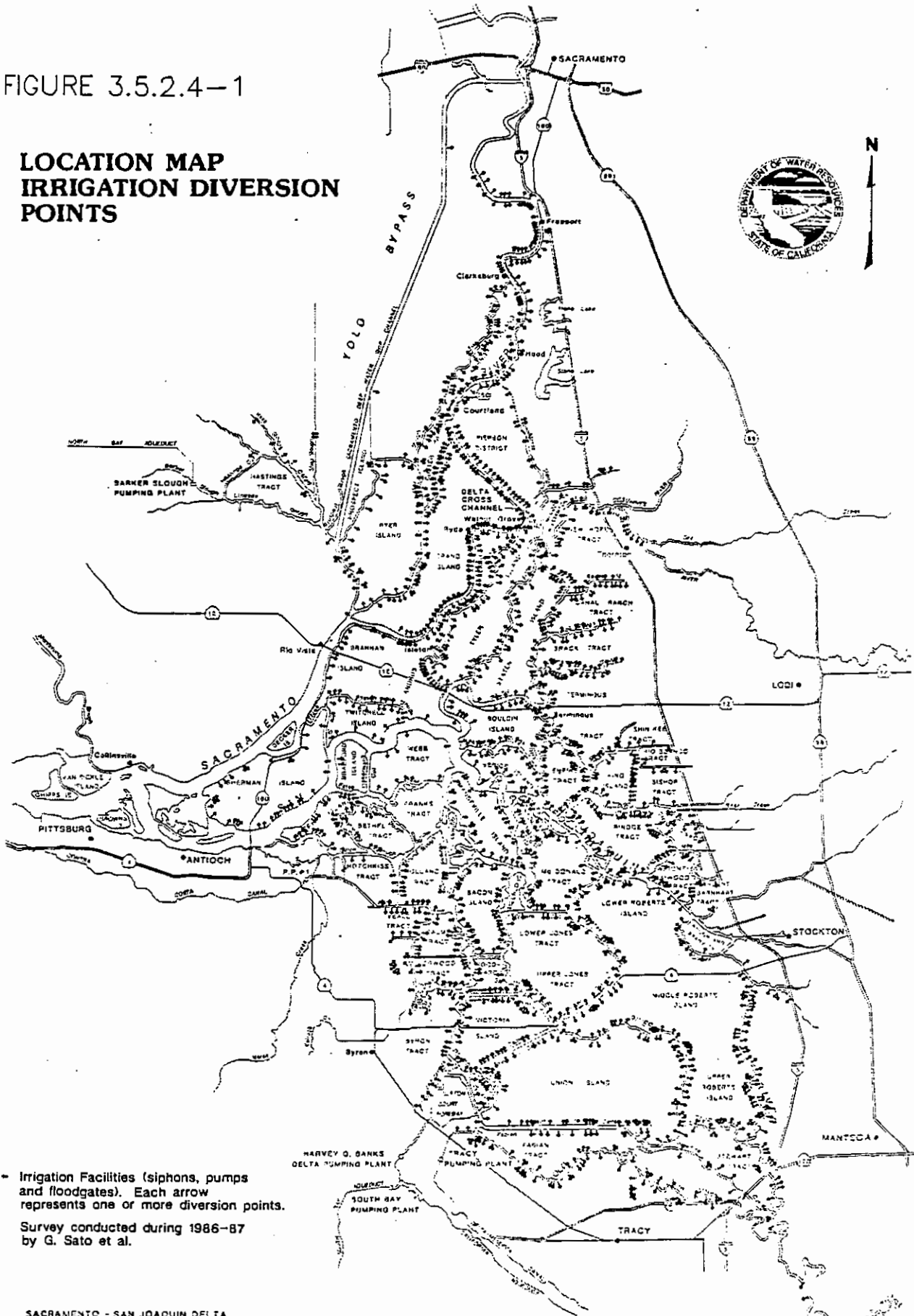

- Irrigation Facilities (siphons, pumps and floodgates). Each arrow represents one or more diversion points.
 Survey conducted during 1986-87 by G. Sato et al.

SACRAMENTO - SAN JOAQUIN DELTA
 SCALE - 4 MILES

FIGURE 3.5.2.4-2

**LOCATION MAP
AGRICULTURAL DRAINAGE
RETURN POINTS**

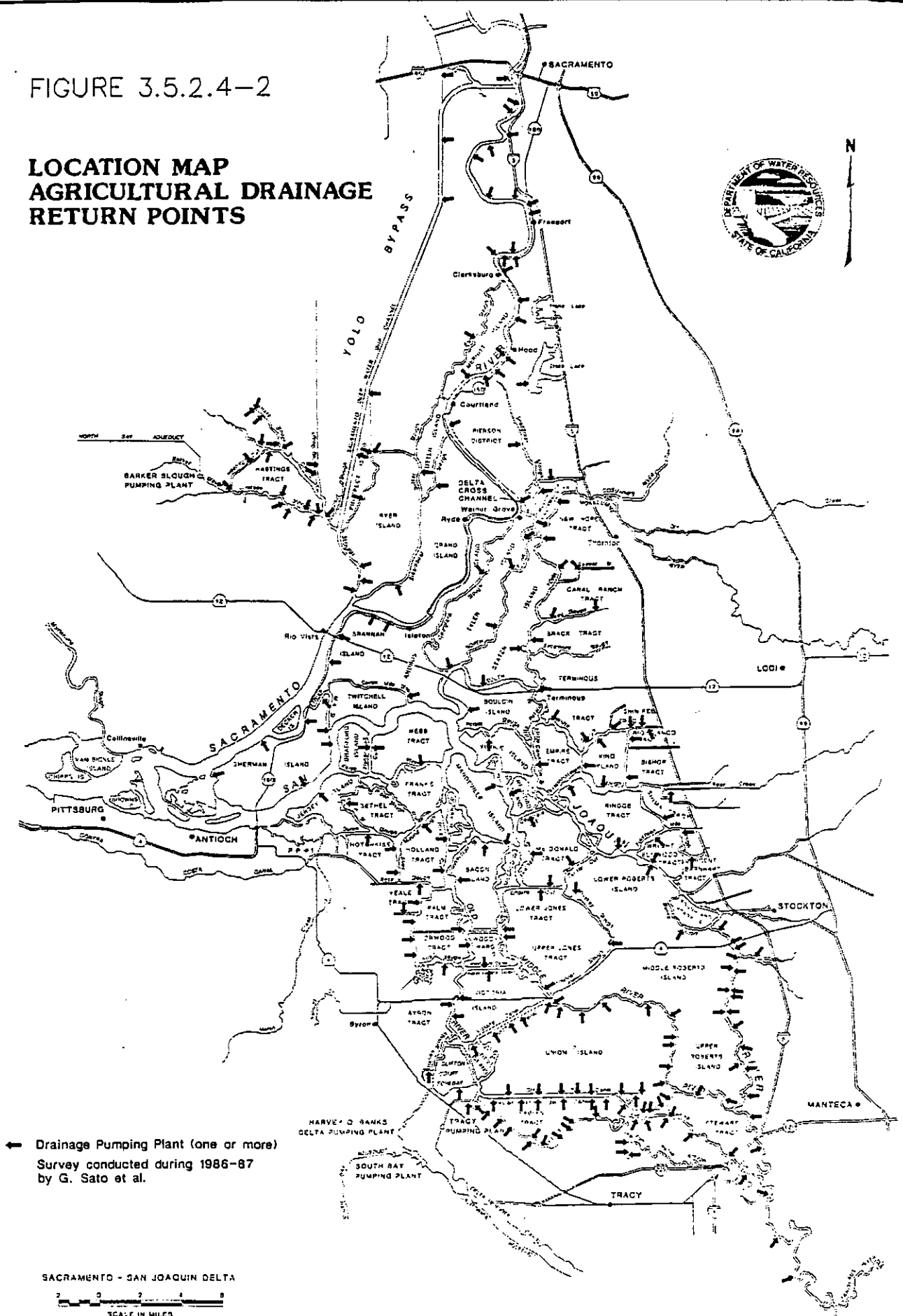

← Drainage Pumping Plant (one or more)
Survey conducted during 1986-87
by G. Sato et al.

SACRAMENTO - SAN JOAQUIN DELTA
SCALE IN MILES

FIGURE 3.5.2.4-3

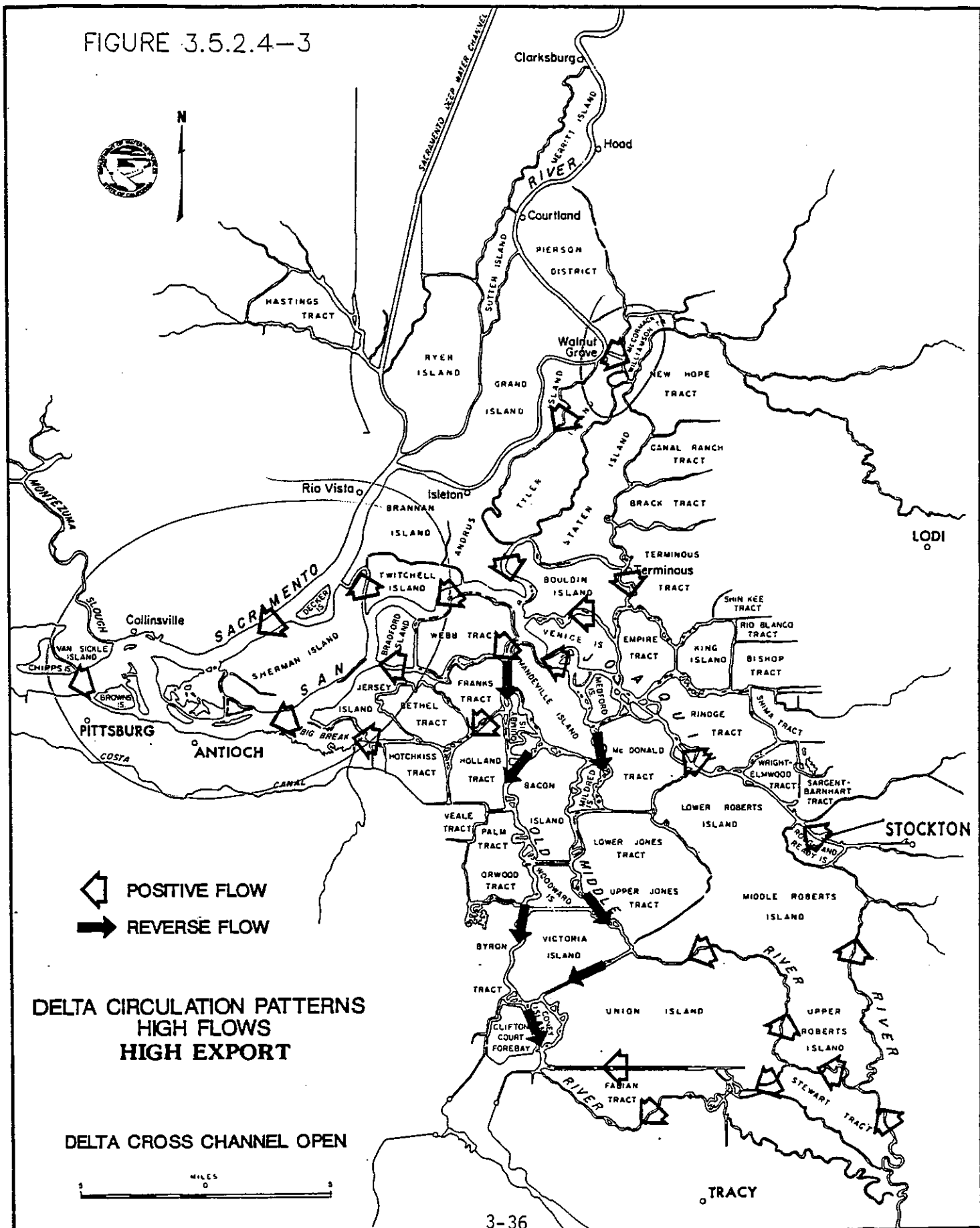

FIGURE 3.5.2.4-4

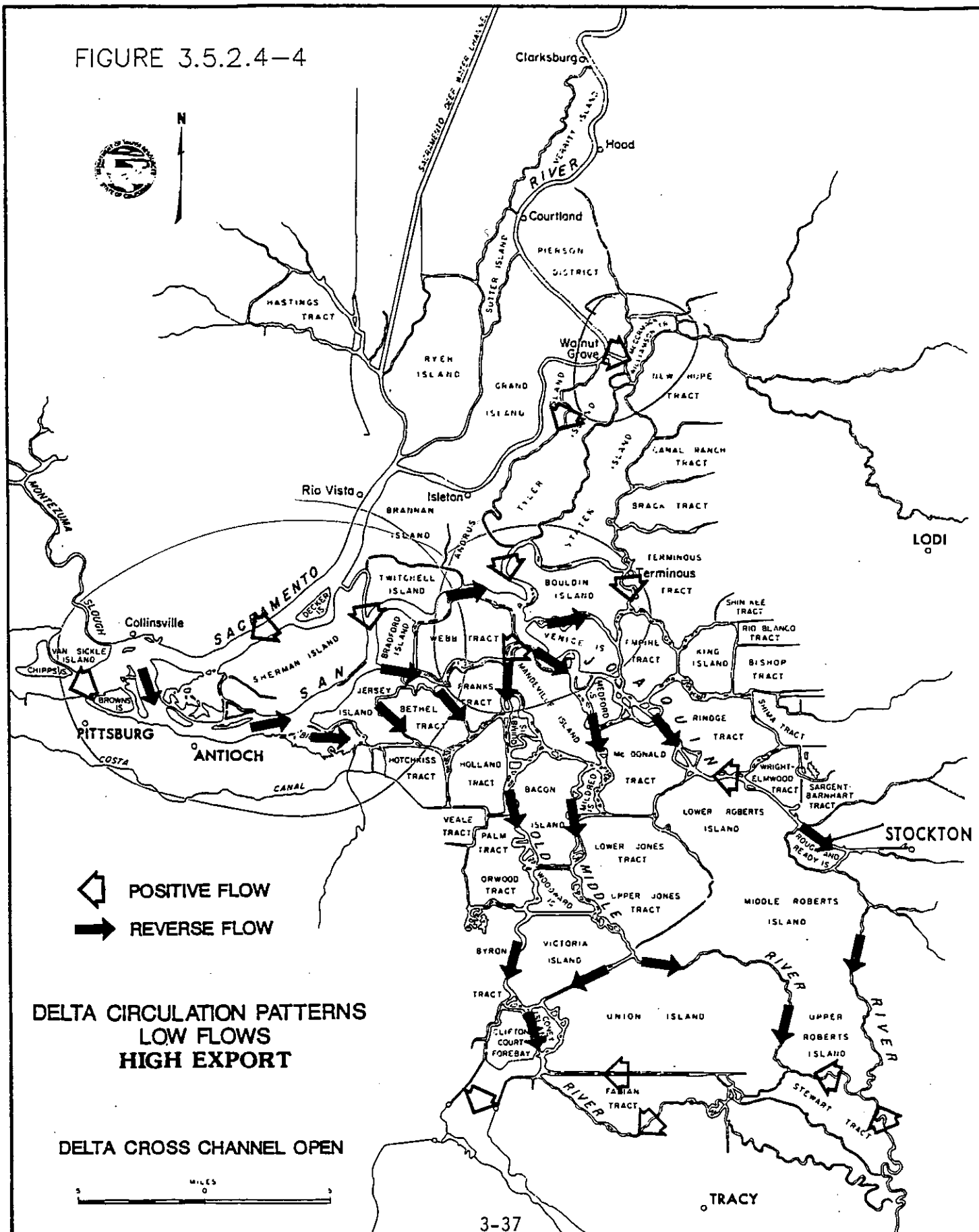
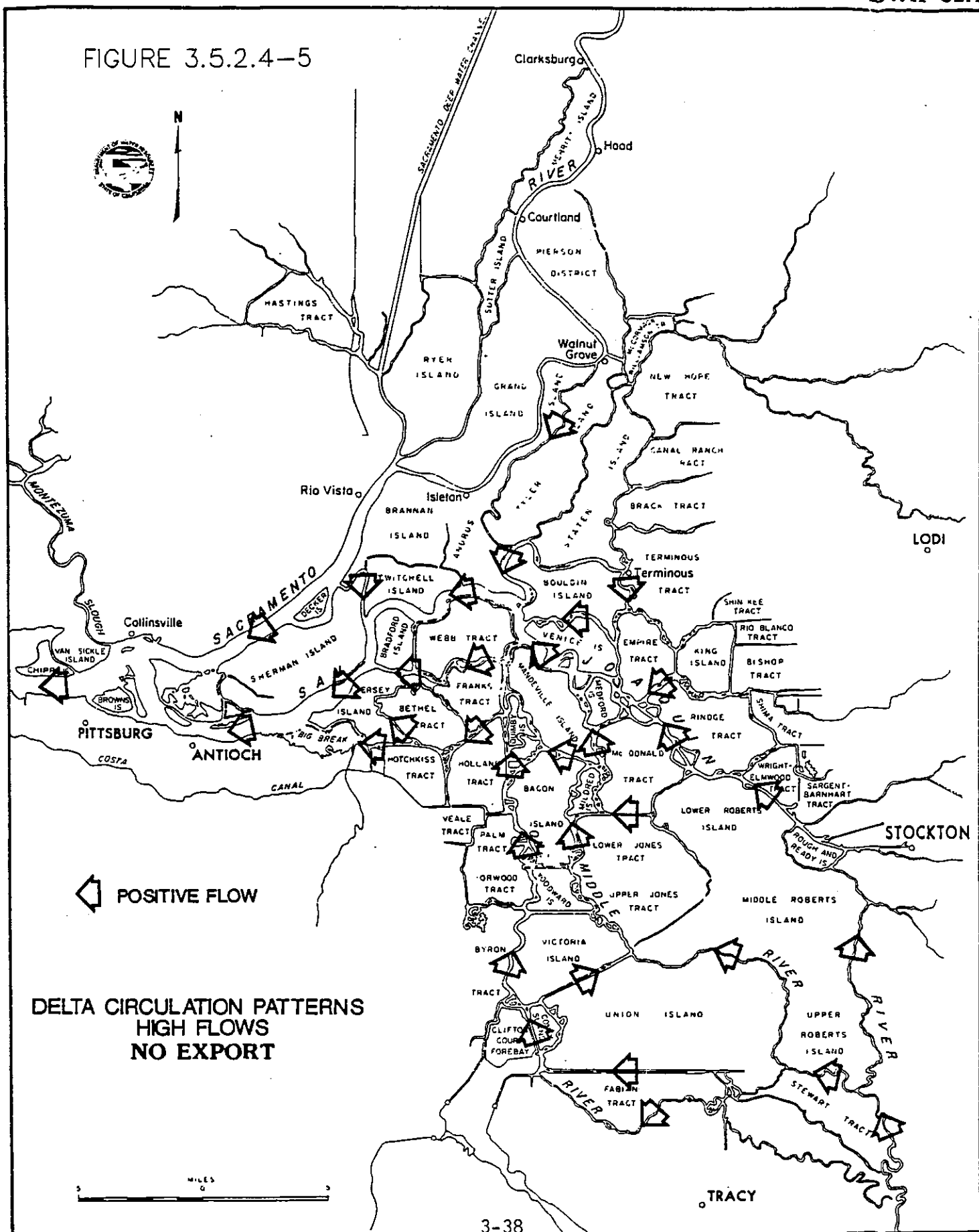

FIGURE 3.5.2.4-5



DELTA CIRCULATION PATTERNS
HIGH FLOWS
NO EXPORT

FIGURE 3.5.2.4-6

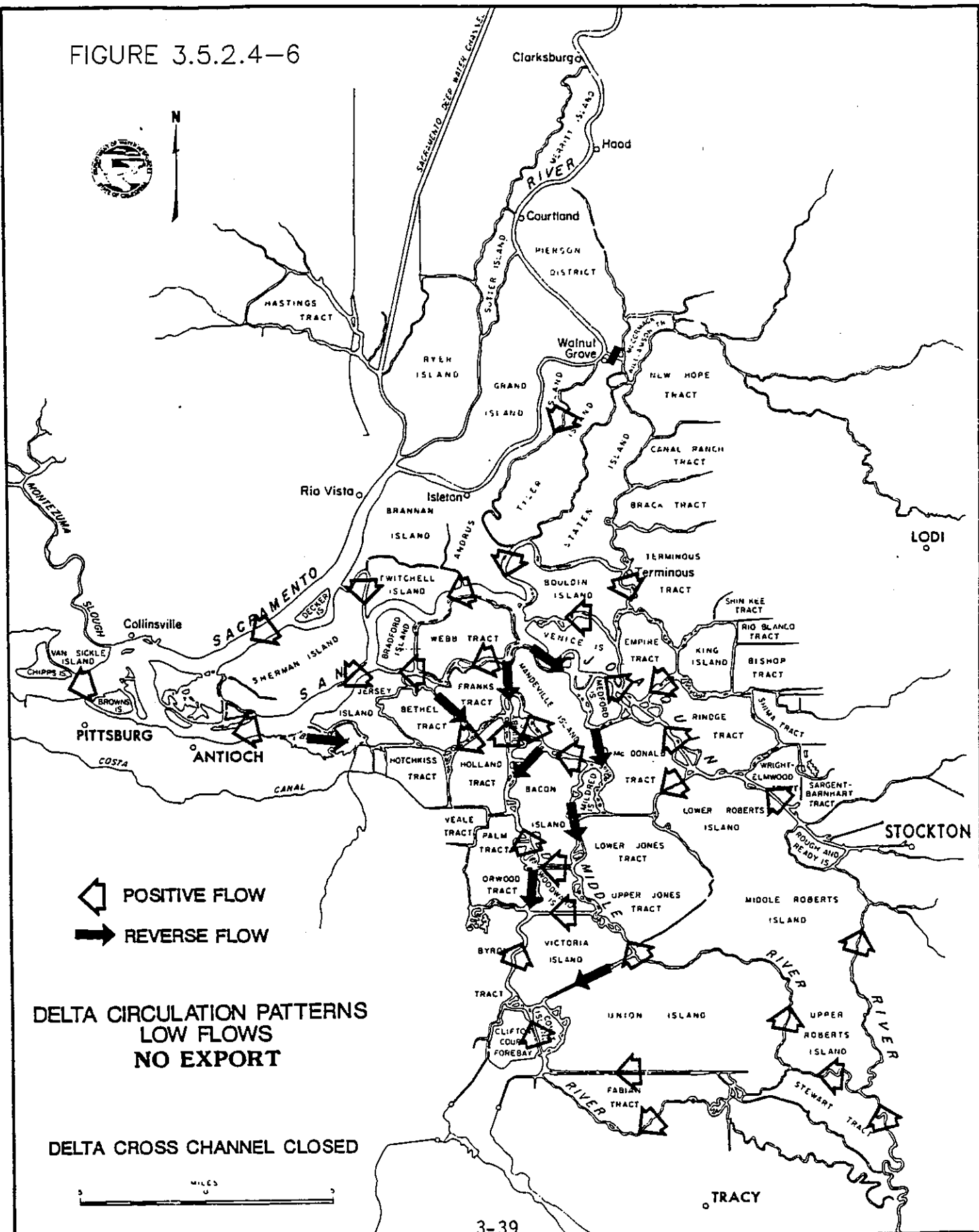
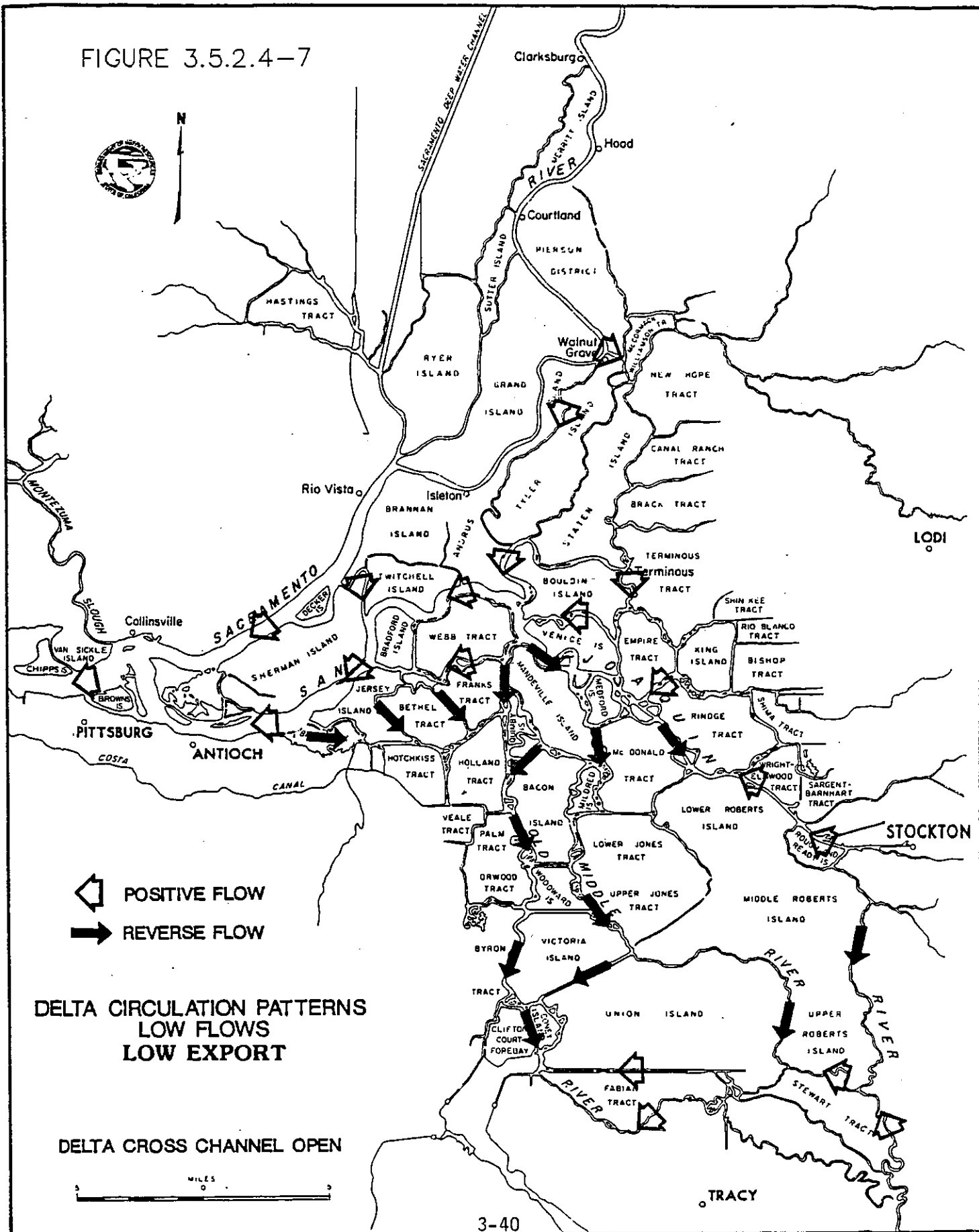

FIGURE 3.5.2.4-7



3.5.2.5 Salinity and Flow

Salinity is one of the major water quality factors affecting beneficial uses of Delta water supplies. Figure 3.5.2.5-1 shows that, as Delta outflows decrease, salinity increases^{1/} (DWR,58,1). Changes in Delta outflow during low flow periods have greater effects on salinity than similar changes during high flow periods. *to be expected*

Upstream storage facilities, in-basin depletions and Delta exports, have reduced winter and spring Delta outflows. Releases from upstream storage facilities, on the other hand, have increased summer and fall Delta outflows (SWRCB,14, II-1). These changes in flows have correspondingly changed the extent of salinity intrusion into the Delta. Figure 3.5.2.5-2 shows the maximum annual salinity intrusion into the Delta for the period 1920 through 1977 (DWR,60). Flow modifications due to storage facilities since the 1940's have generally kept salinity intrusion, as indicated by the 1000 ppm chloride line in the Delta, at a point further west, or downstream, than had been the case before that period. *interesting point* *what of 250 ppm line?*

3.5.3 Unimpaired Flow Conditions

The State Water Contractors (SWC) estimated the average monthly Delta outflow under natural flow conditions (Case A & B) and compared these to DWR's estimated unimpaired and 1990 level of development outflows (Figure 3.5.3-1) (DWR,30,26;SWC,353,1). Compared to DWR's unimpaired flow, the Delta outflow that the SWC estimated to be natural is smaller due to the consumptive use by vegetation of natural marshes and riparian areas, and also due to the absence of existing man-made levees. David R. Dawdy also estimated the average monthly Delta outflow under natural flow conditions and arrived at values somewhat higher than the SWC estimate (DAWDY,3,5). The difference between these estimates results mainly from different estimates of tule acreage, which in turn causes different amounts of consumptive use via plant evapotranspiration. DWR's estimate of unimpaired Delta outflow (DWR,36,3) differs from the SWRCB's estimate (SWRCB,3,M-2) primarily due to different estimates of Delta consumptive use under unimpaired conditions.

This Plan uses the unimpaired Delta inflows developed by both SWRCB and DWR to estimate unimpaired flows and salinities within the Estuary (SWRCB,3-5).

^{1/} In terms of EC at Collinsville in the western Delta. Historically, the salinity of waterways in the Delta has been expressed in chloride (Cl) or total dissolved solids (TDS) concentrations, and, more recently, in electrical conductivity (EC). However, sometimes it is necessary to convert one unit of salinity to another. Consequently, DWR has developed "Unit Conversion Equations" which are used to convert any one of the parameters to any of the others at various locations in the Delta using specific formulas for geographic location and water year type (DWR,61,1).

FIGURE 3.5.2.5-1

DWR-58
SALINITY-OUTFLOW RELATIONSHIP @ COLLINSVILLE
MONTHLY MEAN OF DAILY HIGH & DAILY MEAN EC

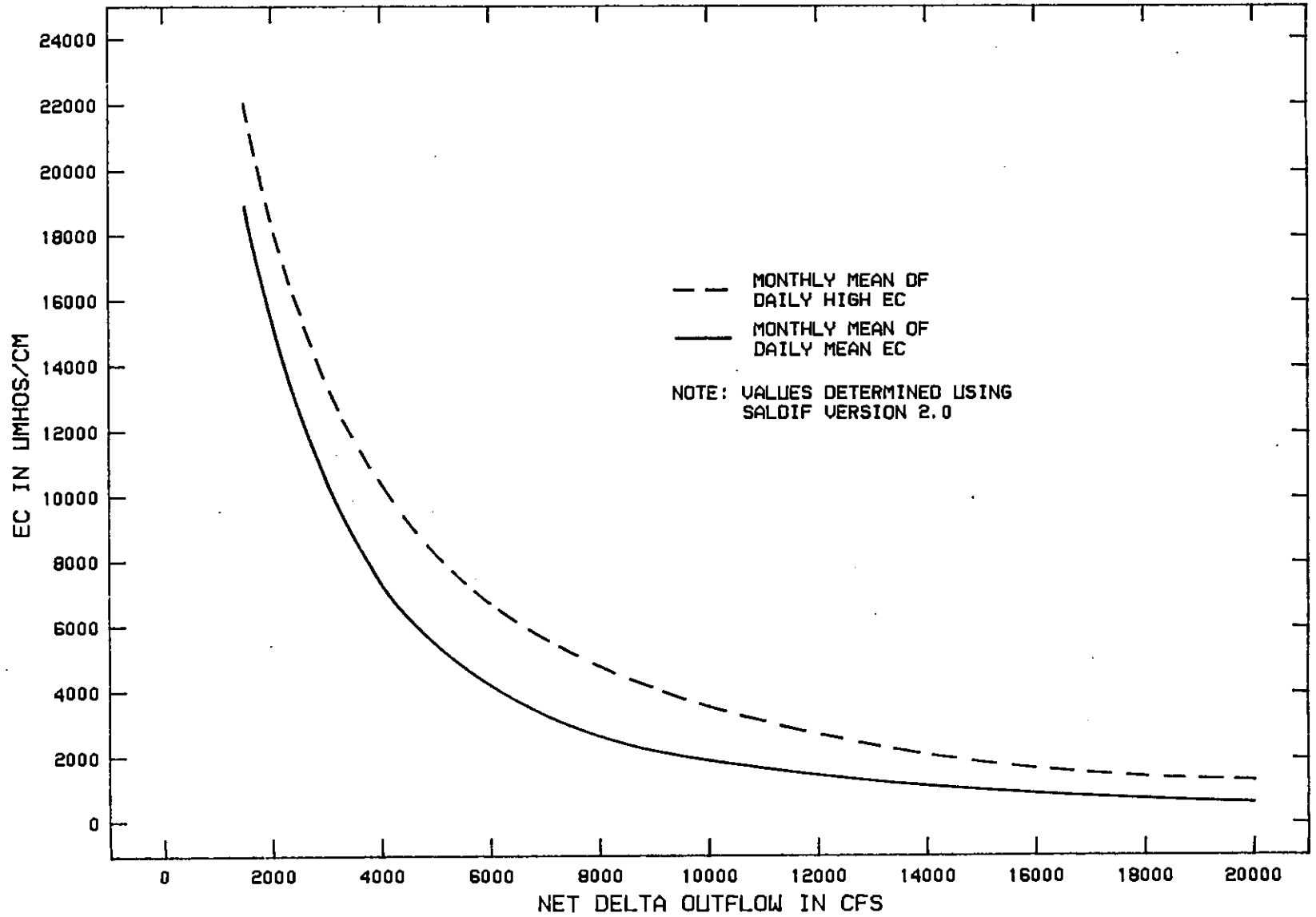

Note:
 Chloride concentration lines for 1920-1957
 were determined using data for calendar years
 (January through December), while those for 1958
 and later were determined using water years
 (e.g., 1958 implies October 1957-September 1958).
 An exception is 1931 which is presented according
 to post - 1957 plates.

FIGURE 3.5.2.5-2

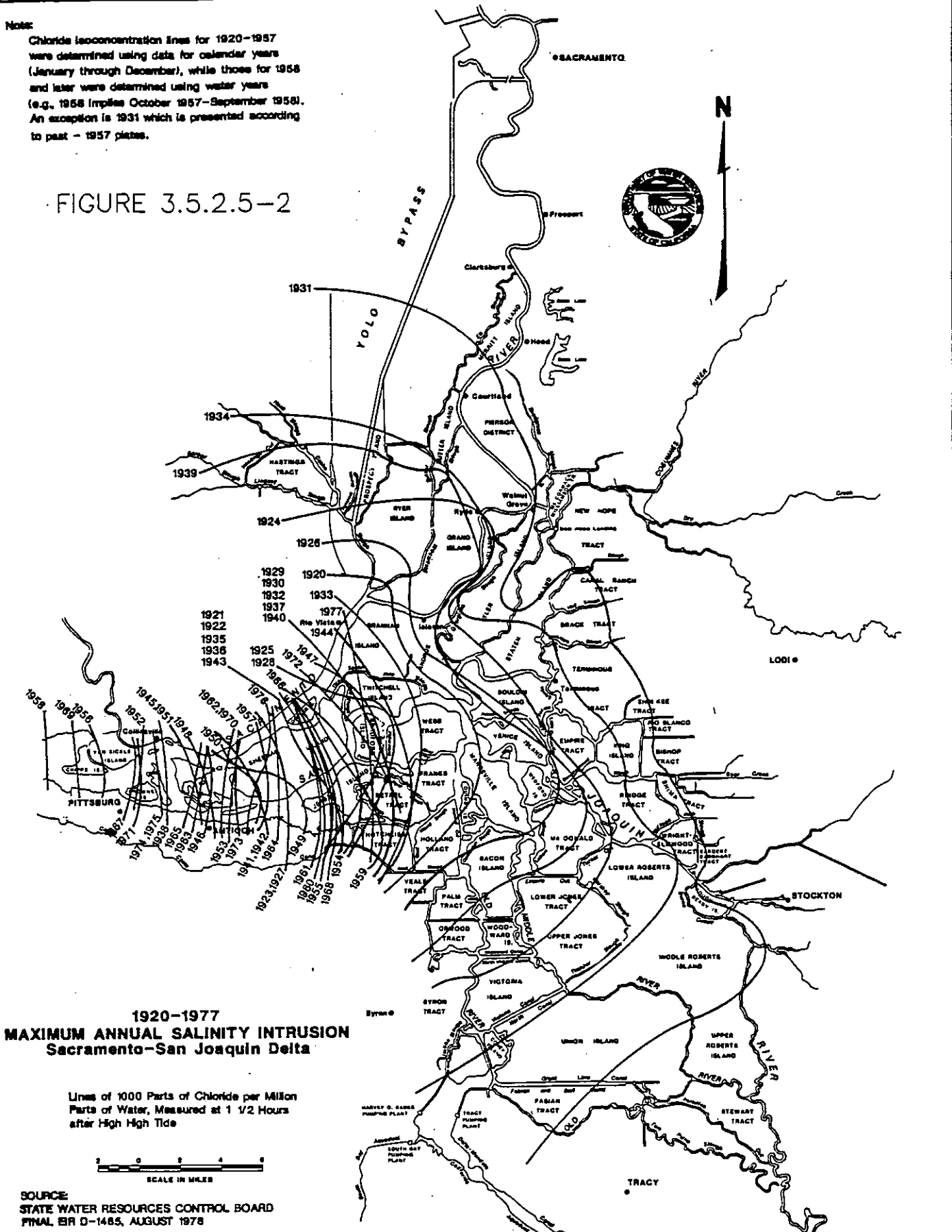
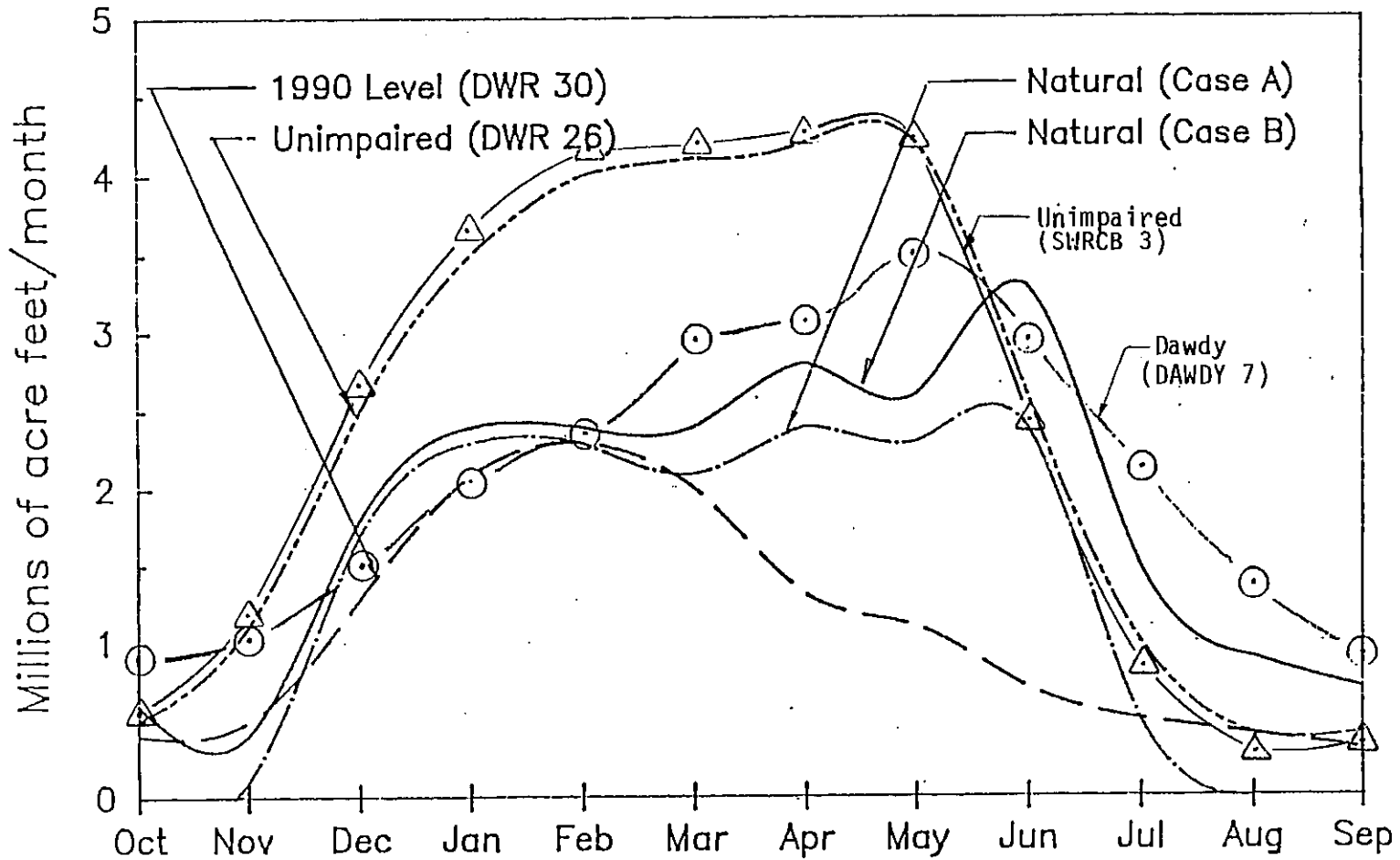

FIGURE 3.5.3-1

Average Monthly Delta Outflow



(From SWC 353)

| ANNUAL FLOW (MAF/YR) | <u>DWR Unimpaired</u> | <u>SWRCB Unimpaired</u> | <u>SWC Natural</u> | <u>DAWDY Natural</u> | <u>DWR 1990 L.O.D.</u> |
|----------------------|-----------------------|-------------------------|--------------------|----------------------|------------------------|
| | 28 | 28 | 16-22 | 25 | 14 |

3-44

3.5.4 Current Flow Conditions

The Delta Plan currently requires the CVP and SWP to meet specified flow and salinity standards within the Delta and Suisun Marsh (SWRCB,15,5). Figures 3.5.4-1 through -3, and Table 3.5.4-1 compare unimpaired Delta outflows with minimum outflow requirements set by the Delta Plan objectives (DWR,1986,1). DWR has established (Table 3.5.4-2) the minimum outflow requirements to meet The Delta Plan objectives (DWR,1986,1). In some months such as August, Delta Plan flow requirements can actually be above the unimpaired amounts available(Figure 3.5.4-1).

TABLE 3.5.4-1
TOTAL ANNUAL DELTA OUTFLOWS:
UNIMPAIRED FLOW AND CURRENT FLOW CONDITIONS
BY WATER YEAR TYPE^{1/}

| Water Year Type | Unimpaired Flow (TAF) ^{2/} | | Current Flow ^{3/} | |
|-----------------|-------------------------------------|--------|----------------------------|--------|
| | Low | High | Low | High |
| Wet | 29,441 | 56,686 | 16,034 | 34,715 |
| Above Normal | 22,997 | 32,368 | 6,554 | 16,145 |
| Below Normal | 18,428 | 26,110 | 4,684 | 11,021 |
| Dry | 15,334 | 18,133 | 4,785 | 8,707 |
| Critical | 5,793 | 13,279 | 3,273 | 4,848 |

1/ Assuming 1922 through 1978 hydrology.
2/ Thousands of acre-feet.
3/ Delta Plan requirements.

3.6 San Francisco Bay and Basin

- includes Suisun Marsh

3.6.1 Physical Description: San Francisco Bay

The boundary of San Francisco Bay (SWRCB,3,3) extends from the Golden Gate Bridge on the west to the Delta on the east and includes: areas subject to tidal action up to mean high tide, areas 100 feet landward of the mean high tide shoreline, saltponds, and managed wetlands.

{ This definition includes the entire Suisun Marsh as part of San Francisco Bay. Suisun Marsh, as defined by Section 29101 of the Public Resources Code, includes the waterways north of Suisun, Grizzly, and Honker bays which are subject to tidal action and the adjacent lands whose management is dependent on tidal action of these waters. This definition generally follows the San Francisco Bay Conservation and Development Commission (BCDC) boundary as defined in Government Code Sections 66610 and 66611.

ESTIMATED DELTA OUTFLOW REQUIREMENTS
OF THE
1978 DELTA PLAN

TABLE 3.5.4-2

| Time Period | Delta Outflow Requirements in Cfs (acre-feet) | | | | | | | | | |
|-----------------------------|---|----------------------------------|---------------------------------|----------------------------------|---------------------------------|----------------------------------|---------------------------------|---------------------------------|---------------------------------|---------------------------------|
| | Wet | | Above Normal | | Below Normal | | Dry | | Critical | |
| | Lower Requirements | Upper Requirements | Lower Requirements | Upper Requirements | Lower Requirements | Upper Requirements | Lower Requirements | Upper Requirements | Lower Requirements | Upper Requirements |
| January | 4,500 ² (276,700) | 6,600 ¹ (405,800) | 4,500 ² (276,700) | 6,600 ¹ (405,800) | 4,500 ² (276,700) | 6,600 ¹ (405,800) | 4,500 ² (276,700) | 6,600 ¹ (405,800) | 4,500 ² (276,700) | 6,600 ¹ (405,800) |
| February | 10,000 (555,400) | 10,000 (555,400) | 4,500 ² (249,900) | 12,000 (666,500) | 4,500 ² (249,900) | 12,000 (666,500) | 4,500 ² (249,900) | 6,600 ¹ (366,600) | 4,500 ² (249,900) | 6,600 ¹ (366,600) |
| March 1-17 | 10,000 (337,200) | 10,000 (337,200) | 4,500 ² (151,700) | 12,000 (404,600) | 4,500 ² (151,700) | 12,000 (404,600) | 4,500 ² (151,700) | 6,600 ¹ (222,500) | 4,500 ² (151,700) | 6,600 ¹ (222,500) |
| March 18-31 | 10,000 (277,700) | 10,000 (277,700) | 4,500 ² (125,000) | 12,000 (333,200) | 4,500 ² (125,000) | 12,000 (333,200) | 4,500 ² (125,000) | 6,600 ¹ (183,300) | 4,500 ² (125,000) | 6,600 ¹ (183,300) |
| April | 10,000 (595,000) | 10,000 (595,000) | 7,600 (452,200) | 7,600 (452,200) | 7,600 (452,200) | 7,600 (452,200) | 7,600 (452,200) | 7,600 (452,200) | 4,500 ³ (267,800) | 6,700 ³ (398,700) |
| May 1-5 | 10,000 (99,200) | 10,000 (99,200) | 7,600 (75,400) | 7,600 (75,400) | 7,600 (75,400) | 7,600 (75,400) | 7,600 (75,400) | 7,600 (75,400) | 4,500 ³ (44,600) | 6,700 ³ (66,400) |
| May 6-31 | 7,600 (391,900) | 14,000 ⁴ (722,000) | 7,600 (391,900) | 14,000 ⁴ (722,000) | 7,600 (391,900) | 11,400 ⁴ (587,900) | 7,600 (391,900) | 7,600 (391,900) | 3,900 (201,100) | 3,900 (201,100) |
| June 1-15 | 7,600 (226,100) | 14,000 ⁴ (416,500) | 7,600 (226,100) | 10,700 ⁴ (318,400) | 7,600 (226,100) | 9,500 ⁴ (282,600) | 7,600 (226,100) | 7,600 (226,100) | 3,900 (116,000) | 3,900 (116,000) |
| June 16-20 | 7,600 (75,400) | 14,000 ⁴ (138,300) | 7,600 (75,400) | 10,700 ⁴ (106,100) | 7,600 (75,400) | 9,500 ⁴ (94,200) | 4,700 (46,600) | 4,700 (46,600) | 3,900 (38,700) | 3,900 (38,700) |
| June 21-30 | 7,600 (150,700) | 14,000 ⁴ (227,700) | 7,600 (150,700) | 10,700 ⁴ (212,200) | 5,400 (107,100) | 9,500 ⁴ (188,400) | 4,700 (92,200) | 4,700 (92,200) | 3,900 (77,400) | 3,900 (77,400) |
| July | 7,600 (467,300) | 10,000 ⁴ (614,900) | 6,700 (412,000) | 7,700 ⁴ (473,500) | 5,400 (332,000) | 6,500 ⁴ (399,700) | 4,700 (289,000) | 4,700 (289,000) | 3,900 (239,800) | 3,900 (239,800) |
| August 1-15 | 7,600 (226,100) | 7,600 (226,100) | 6,700 (195,300) | 6,700 (195,300) | 5,400 (160,700) | 5,400 (160,700) | 4,700 (139,800) | 4,700 (139,800) | 3,900 (116,000) | 3,900 (116,000) |
| August 16-31 | 2,500 (79,300) | 2,500 (79,300) | 2,500 (79,300) | 2,500 (79,300) | 2,500 (79,300) | 2,500 (79,300) | 2,500 (79,300) | 2,500 (79,300) | 2,500 (79,300) | 2,500 (79,300) |
| September | 2,500 (148,800) | 2,500 (148,800) | 2,500 (148,800) | 2,500 (148,800) | 2,500 (148,800) | 2,500 (148,800) | 2,500 (148,800) | 2,500 (148,800) | 2,500 (148,800) | 2,500 (148,800) |
| October | 4,500 (276,700) | 4,500 (276,700) | 4,500 (276,700) | 4,500 (276,700) | 4,500 (276,700) | 4,500 (276,700) | 3,500 ⁵ (215,200) | 4,500 (276,700) | 3,500 ⁵ (215,200) | 4,500 (276,700) |
| November | 4,500 (267,800) | 4,500 (267,800) | 4,500 (267,800) | 4,500 (267,800) | 4,500 (267,800) | 4,500 (267,800) | 3,500 ⁵ (208,300) | 4,500 (267,800) | 3,500 ⁵ (208,300) | 4,500 (267,800) |
| December | 4,500 (276,700) | 4,500 (276,700) | 4,500 (276,700) | 4,500 (276,700) | 4,500 (276,700) | 4,500 (276,700) | 3,500 ⁵ (215,200) | 4,500 (276,700) | 3,500 ⁵ (215,200) | 4,500 (276,700) |
| Total in 1000s acre-feet | 4,728 | 5,666 | 3,836 | 5,418 | 3,673 | 5,100 | 3,384 | 3,942 | 2,772 | 3,482 |

1 When the storages at any two of Shasta, Croville and Folsom Reservoirs are encroached in their flood control reservation.
 2 If storages are encroached (see No. 1) then 6,600.
 3 If SWP and CVP users are taking deficiencies in firm supplies then 4,500 cfs for critical year.
 4 If subnormal snowmelt then use lower limit.
 5 When project users (CVP and SWP) are taking deficiencies, otherwise 4,500 cfs.

Department of Water Resources
Division of Operations and Maintenance
March 1986

FIGURE 3.5.4-1

CURRENT AND UNIMPAIRED DELTA OUTFLOW

USING 1922-1978 MONTHLY AVERAGE HYDROLOGY

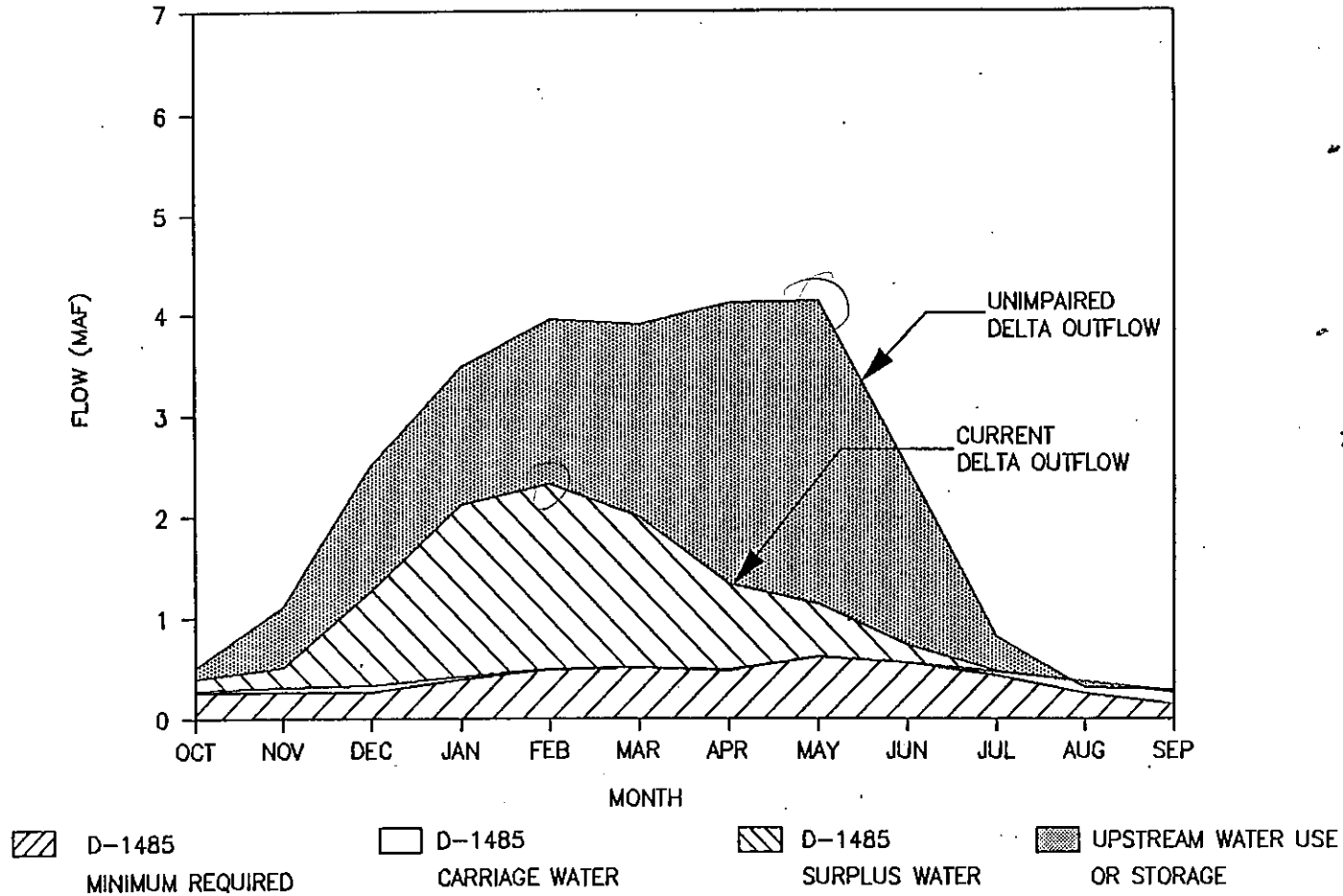

• Unimpaired Flow hydrograph peaks in May

• Current Delta Outflow peaks in February!

3-47

FIGURE 3.5.4-2

UNIMPAIRED DELTA OUTFLOW

USING 1922-1978 MONTHLY AVERAGE HYDROLOGY

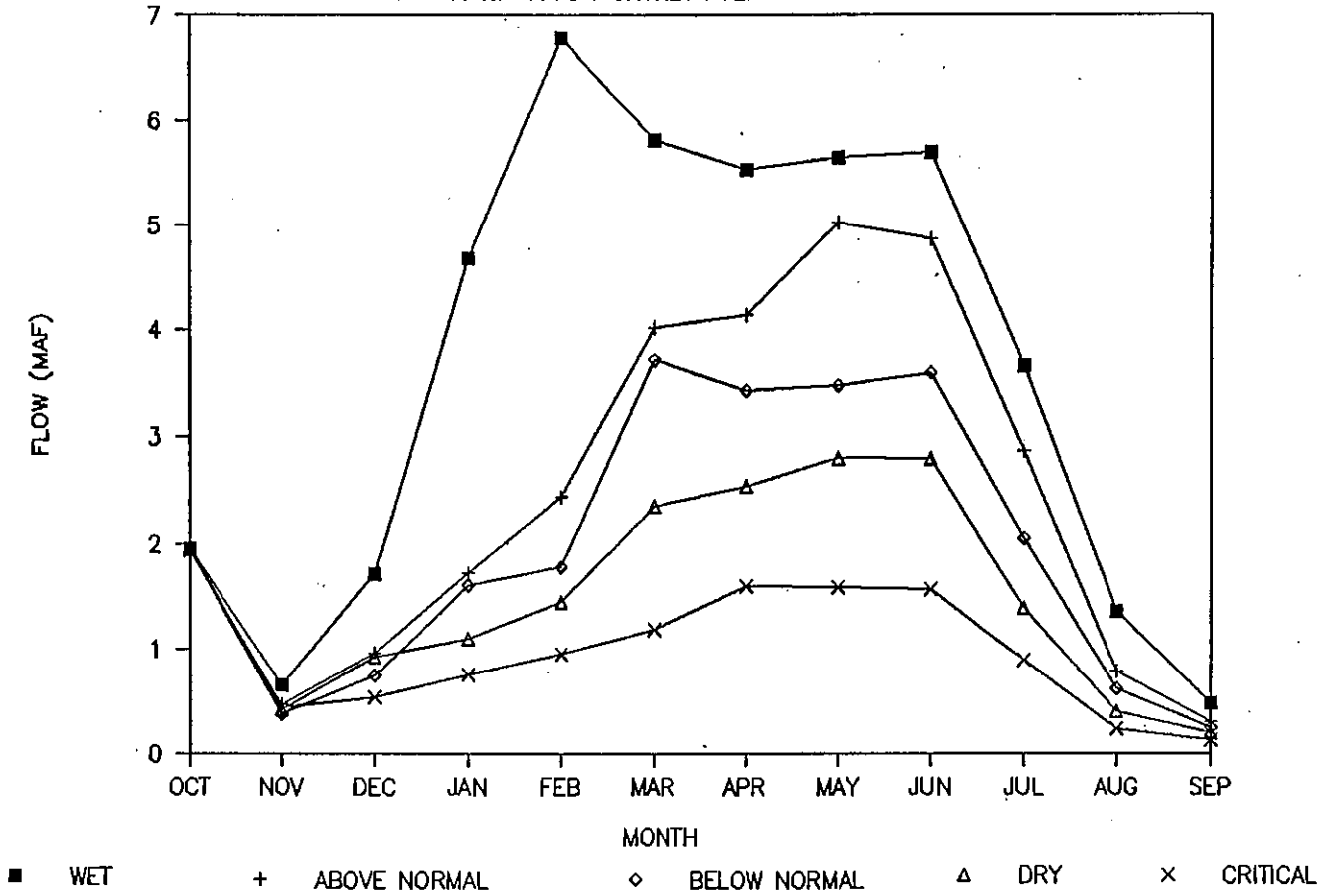

3-48

FIGURE 3.5.4-3

MINIMUM D-1485 REQUIRED DELTA OUTFLOW USING 1922-1978 MONTHLY AVERAGE HYDROLOGY

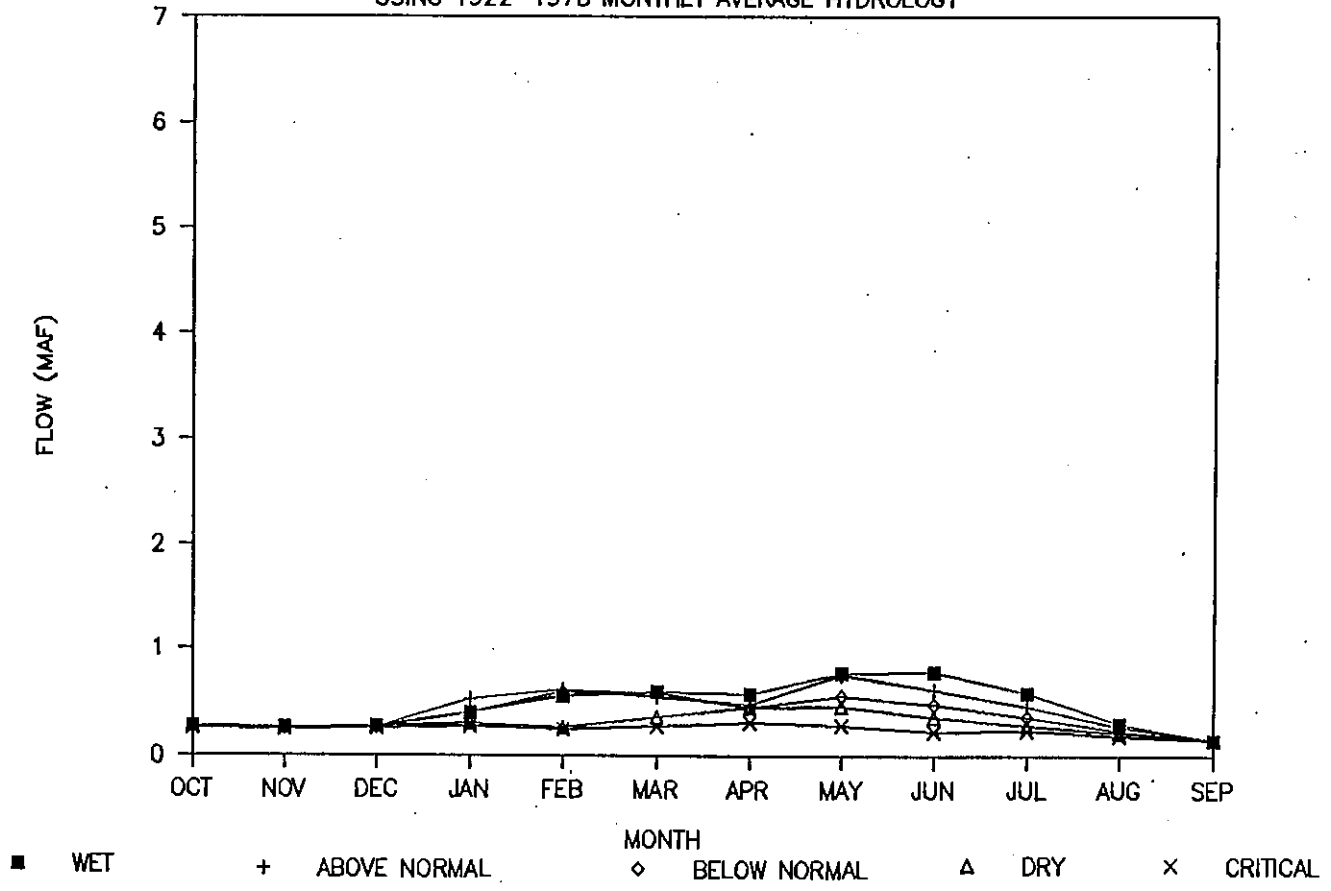

3-49

San Francisco Bay consists of about 805 square miles (515,000 acres) (BCDC,1982) including: 420 square miles (269,000 acres) of open water, 125 square miles (80,000 acres) of tidal marshes; 110 square miles (70,000 acres) of Suisun Marsh; 80 square miles (51,000 acres) of diked historic baylands, 70 square miles (45,000 acres) of saltponds and other managed wetlands.

3.6.2 Physical Description: San Francisco Bay Basin

The San Francisco Bay Basin, Figure 3.1-3, is the area contributing runoff to the Bay. This description differs somewhat from the Basin Plan boundary of Region 2 (RWQCB,2,1975) which includes the entire San Francisco Bay Basin as well as coastal area from Dillon Beach to San Gregorio. The total area of the Basin is about 3,870 square miles, or 2,477,000 acres (SWRCB,3,Appendix F). The major streams contributing to local runoff to the Bay are Napa, Petaluma, and Guadalupe rivers, and Alameda, Coyote, Sonoma and Walnut creeks. Water is imported to the Basin via the following water projects (see Figure 3.1-3):

water imports to SF Bay Basin

Mokelumne Aqueduct, Hetch Hetchy Aqueduct, South Bay Aqueduct, Contra Costa Canal, Putah South Canal, Sonoma Petaluma Aqueducts, North Bay Aqueduct (begun in 1988), and City of Vallejo intake at Cache Slough (ended when the North Bay Aqueduct began operation).

In years of normal runoff, the San Francisco Bay Basin contributes about ten percent of the total runoff to the Estuary (SWRCB,3,3). From 1970 to 1982, rainfall discharge averaged about 57 percent of the total runoff from the Bay Basin, with the rest being municipal and industrial discharges (SWRCB,3, Appendix R and 35).

3.6.3 Hydrology: San Francisco Bay

San Francisco Bay, excluding the Delta, but including saturated mudflats, has a total water surface area of approximately 300,000 acres or 470 square miles at mean lower low water (MLLW). The area, mean depth and volume of the subregions of the Bay are summarized in Table 3.6.2.1-1 (Cheng and Garner, 1984). The locations of the Bay's subregions are shown in Figure 3.6.2.1-1.

San Francisco Bay is unique among American estuaries in having two arms or reaches, the northern reach including San Pablo and Suisun bays, and the southern reach extending from the Oakland-Bay Bridge to Mountain View. The northern reach receives discharge from the Sacramento-San Joaquin Delta, approximately 90 percent of the freshwater inflow to San Francisco Bay. The southern reach receives only local runoff and is considered a tributary estuary. Between the two reaches is the central Bay bounded by the Richmond-San Rafael, Oakland-Bay, and Golden Gate bridges. The central Bay is deeper either of the two reaches, is more ocean-like in character and provides most of the inflow to the South Bay (SWRCB,4,18-19).

FIGURE 3.6.2.1-1 Location map of San Francisco Bay showing the four sub-regions and the Sacramento-San Joaquin Delta.
 (Source: Denton and Hunt, 1986)

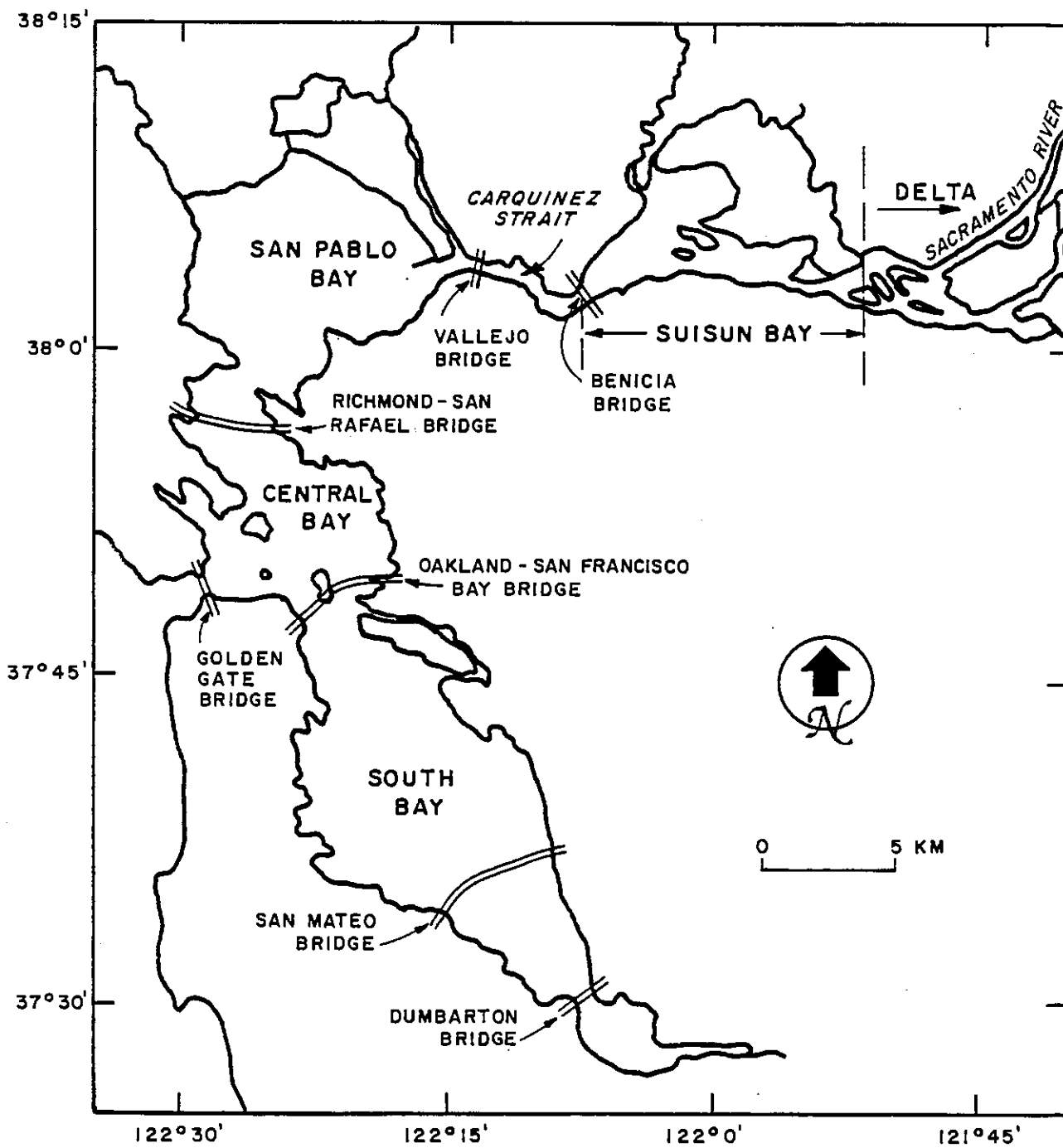

- Freshwater Inflow

Excluding water from the Delta, freshwater inflows come into the Bay primarily via the Napa and Petaluma rivers which provide local drainage to the northern part of San Pablo Bay; via Walnut Creek and Suisun Slough which enter Suisun Bay; Pinole and Novato creeks which enter the San Pablo Bay; and San Lorenzo, Matadero and Coyote creeks which enter the south Bay. In addition, there are many municipal and industrial wastewater treatment plants and combined sewer overflows that contribute to inflows (SWRCB,3,11-16). Because these freshwater inflows into the Bay are small compared to Delta outflow, they are often ignored in calculations of total inflow to the Bay. In the southern portion of the south Bay, all tributary streams have intermittent, local runoff (excluding effluent) (BISF,6, 56-59).

- Tidal Exchange

Immense flows are exchanged between the bay and the ocean on tidal currents driven by the gravitational attraction between the earth, the sun and moon. Their exact size is not known (USGS,3 updated,5), but tidal flows entering San Francisco Bay at the Golden Gate Bridge have been estimated to average greater than 2.5 million cfs (BISF,6,51). Because of complex circulation eddies outside the entrance to the Bay, only a portion of the water flooding in from the ocean is "new" water, i.e., water which has not entered the Bay for at least several tidal cycles (Denton and Hunt, 1986).

Tidal flows through Golden Gate

- Central Bay

Flood tides first entering the central Bay pass on either side of Alcatraz Island, through Raccoon Strait between the Tiburon Peninsula and Angel Island; tides then flow northwards through San Pablo Strait into San Pablo Bay and southwards beneath the Oakland-Bay Bridge into south Bay (Figure 3.6.2.1-2).

- San Pablo Bay

The main tidal flows in San Pablo Bay pass along a natural channel between San Pablo Strait, across the shallow Pinole Shoal and through Carquinez Strait to the east (Figure 3.6.2. 1-3). The maximum depth in the two straits is about 83 feet, decreasing to about 20-25 feet over Pinole Shoal. A 600 foot wide shipping channel, dredged to a depth of 35 feet, across the shallow Pinole Shoal provides shipping access to the Mare Island Naval Shipyard and the ports of Sacramento and Stockton. The areas north and south of the shipping channel are very shallow; one half of the area of San Pablo Bay, for example, has a depth of less than six feet.

WSP

Table 3.6.2.1-1
 BATHYMETRIC DATA FOR SAN FRANCISCO BAY
 (Adapted from Cheng and Gardner, 1984)

| Region | Surface Area at MLLW ^{1/} (sq mi) | Mean Depth ^{2/} (ft) | Mean Volume (AF) |
|--------------------------|--|-------------------------------------|------------------------|
| Central Bay | 103 | 35 | 2,307,000 |
| San Pablo Bay | 105 | 9 | 605,000 |
| Carquinez Strait | 12 | 29 | 223,000 |
| Suisun Bay ^{3/} | 36 | 14 | 323,000 |
| South Bay | 214 | 11 | 1,507,000 |
| San Francisco Bay | 470 | 17 | 4,965,000 |

1/ Excluding the Delta but including saturated mudflats

2/ These depths do not agree with those of Section 3.6.1 because of the inclusion of saturated mudflats.

FIGURE 3.6.2.1-2 Map of the Central Bay and the region immediately outside Golden Gate.
 The dotted line shows the 60 ft depth contour and the dashed line is the 18 ft contour.
 (Source: Denton and Hunt, 1986)

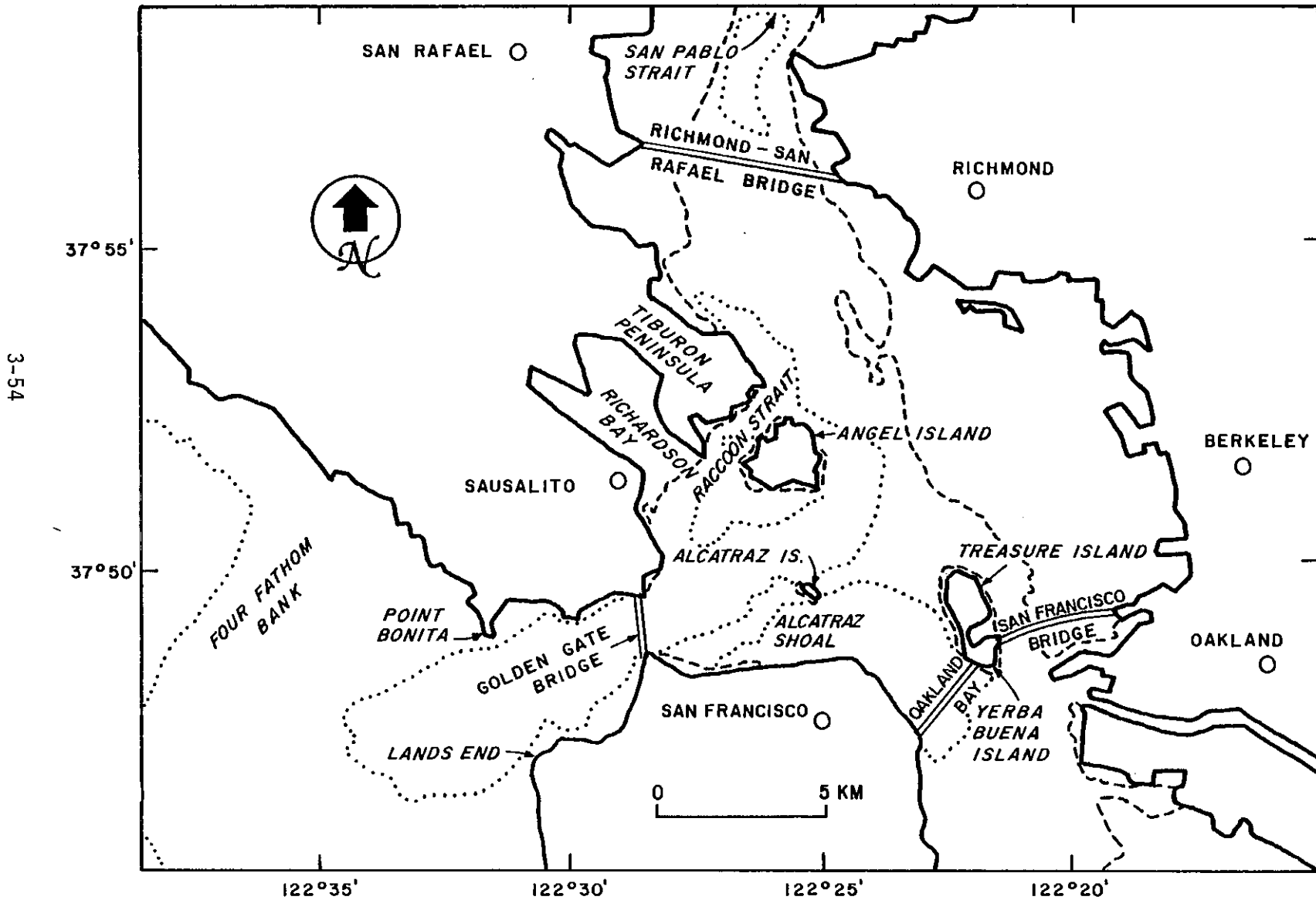
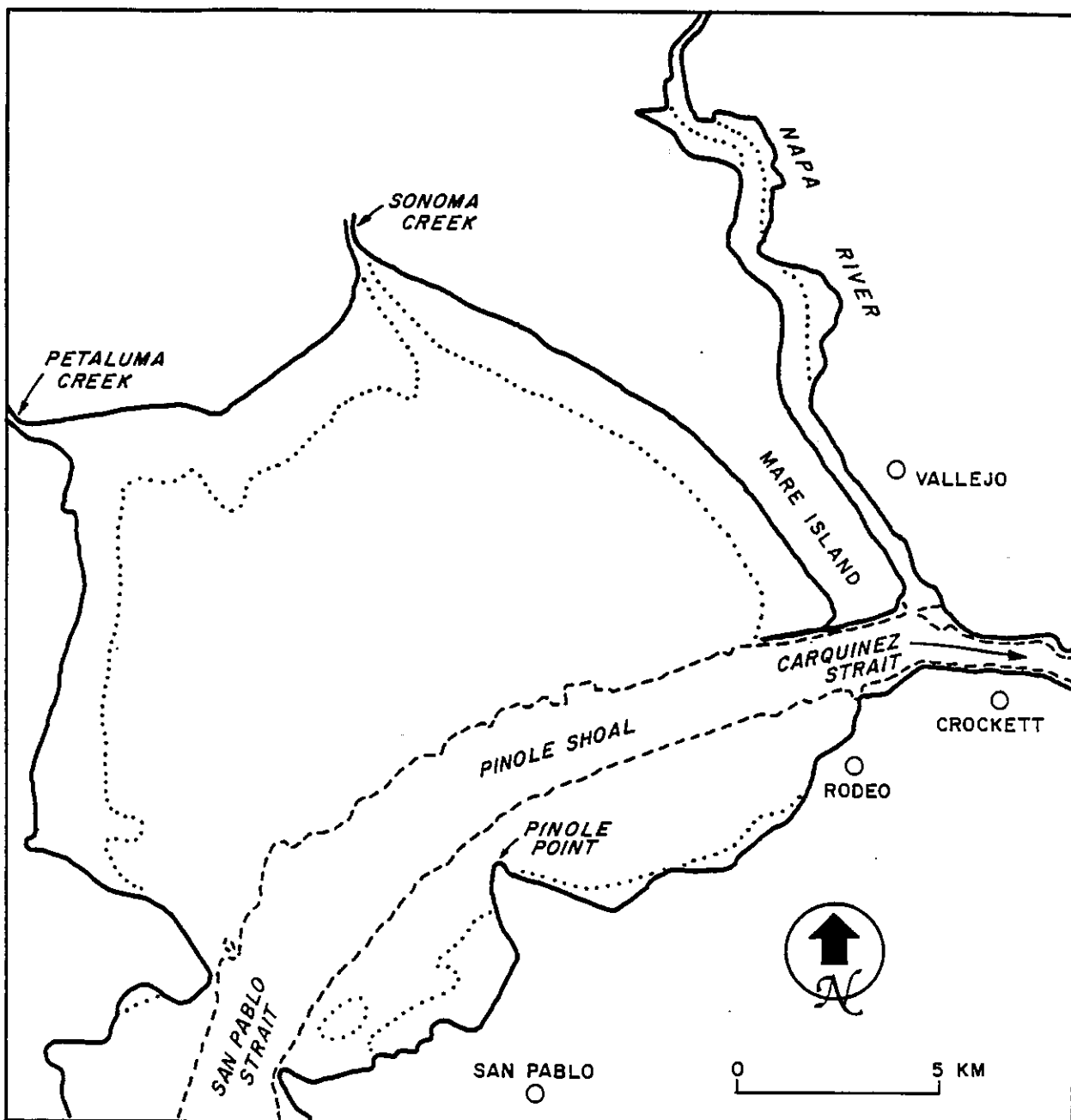

FIGURE 3.6.2.1-3 Map of San Pablo Bay. The 18 ft (5.5) depth contour is plotted as a dashed line and indicates the location of the main channel. The dotted line shows the extent of the mudflats around the bay.

(Source: Denton and Hunt, 1986)



- Suisun Bay and Marsh

Having the smallest surface area of the four embayments, Suisun Bay is situated in the northeastern reach of San Francisco Bay between the cities of Benicia and Antioch (Figure 3.6.2.1-4). The entire Suisun Bay and Marsh area, including two subbays, Grizzly and Honker, consists of 84,190 acres, of which about 26,880 acres are bays and sloughs. The remaining 57,310 acres are diked and managed wetlands. (Approximately 45,710 acres of managed wetlands are privately owned and used primarily for duck hunting; 10,490 acres are owned by the State of California as a waterfowl management area, wildlife refuge and public recreation area; and 1,110 acres are controlled by the U.S. Navy {SWRCB, 1978}).

*null
zone
in
Suisun
Bay*

The main tidal flows are along a few well-defined channels separated by islands and shallow gravel banks. During most periods of outflow from the Delta, Suisun Bay is the location of the estuary's 'null zone' (defined as the region in a partially or well-mixed estuary where the residual bottom currents are effectively zero). Upstream of this area there is a net downstream, or seaward, residual velocity along the bottom caused by river inflow. Seaward of the null zone, gravitational circulation produces a transport, for the most part toward land, of denser more saline water along the bottom. The null zone is significant because it is the theoretical upstream boundary of the entrapment zone, the area in the estuary where suspended materials, including biota, accumulate (USBR, 112,407). Figure 3.6.2.1-5, a diagram of estuarine circulation for a partially mixed estuary such as Suisun Bay, illustrates the relationships between flows, salinities, and the null and entrapment zones (CCCWA/EDF, 1,56).

The salinity of water within Suisun Bay varies seasonally with the freshwater outflow from the Delta. Salinities of the water in Montezuma Slough are lower than in Suisun Bay itself for a longer period of time each year because Slough lies further upstream and receives freshwater inflow from the Sacramento River and other tributary channels first. For the most part, low salinity water stays in the Suisun Marsh channels later in the spring and in early summer, but higher salinity water remains later in the fall before the Marsh channels are flushed by increasing Delta outflows (SWRCB, 1978).

By most definitions, Suisun Bay includes Suisun Marsh, located to the north of the main body of the Bay. The Marsh was a natural brackish water marsh prior to widespread reclamation for agricultural purposes in the early 1900's. However, because the agricultural developments were largely unsuccessful in the 1930's, the reclaimed marsh lands were gradually converted to private duck clubs and state Wildlife Management Areas.

FIGURE 3.6.2.1-4 Map of Suisun Bay. The dashed line shows the 18 ft (5.5) depth contour.
(Source: Denton and Hunt, 1986)

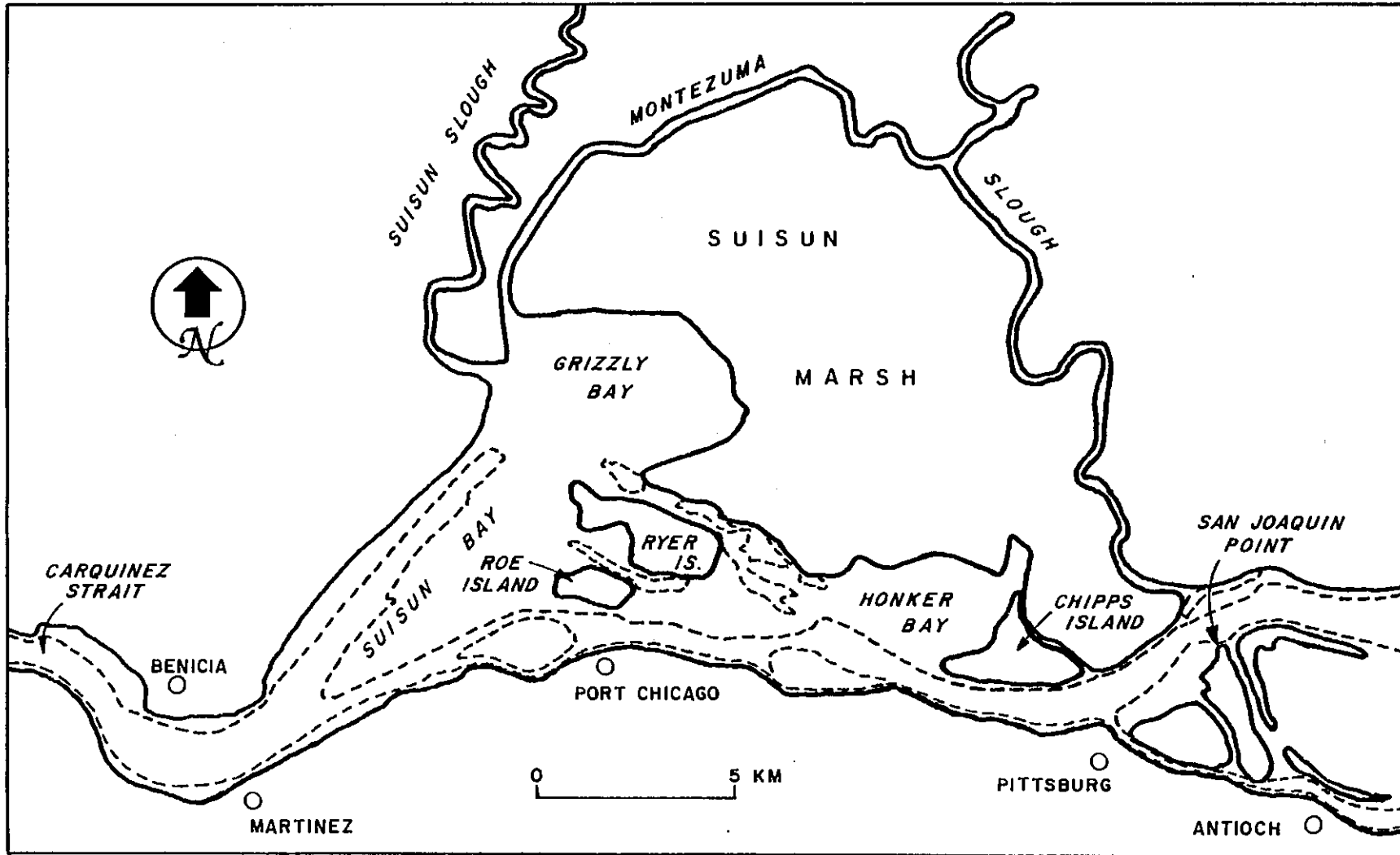
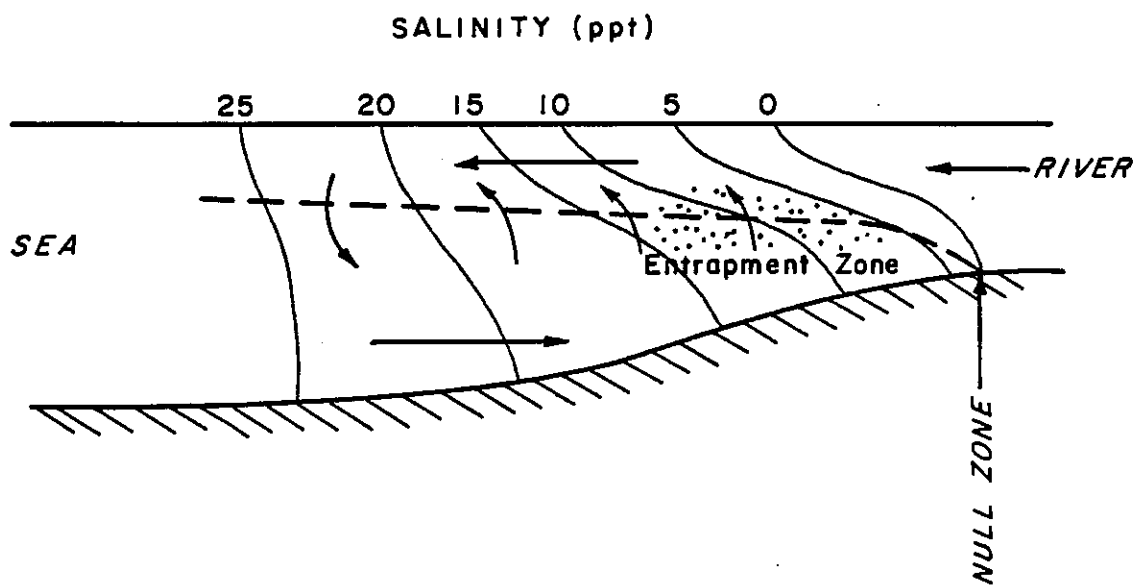

FIGURE 3.6.2.1-5 Diagram of Estuarine Circulation for a Partially Mixed Estuary
(Source: CCCWA/EDF, 1, Figure 12)



- South Bay

The entrance to the south Bay from the central Bay is separated by Treasure and Yerba Buena islands into two passages, one to the east that is 30 to 35 feet deep and one to the west that is 70 feet deep at the Oakland-San Francisco Bay Bridge (Figure 3.6.2.1-6). Because the south Bay receives only minor amounts of local freshwater inflows, it is essentially a tidal lagoon. Tidal currents in south Bay are greatest along the main channel on the western side of the Bay. In the south Bay, evidence suggests three distinct mixing zones exist between: (1) the Oakland-San Francisco Bay Bridge and San Bruno Shoal, a relatively shallow area with water depths of about 11 to 26 feet between Bay Farm Island and Oyster Point; (2) San Bruno Shoal and the San Mateo Bridge; and (3) the area south of the San Mateo Bridge. A 500 foot wide, 29 feet deep navigation channel is maintained across the San Bruno Shoal. The salinity of the south Bay remains close to the level of the ocean (33 to 35 parts per thousand) throughout most of the year, except during periods of high Delta outflow. During particularly hot, dry periods when evaporation rates are high, the south Bay can act as a negative estuary where salinity levels actually increase in the southern extremities (Denton and Hunt, 1986).

Currents differ in the south Bay according to Delta outflows. From analyses of current data for summer wind conditions and low Delta discharges, the USGS has concluded that net currents in south Bay north of San Bruno Shoal are southward along the eastern side and northward along the western side of the Bay (USGS, 3 updated, 25). During the season of high Delta outflows, a lens of fresher water can form on the surface of the northern reach of San Francisco Bay. This lens of fresher water eventually spreads southwards into the central and south Bays over more saline water that is flowing toward the ocean. This process, which provides the major source of freshwater for the South Bay, is known as gravitational overturn (Denton and Hunt, 1986). The significant density difference between the two flows acts to inhibit vertical mixing. When Delta outflow subsides, reintrusion of ocean water raises the salinities in central Bay above those in south Bay, and the direction of circulation reverses; that is, surface waters again flow seaward (USGS, 3 updated, 26).

3.6.4 Hydrology: San Francisco Bay Basin

In the San Francisco Bay Basin, most precipitation comes as rainfall that flows directly to the Bay, with some loss due to infiltration, evapotranspiration, and storage in natural impoundments. The timing and volume of inflows to the Bay from local runoff, for the most part, follow closely after precipitation in the Bay Basin.

FIGURE 3.6.2.1-6 Map of the South Bay. The dashed line shows the 18 ft. depth contour.
(Source: Denton and Hunt, 1986)

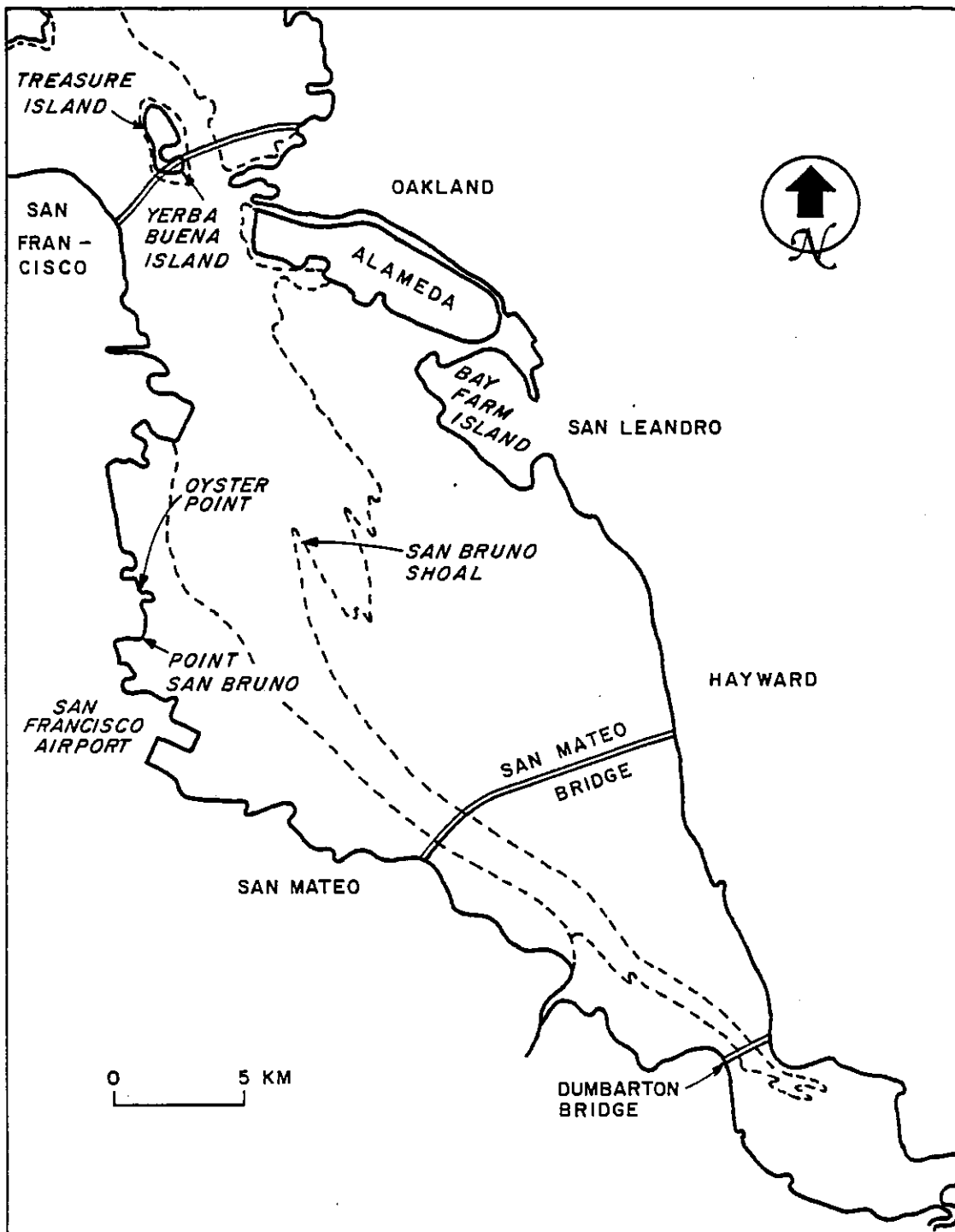

3.6.5 Unimpaired Flow Conditions: San Francisco Bay

Throughout this section, the San Francisco Bay and San Francisco Bay Basin are described separately. Before this section, both a river and its basin are considered together, as integral parts of an area's total description. This is not the case with the Bay and its Basin. Whereas the San Francisco Bay Basin may be compared with other basins, the San Francisco Bay (the equivalent of this Basin's river) cannot be meaningfully compared with any river in the Estuary. There have been no sizeable impoundments or diversions of San Francisco Bay waters. Unimpaired inflows to the Bay from the San Francisco Bay Basin are small when compared to the volume of tidal exchange (see Table 3.6.3.2-1, Figures 3.6.3.2-1 and -2). Existent tidal and seasonal flows from the Pacific Ocean, the Delta and the San Francisco Bay Basin therefore constitute the closest estimate of unimpaired flow conditions for the Bay.

3.6.6 Unimpaired Flow Conditions: San Francisco Bay Basin

The unimpaired runoff for separate hydrologic areas in the Bay Basin was simulated by SWRCB for the period of water years 1921 through 1978 (SWRCB,3,Appendix F). Unimpaired flow to the Bay Basin includes local inflows but does not include inflow from the Delta. Table 3.6.3.2-1 includes estimated monthly and annual runoff values for the years 1921 through 1978 (SWRCB,3,17 {revised 11/5/87}).

Figure 3.6.3.2-1 shows that average unimpaired Bay Basin local runoff is small, about 3.3 percent of average unimpaired Delta inflow to the Bay (SWRCB,3). When tidal exchanges are compared, local runoff becomes insignificant (DWR,662,1) (Figure 3.6.3.2-2). However, local inflow may have an effect on subregions within the Bay, such as the Suisun Marsh, the marshes around Cuttings Wharf west of Vallejo, and the Petaluma Creek discharge area.

3.6.7 Current Flow Conditions: San Francisco Bay

The considerations in 3.6.3.1 are also valid for current flow conditions in the Bay, with some exceptions. Upstream storage and regulated releases required by the Delta Plan, for instance, have provided higher levels of inflow from the Delta in the summer months of dry and critically dry years. Significant amounts of effluent from industrial and municipal sources are discharged into the Bay, but the total effects of these additional flows are not known.

3.6.8 Current Flow Conditions: San Francisco Bay Basin

A variety of factors—upstream reservoirs, the change in land use patterns from native vegetation to agricultural vegetation, impermeable surfaces such as concrete or asphalt, and the effects of ground water pumping—have altered the effects of Bay Basin local runoff. For example, the extensive expansion of

TABLE
3.6.3.2-1

SAN FRANCISCO BAY BASIN LOCAL INFLOW STUDY - UNIMPAIRED FLOW CONDITIONS
TOTAL MONTHLY LOCAL RUNOFF INTO SAN FRANCISCO BAY
SUMMATION OF MONTHLY LOCAL RUNOFF FROM FSA'S 90 - 96 (TAF)

| WATER YEAR | OCT | NOV | DEC | JAN | FEB | MAR | APR | MAY | JUN | JULY | AUG | SEP | AVERAGE MONTHLY | YEARLY TOTAL |
|------------|-------|-------|-------|-------|-------|-------|-------|------|------|------|-----|-----|-----------------|--------------|
| 21 | 2.4 | 14.9 | 356.7 | 378.1 | 127.7 | 68.1 | 83.8 | 20.2 | 8.0 | 2.7 | 2.8 | 0.9 | 88.8 | 1066.1 |
| 22 | 1.6 | 22.5 | 188.8 | 199.3 | 82.5 | 232.5 | 66.0 | 19.4 | 7.6 | 3.9 | 1.6 | 1.4 | 69.1 | 829.1 |
| 23 | 1.4 | 17.1 | 288.3 | 355.0 | 137.7 | 82.1 | 80.0 | 17.2 | 6.7 | 2.3 | 2.4 | 2.2 | 82.8 | 993.2 |
| 24 | 3.4 | 7.6 | 10.3 | 13.4 | 14.3 | 27.7 | 9.9 | 4.3 | 0.9 | 0.1 | 0.1 | 0.1 | 7.7 | 92.0 |
| 1925 | 5.4 | 228.0 | 241.8 | 375.4 | 124.8 | 401.1 | 195.9 | 25.6 | 10.1 | 5.3 | 3.0 | 2.7 | 134.9 | 1619.0 |
| 26 | 1.5 | 8.4 | 83.2 | 86.7 | 267.0 | 241.2 | 45.0 | 14.7 | 4.8 | 2.2 | 0.9 | 0.9 | 63.0 | 756.5 |
| 27 | 1.7 | 7.5 | 259.2 | 427.5 | 169.9 | 172.0 | 79.4 | 27.2 | 10.1 | 4.5 | 2.2 | 1.7 | 96.9 | 1163.0 |
| 28 | 2.5 | 2.8 | 82.5 | 81.4 | 210.7 | 197.2 | 36.6 | 15.5 | 5.6 | 2.8 | 1.2 | 0.9 | 53.3 | 641.8 |
| 29 | 1.1 | 1.9 | 5.1 | 88.8 | 42.8 | 78.3 | 27.1 | 11.9 | 2.0 | 0.5 | 0.3 | 0.5 | 21.8 | 261.2 |
| 1930 | 0.3 | 5.4 | 151.9 | 91.4 | 77.7 | 78.4 | 15.4 | 7.0 | 2.5 | 0.8 | 0.2 | 0.2 | 35.9 | 431.3 |
| 31 | 1.0 | 6.0 | 21.2 | 104.8 | 24.9 | 100.9 | 39.7 | 11.8 | 2.6 | 0.5 | 0.3 | 0.3 | 26.8 | 322.0 |
| 32 | 1.3 | 1.1 | 287.9 | 192.9 | 113.0 | 56.8 | 27.2 | 12.0 | 5.2 | 2.3 | 0.9 | 0.5 | 58.6 | 703.2 |
| 33 | 0.8 | 9.5 | 36.2 | 27.0 | 96.5 | 94.1 | 30.9 | 7.4 | 4.2 | 1.3 | 1.0 | 1.6 | 25.9 | 310.6 |
| 34 | 1.0 | 19.2 | 28.5 | 38.0 | 80.9 | 83.1 | 28.2 | 7.0 | 3.4 | 0.7 | 0.5 | 0.7 | 24.3 | 291.2 |
| 1935 | 2.0 | 32.4 | 128.5 | 499.6 | 152.0 | 173.2 | 62.3 | 21.4 | 8.7 | 4.2 | 2.0 | 1.5 | 90.7 | 1087.9 |
| 36 | 0.9 | 18.5 | 285.5 | 368.4 | 89.8 | 56.5 | 60.7 | 15.4 | 5.3 | 2.2 | 1.2 | 1.0 | 75.7 | 908.5 |
| 37 | 1.8 | 9.5 | 133.8 | 202.2 | 257.9 | 259.1 | 62.7 | 17.1 | 6.0 | 2.6 | 1.1 | 1.1 | 79.6 | 954.9 |
| 38 | 6.0 | 1.6 | 508.5 | 631.4 | 584.6 | 160.4 | 83.8 | 28.4 | 8.8 | 3.6 | 1.7 | 1.3 | 168.3 | 2020.0 |
| 39 | 9.5 | 13.9 | 18.8 | 18.4 | 24.0 | 23.4 | 23.5 | 7.7 | 2.5 | 0.1 | 0.0 | 0.6 | 11.9 | 142.5 |
| 1940 | 0.4 | 5.5 | 25.0 | 304.1 | 704.4 | 431.0 | 140.5 | 24.7 | 11.1 | 4.7 | 2.6 | 1.8 | 138.0 | 1655.6 |
| 41 | 0.9 | 4.8 | 387.8 | 718.7 | 572.4 | 366.1 | 416.9 | 56.2 | 16.4 | 7.3 | 5.0 | 4.0 | 213.0 | 2556.5 |
| 42 | 1.6 | 27.3 | 326.1 | 400.2 | 639.0 | 200.0 | 209.3 | 44.4 | 15.1 | 7.0 | 3.4 | 2.0 | 156.3 | 1875.6 |
| 43 | 1.9 | 19.0 | 111.5 | 464.8 | 167.0 | 140.9 | 41.2 | 19.7 | 8.2 | 4.2 | 1.9 | 1.0 | 81.8 | 981.4 |
| 44 | 0.8 | 5.7 | 14.9 | 28.2 | 183.2 | 212.2 | 26.7 | 14.2 | 7.2 | 2.6 | 1.2 | 0.5 | 41.5 | 497.6 |
| 1945 | 2.1 | 30.7 | 86.2 | 69.3 | 294.0 | 136.0 | 42.7 | 17.3 | 7.3 | 4.1 | 2.2 | 1.8 | 57.8 | 693.7 |
| 46 | 1.4 | 30.5 | 315.9 | 134.0 | 64.0 | 37.2 | 29.8 | 10.6 | 5.1 | 2.0 | 1.2 | 1.6 | 52.9 | 635.3 |
| 47 | 0.4 | 9.9 | 32.6 | 8.4 | 87.5 | 99.6 | 32.9 | 7.5 | 3.4 | 0.8 | 0.5 | 0.2 | 23.6 | 283.5 |
| 48 | 2.7 | 4.3 | 5.7 | 54.2 | 14.7 | 83.9 | 192.9 | 49.9 | 13.0 | 3.4 | 1.5 | 0.7 | 35.6 | 427.0 |
| 49 | 0.2 | 4.8 | 19.5 | 17.6 | 37.8 | 126.0 | 11.5 | 4.1 | 1.0 | 0.6 | 0.4 | 0.2 | 18.6 | 223.7 |
| 1950 | 1.9 | 1.8 | 2.3 | 117.8 | 215.7 | 55.1 | 30.0 | 10.1 | 3.9 | 0.9 | 0.6 | 0.3 | 36.7 | 440.5 |
| 51 | 1.9 | 113.4 | 407.7 | 376.8 | 219.1 | 172.2 | 41.4 | 23.6 | 8.1 | 3.9 | 2.0 | 1.4 | 114.3 | 1371.8 |
| 52 | 7.1 | 16.5 | 348.0 | 822.0 | 300.4 | 208.9 | 114.7 | 28.9 | 10.7 | 4.7 | 2.0 | 1.3 | 162.2 | 1946.1 |
| 53 | 1.2 | 2.6 | 323.9 | 438.0 | 43.8 | 82.4 | 40.2 | 25.1 | 9.1 | 3.2 | 1.6 | 1.1 | 81.7 | 980.2 |
| 54 | 0.9 | 5.4 | 4.7 | 114.9 | 135.5 | 93.0 | 75.3 | 10.6 | 3.3 | 1.0 | 0.6 | 1.6 | 37.3 | 447.7 |
| 1955 | 0.5 | 24.7 | 64.0 | 103.8 | 55.5 | 31.6 | 46.4 | 19.4 | 4.9 | 1.1 | 0.3 | 0.1 | 29.4 | 352.3 |
| 56 | 0.0 | 0.6 | 713.5 | 647.8 | 460.3 | 83.5 | 29.2 | 19.1 | 5.5 | 1.1 | 1.0 | 0.6 | 163.6 | 1963.4 |
| 57 | 5.5 | 5.4 | 4.9 | 26.7 | 195.1 | 118.7 | 33.6 | 61.8 | 13.1 | 2.3 | 0.7 | 0.5 | 39.0 | 468.4 |
| 58 | 13.7 | 8.9 | 54.4 | 276.0 | 910.2 | 424.0 | 570.9 | 35.1 | 14.6 | 5.6 | 2.2 | 1.2 | 193.1 | 2316.8 |
| 59 | 0.9 | 1.6 | 2.7 | 69.6 | 230.3 | 35.1 | 12.6 | 4.6 | 0.8 | 0.1 | 0.0 | 1.3 | 30.0 | 339.6 |
| 1960 | 0.3 | 0.4 | 1.4 | 16.6 | 222.5 | 85.8 | 18.0 | 6.5 | 1.8 | 0.4 | 0.1 | 0.2 | 29.5 | 354.1 |
| 61 | 0.4 | 6.8 | 22.5 | 64.9 | 128.4 | 99.3 | 34.7 | 11.5 | 3.3 | 0.5 | 0.3 | 0.4 | 31.1 | 373.0 |
| 62 | 0.1 | 3.1 | 19.2 | 17.6 | 312.3 | 149.3 | 18.7 | 6.2 | 1.7 | 0.6 | 0.4 | 0.1 | 44.1 | 529.4 |
| 63 | 234.5 | 13.5 | 111.9 | 364.3 | 411.4 | 171.6 | 369.3 | 54.2 | 16.7 | 5.7 | 3.8 | 2.3 | 146.6 | 1759.1 |
| 64 | 2.7 | 59.9 | 15.0 | 146.3 | 24.8 | 18.2 | 8.3 | 4.3 | 2.0 | 0.4 | 0.3 | 0.3 | 23.5 | 282.4 |
| 1965 | 1.0 | 20.0 | 420.6 | 453.8 | 51.0 | 31.0 | 112.6 | 20.6 | 7.6 | 3.1 | 3.2 | 1.3 | 93.8 | 1125.9 |
| 66 | 0.8 | 20.4 | 58.1 | 226.0 | 94.8 | 31.8 | 13.9 | 6.1 | 2.1 | 0.8 | 0.4 | 0.5 | 38.0 | 455.7 |
| 67 | 2.1 | 58.2 | 299.9 | 651.6 | 158.5 | 294.1 | 422.5 | 76.9 | 34.0 | 8.2 | 3.6 | 1.2 | 184.3 | 2211.8 |
| 68 | 1.5 | 2.5 | 17.2 | 150.8 | 141.9 | 119.7 | 20.5 | 6.8 | 2.1 | 0.7 | 0.9 | 0.8 | 38.9 | 466.4 |
| 69 | 1.4 | 4.6 | 126.9 | 648.9 | 544.1 | 174.0 | 51.5 | 16.8 | 8.0 | 3.1 | 3.0 | 2.5 | 132.1 | 1585.0 |
| 1970 | 3.5 | 3.2 | 170.6 | 712.7 | 119.2 | 101.3 | 15.3 | 7.4 | 4.1 | 2.3 | 1.4 | 1.1 | 95.2 | 1142.1 |
| 71 | 2.5 | 89.2 | 433.9 | 176.4 | 32.7 | 85.6 | 32.5 | 12.9 | 6.5 | 2.7 | 1.6 | 1.3 | 73.2 | 878.8 |
| 72 | 0.8 | 3.7 | 42.8 | 40.3 | 68.2 | 27.8 | 15.7 | 6.9 | 2.9 | 1.3 | 0.7 | 1.3 | 17.7 | 212.4 |
| 73 | 10.2 | 90.9 | 100.1 | 851.1 | 645.3 | 287.4 | 57.5 | 20.6 | 8.1 | 4.1 | 1.9 | 2.1 | 173.3 | 2079.3 |
| 74 | 8.1 | 247.2 | 251.3 | 368.2 | 104.7 | 450.4 | 223.1 | 29.2 | 11.9 | 6.7 | 4.1 | 3.6 | 142.4 | 1708.5 |
| 1975 | 5.1 | 4.1 | 11.9 | 16.5 | 270.6 | 339.5 | 80.0 | 20.7 | 7.3 | 4.0 | 2.0 | 1.7 | 63.6 | 763.4 |
| 76 | 10.8 | 14.1 | 12.0 | 12.2 | 13.7 | 21.9 | 21.6 | 7.0 | 1.4 | 0.1 | 0.1 | 0.5 | 9.7 | 116.2 |
| 77 | 2.1 | 7.1 | 10.3 | 16.0 | 17.0 | 31.8 | 7.8 | 4.3 | 0.8 | 0.1 | 0.0 | 0.0 | 8.2 | 98.5 |
| 78 | 0.3 | 31.7 | 133.9 | 863.9 | 470.9 | 391.7 | 117.6 | 35.8 | 12.0 | 4.7 | 2.7 | 3.1 | 172.6 | 2071.0 |



AVE 6.6 24.7 148.7 265.1 207.6 150.4 83.6 19.5 7.0 2.7 1.5 1.2 76.6 918.7
(SWRCB 3,27 Revised)

REVISED: 10-26-87

FIGURE 3.6.3.2-1

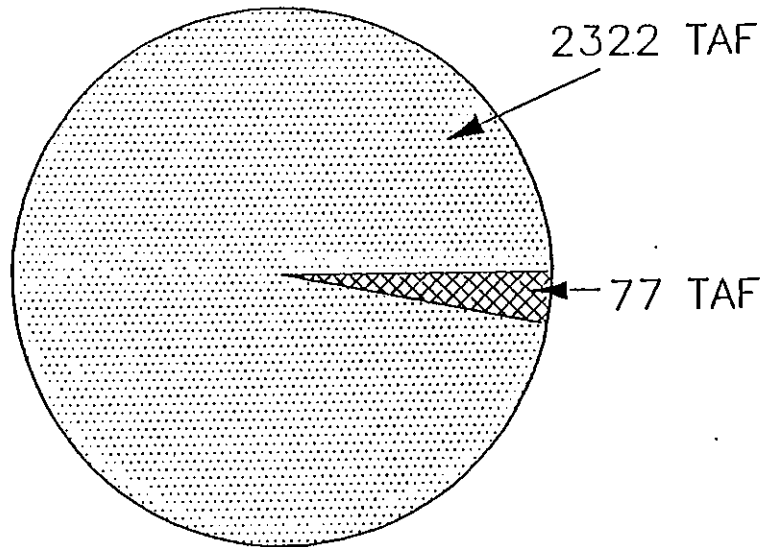
AVERAGE INFLOW FROM THE DELTA
COMPARED WITH
AVERAGE LOCAL BAY INFLOW



 AV INFLOW FROM DELTA
 AV LOCAL BAY INFLOW

(From SWRCB, 3)

FIGURE 3.6.3.2-2

GOLDEN GATE TIDAL EXCHANGE VOLUME
COMPARED WITH FRESHWATER INFLOW DURING A
FLOOD TIDE WITH A 24% TIDAL EXCHANGE RATIO

SUMMER CONDITIONS (6,200 cfs FRESHWATER INFLOW)

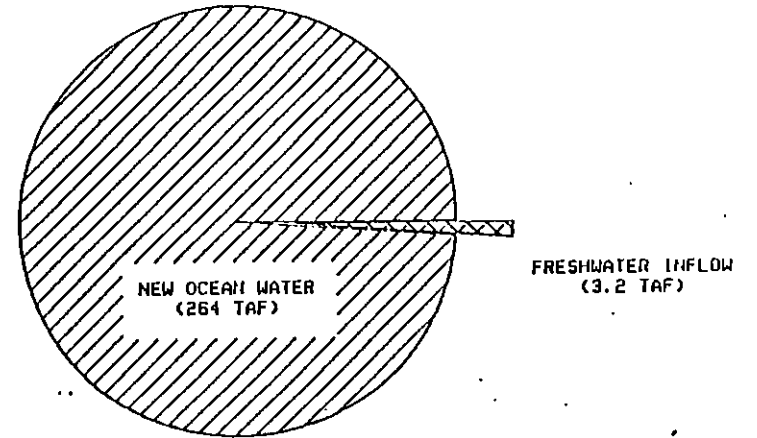

WINTER CONDITIONS (32,300 cfs FRESHWATER INFLOW)

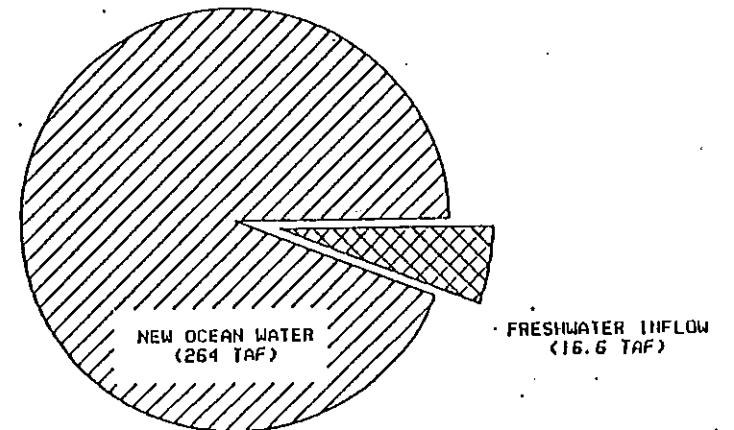

(DWR, 662)

3-63

CSPA-242

streets, parking lots and drainage conduits have caused less rainfall to reach ground water and subsequently greater amounts to flow directly into the Bay. Wastewater treatment plant discharges and water imports into the Bay Basin have also changed the locations and greatly increased the quantity of local inflows to the Bay.

*significance
of wastewater
discharge
in Bay
flows*

DWR developed a local runoff survey for separate Bay Basin hydrologic areas (Table 3.6.4.2-1) and a summary of wastewater discharge for the period of water years 1970 through 1982 (Table 3.6.4.2-2)(SWRCB,3,Appendix R). Listing the monthly, and yearly runoff totals, the tables indicate that effluent discharge can be as much as 70 percent less than local runoff (WY 81-82) and as much as 25 percent more (WY 76-77). Table 3.6.4.2-3 compares unimpaired and current flow conditions in the San Francisco Bay Basin.

TABLE 3.6.4.2-3
SAN FRANCISCO BAY BASIN:
UNIMPAIRED FLOW AND CURRENT FLOW CONDITIONS
BY WATER YEAR TYPE^{1/}

| Water Year Type | Unimpaired Flow (TAF) | | Current Flow | |
|-----------------|-----------------------|--------|---------------------|-------|
| | Low | High | Low | High |
| Wet | 427.0 | 2556.5 | 157.2 | 301.3 |
| Above Normal | 440.5 | 2071.0 | 194.9 ^{2/} | |
| Below Normal | 212.4 | 1079.3 | 112.3 | 231.6 |
| Dry | 261.2 | 1142.1 | 191.0 ^{3/} | |
| Critical | 92.0 | 322 | 84.1 | 126.8 |

- 1/ Individual water years measured as percentages of the Sacramento Basin's Four River Index (see Chapter 4) have been used, resulting in some overlap of flow amounts for different water year types. Flows do not include inflows from the Delta.
- 2/ Only one reference point, Water Year 1969-70.
- 3/ Only one reference point, Water Year 1977-78

TABLE 3.6.4.2-1
SAN FRANCISCO BAY AREA LOCAL RUNOFF

(SUM OF DRAINAGE STUDY AREAS (DSA) 90 ----> 96) LESS (SUM OF DSAs 90 ----> 96) EFFLUENT DISCHARGE (ED) (TAF)

| WTR YEAR | OCT | NOV | DEC | JAN | FEB | MAR | APR | MAY | JUN | JUL | AUG | SEP | TOTAL | AVG MO |
|----------|-----|-----|-----|-----|-----|-----|-----|-----|-----|-----|-----|-----|-------|--------|
| 6970 | 51 | 46 | 187 | 724 | 145 | 161 | 55 | 48 | 43 | 43 | 42 | 39 | 1584 | 132 |
| 7071 | 44 | 130 | 385 | 148 | 61 | 106 | 65 | 50 | 42 | 42 | 42 | 40 | 1155 | 96 |
| 7172 | 40 | 45 | 85 | 65 | 77 | 52 | 50 | 44 | 41 | 42 | 42 | 42 | 627 | 52 |
| 7273 | 64 | 132 | 100 | 595 | 506 | 264 | 85 | 63 | 55 | 47 | 45 | 44 | 2000 | 167 |
| 7374 | 52 | 225 | 229 | 322 | 112 | 387 | 247 | 63 | 50 | 49 | 45 | 43 | 1824 | 152 |
| 7475 | 46 | 44 | 58 | 59 | 277 | 347 | 104 | 55 | 44 | 43 | 43 | 41 | 1161 | 97 |
| 7576 | 52 | 43 | 44 | 41 | 44 | 50 | 43 | 39 | 37 | 38 | 40 | 38 | 509 | 42 |
| 7677 | 40 | 41 | 44 | 42 | 32 | 42 | 32 | 34 | 31 | 33 | 33 | 33 | 438 | 36 |
| 7778 | 32 | 63 | 113 | 517 | 294 | 301 | 130 | 53 | 42 | 41 | 41 | 40 | 1665 | 139 |
| 7879 | 41 | 46 | 43 | 187 | 225 | 124 | 66 | 50 | 40 | 40 | 40 | 39 | 942 | 78 |
| 7980 | 51 | 57 | 139 | 406 | 627 | 189 | 83 | 55 | 44 | 44 | 44 | 41 | 1780 | 148 |
| 8081 | 45 | 42 | 65 | 159 | 73 | 130 | 56 | 47 | 43 | 43 | 42 | 41 | 786 | 66 |
| 8182 | 51 | 171 | 370 | 584 | 330 | 385 | 659 | 73 | 54 | 49 | 46 | 47 | 2821 | 235 |
| NO AVG | 47 | 83 | 143 | 296 | 216 | 195 | 129 | 52 | 44 | 43 | 42 | 41 | 1330 | 111 |

(SUM OF DSAs 90 ----> 96) LESS (SUM OF DSAs 90 ----> 96) ED (CFS)

| WTR YEAR | OCT | NOV | DEC | JAN | FEB | MAR | APR | MAY | JUN | JUL | AUG | SEP | TOTAL | AVG MO |
|----------|------|------|------|-------|-------|------|-------|------|-----|-----|-----|-----|-------|--------|
| 6970 | 825 | 767 | 3035 | 11777 | 2614 | 2619 | 917 | 777 | 726 | 698 | 687 | 661 | 26102 | 2175 |
| 7071 | 711 | 2183 | 6257 | 2403 | 1102 | 1730 | 1093 | 809 | 710 | 688 | 686 | 665 | 19038 | 1587 |
| 7172 | 656 | 761 | 1388 | 1050 | 1338 | 847 | 844 | 715 | 690 | 687 | 685 | 713 | 10374 | 864 |
| 7273 | 1038 | 2215 | 1629 | 9683 | 9105 | 4300 | 1421 | 1026 | 919 | 757 | 732 | 746 | 33570 | 2798 |
| 7374 | 841 | 3782 | 3725 | 5238 | 2010 | 6293 | 4144 | 1032 | 835 | 801 | 737 | 722 | 30157 | 2513 |
| 7475 | 747 | 744 | 941 | 961 | 4989 | 5645 | 1748 | 900 | 744 | 700 | 691 | 683 | 19493 | 1624 |
| 7576 | 843 | 719 | 712 | 666 | 765 | 819 | 729 | 633 | 624 | 615 | 650 | 643 | 8417 | 701 |
| 7677 | 655 | 682 | 718 | 686 | 584 | 681 | 544 | 554 | 529 | 531 | 532 | 554 | 7252 | 604 |
| 7778 | 528 | 1051 | 1841 | 8402 | 5292 | 4890 | 2178 | 857 | 706 | 670 | 661 | 664 | 27739 | 2312 |
| 7879 | 661 | 778 | 699 | 3037 | 4057 | 2023 | 1102 | 816 | 676 | 658 | 650 | 650 | 15806 | 1317 |
| 7980 | 822 | 963 | 2266 | 6596 | 10895 | 3073 | 1398 | 895 | 743 | 719 | 712 | 692 | 29774 | 2481 |
| 8081 | 726 | 709 | 1053 | 2586 | 1311 | 2114 | 941 | 763 | 729 | 695 | 688 | 694 | 13010 | 1084 |
| 8182 | 835 | 2882 | 6024 | 9489 | 5934 | 6268 | 11080 | 1190 | 906 | 799 | 752 | 789 | 46949 | 3912 |
| NO AVG | 760 | 1403 | 2330 | 4813 | 3846 | 3177 | 2165 | 844 | 734 | 694 | 682 | 683 | 22129 | 1844 |

(SWCRB,3,APPENDIX R,pg. 17)

TABLE 3.6.4.2-2

SAN FRANCISCO BAY AREA LOCAL RUNOFF

EFFLUENT DISCHARGE (ED) FOR DRAINAGE STUDY AREA (DSA) 90 ----> 96 (MGD)

| WTR YEAR | 90 & 91 | 92 N | 92 S | 92 | 93 | 94 | 95 | 96 | TOTAL | AVG MO |
|----------|---------|------|------|-------|------|-------|------|-------|-------|--------|
| 6970 | 93.0 | 28.2 | 79.6 | 107.8 | 33.5 | 120.9 | 51.2 | 116.4 | 630.6 | 52.6 |
| 7071 | 93.0 | 29.2 | 84.3 | 113.5 | 30.1 | 109.0 | 51.6 | 124.1 | 634.8 | 52.9 |
| 7172 | 89.2 | 30.2 | 82.7 | 112.9 | 29.6 | 114.5 | 52.0 | 135.3 | 646.4 | 53.9 |
| 7273 | 91.8 | 31.9 | 88.0 | 119.9 | 29.6 | 136.0 | 52.0 | 141.3 | 690.5 | 57.5 |
| 7374 | 89.5 | 28.7 | 83.7 | 112.4 | 26.9 | 129.9 | 47.6 | 140.0 | 658.7 | 54.9 |
| 7475 | 87.1 | 27.0 | 83.7 | 110.7 | 26.4 | 112.2 | 48.9 | 147.7 | 643.7 | 53.6 |
| 7576 | 66.6 | 24.0 | 73.4 | 97.4 | 24.8 | 104.5 | 42.4 | 147.4 | 580.5 | 48.4 |
| 7677 | 60.3 | 22.1 | 63.2 | 85.3 | 24.7 | 95.8 | 36.1 | 126.3 | 513.8 | 42.8 |
| 7778 | 68.1 | 25.3 | 68.5 | 93.8 | 27.0 | 110.6 | 41.8 | 162.5 | 597.6 | 49.8 |
| 7879 | 76.6 | 30.5 | 71.7 | 102.2 | 27.2 | 103.7 | 46.4 | 158.9 | 617.2 | 51.4 |
| 7980 | 79.0 | 34.7 | 75.2 | 109.9 | 27.7 | 116.2 | 45.0 | 163.8 | 651.5 | 54.3 |
| 8081 | 76.2 | 33.9 | 71.0 | 104.9 | 36.3 | 117.7 | 59.3 | 150.7 | 650.0 | 54.2 |
| 8182 | 98.5 | 39.1 | 81.5 | 120.6 | 42.9 | 140.8 | 30.4 | 154.6 | 708.4 | 59.0 |
| AREA AVG | 82.2 | 29.6 | 77.4 | 107.0 | 29.7 | 116.3 | 46.5 | 143.8 | 632.6 | 52.7 |

ED FOR DSAs 90 ----> 96 (CFS)

| WTR YEAR | 90 & 91 | 92 N | 92 S | 92 | 93 | 94 | 95 | 96 | TOTAL | AVG MO |
|----------|---------|------|-------|-------|------|-------|------|-------|--------|--------|
| 6970 | 144.2 | 43.7 | 123.4 | 167.1 | 51.9 | 187.4 | 79.4 | 180.4 | 977.4 | 81.5 |
| 7071 | 144.2 | 45.3 | 130.7 | 175.9 | 46.7 | 169.0 | 80.0 | 192.4 | 983.9 | 82.0 |
| 7172 | 138.3 | 46.8 | 128.2 | 175.0 | 45.9 | 177.5 | 80.6 | 209.7 | 1001.9 | 83.5 |
| 7273 | 142.3 | 49.4 | 136.4 | 185.8 | 45.9 | 210.8 | 80.6 | 219.0 | 1070.3 | 89.2 |
| 7374 | 138.7 | 44.5 | 129.7 | 174.2 | 41.7 | 201.3 | 73.8 | 217.0 | 1021.0 | 85.1 |
| 7475 | 135.0 | 41.9 | 129.7 | 171.6 | 40.9 | 173.9 | 75.8 | 228.9 | 997.7 | 83.1 |
| 7576 | 103.2 | 37.2 | 113.8 | 151.0 | 38.4 | 162.0 | 65.7 | 228.5 | 899.8 | 75.0 |
| 7677 | 93.5 | 34.3 | 98.0 | 132.2 | 38.3 | 148.5 | 56.0 | 195.8 | 796.4 | 66.4 |
| 7778 | 105.6 | 39.2 | 106.2 | 145.4 | 41.9 | 171.4 | 64.8 | 251.9 | 926.3 | 77.2 |
| 7879 | 118.7 | 47.3 | 111.1 | 158.4 | 42.2 | 160.7 | 71.9 | 246.3 | 956.7 | 79.7 |
| 7980 | 122.5 | 53.8 | 116.6 | 170.3 | 42.9 | 180.1 | 69.8 | 253.9 | 1009.8 | 84.2 |
| 8081 | 118.1 | 52.5 | 110.1 | 162.6 | 56.3 | 182.4 | 91.9 | 233.6 | 1007.5 | 84.0 |
| 8182 | 152.7 | 60.6 | 126.3 | 186.9 | 66.5 | 218.2 | 47.1 | 239.6 | 1098.0 | 91.5 |
| AREA AVG | 127.4 | 45.9 | 120.0 | 165.9 | 46.1 | 180.3 | 72.1 | 222.8 | 980.5 | 81.7 |

ED FOR DSAs 90 ----> 96 (TAF)

| WTR YEAR | 90 & 91 | 92 N | 92 S | 92 | 93 | 94 | 95 | 96 | TOTAL | AVG MO |
|----------|---------|------|------|-------|------|-------|------|-------|-------|--------|
| 6970 | 104.4 | 31.7 | 89.3 | 121.0 | 37.6 | 135.7 | 57.5 | 130.6 | 707.8 | 59.0 |
| 7071 | 104.4 | 32.8 | 94.6 | 127.4 | 33.8 | 122.3 | 57.9 | 139.3 | 712.5 | 59.4 |
| 7172 | 99.8 | 33.8 | 92.6 | 126.4 | 33.1 | 128.1 | 58.2 | 151.4 | 723.4 | 60.3 |
| 7273 | 103.0 | 35.8 | 98.8 | 134.6 | 33.2 | 152.6 | 58.4 | 158.6 | 775.0 | 64.6 |
| 7374 | 100.5 | 32.2 | 93.9 | 126.2 | 30.2 | 145.8 | 53.4 | 157.1 | 739.3 | 61.6 |
| 7475 | 97.8 | 30.3 | 93.9 | 124.2 | 29.6 | 125.9 | 54.9 | 165.8 | 722.5 | 60.2 |
| 7576 | 74.5 | 26.9 | 82.1 | 109.0 | 27.8 | 116.9 | 47.5 | 165.0 | 649.7 | 54.1 |
| 7677 | 67.7 | 24.8 | 70.9 | 95.7 | 27.7 | 107.5 | 40.5 | 141.8 | 576.7 | 48.1 |
| 7778 | 76.4 | 28.4 | 76.9 | 105.3 | 30.3 | 124.1 | 46.9 | 182.4 | 670.7 | 55.9 |
| 7879 | 86.0 | 34.2 | 80.5 | 114.7 | 30.5 | 116.4 | 52.1 | 178.3 | 692.7 | 57.7 |
| 7980 | 88.4 | 38.8 | 84.2 | 123.0 | 31.0 | 130.0 | 50.4 | 183.3 | 729.1 | 60.8 |
| 8081 | 85.5 | 38.0 | 79.7 | 117.7 | 40.7 | 132.1 | 66.6 | 169.1 | 729.5 | 60.8 |
| 8182 | 110.6 | 43.9 | 91.5 | 135.4 | 48.1 | 158.0 | 34.1 | 173.5 | 795.1 | 66.3 |
| AREA AVG | 92.2 | 33.2 | 86.8 | 120.0 | 33.4 | 130.4 | 52.2 | 161.3 | 709.5 | 59.1 |

(SWCRB,3,Appendix R,pg. 14)

References for Chapter 3.0

- BCDC.1982. Diked Historic Baylands of San Francisco Bay. Findings, Policies, and Maps. Adopted October 21, 1982.
- RWQCB 2.1975. Water Quality Control Plan Report, San Francisco Bay Basin (2). Part II, April 1975.
- RWQCB 5.1975. Water Quality Control Plan Report, Sacramento River Basin (5A), Sacramento-San Joaquin Delta Basin (5B), San Joaquin Basin (5C). Volume II. 1906 through 1920--DWR Division of Planning Statewide Planning Branch, 4/14/80; 1921 through 1978--DWR Exhibit 7, except as stated below;

1969 through 1983 Sacramento River near Red Bluff--DWR California Data Exchange Center, 1/15/88; 1984 through 1987--DWR California Data Exchange Center, 1/15/88
- Cheng, T.T., and Gardner, J.W., Tides, Tidal and Residual Currents in San Francisco Bay, 1979-1980, ^{USGS} ~~USGS~~ Water Resources Investigation Report 84-4339, February 1984.
- Denton, R.A., and Hunt, J.R., Currents in San Francisco Bay--Final Report, SWRCB Publication No. 86-7wr, March 1986.
- SWRCB, Final Environmental Impact Report for the Water Quality Control Plan and Water Right Decision, Sacramento-San Joaquin Delta and Suisun Marsh, August 1978.
- Orlob, G.T. 1982. "Without Project" Water Quality. Memorandum from Dr. G.T. Orlob of G.T. Orlob and Associates to Diverters, South Delta Water Agency on February 10, 1982.



4.0 BENEFICIAL USES OF BAY-DELTA ESTUARY WATER

4.1 Introduction

"Beneficial uses' of the waters of the state that may be protected against quality degradation include, but are not necessarily limited to, domestic, municipal, agricultural and industrial supply; power generation; recreation; esthetic enjoyment; navigation; and preservation and enhancement of fish, wildlife, and other aquatic resources or preserves" (Porter-Cologne Water Quality Control Act, Water Code Section 13050(f)).

The establishment of beneficial uses of waters of the state is the first task of water quality control planning. Only after beneficial uses have been properly identified can appropriate water quality objectives and other control policies be established. A clear understanding of the service each beneficial use provides to the citizens of California also builds a foundation for weighing and balancing the levels of protection needed. In summarizing issues addressed during Phase I of the Bay-Delta hearing, this chapter discusses the beneficial uses, their water requirements, their salt tolerance, and, when available, their economic value.

4.2 Estuary Water for Municipal and Domestic Supply Purposes

Municipal and Domestic Supply (MUN) includes established uses in community or military water systems as well as domestic uses from private systems (RWQCB, 1975). Common domestic uses of water include those for sanitation, direct consumption, food preparation, landscape watering, among others (RWQCB, 1975). Common municipal uses of water include those for light commercial businesses, restaurants, parks, etc. The two MUN needs are continuous and require a dependable water supply (SWC, 3, 1). It is state policy that domestic use is the highest use of water (Water Code {WC} Section 106).

Delta surface waters are used to supply MUN needs in both northern and southern California. The quality of these waters, and therefore MUN supplies, depends on complex flow and salinity relationships within the Estuary. When Delta outflow is insufficient to move the salinity gradient west of Chipps Island, there is a potential for ocean salinity to be drawn into the Delta's interior if reverse flows also occur (see 3.5.2.4). Saline waters may subsequently degrade supplies taken through the intakes of the Contra Costa Canal and Clifton Court (DWR, 51D).

Locations of historic MUN use remain much the same, although there has been a change in the season and length of time that acceptable water occurs. Historically, to mitigate adverse salinity conditions prior to the existence of the state and federal projects, municipalities would fill storage reservoirs, "...when the water in the (San Joaquin River) was fresh to provide a supply to meet the demands during the period of saline invasion..." (DWR, 1931). Prior to 1920, in the western Delta the MUN water source for Antioch became "...unfit for domestic consumption during part of the late summer or early fall months of most years and certainly during dry years as far back as the (eighteen) sixties and

seventies." (DWR, 1931). By 1920 Antioch had a significant decrease in the period of availability of municipal water supply from the San Joaquin River. Generally, as upstream development increased, the position of the salinity gradient moved upstream. In most areas in the Delta, operations of the federal and state water projects reversed this degradation by providing additional, sustained amounts of water during the summer months and prolonged dry periods (T, XIII, 151:5-21; DWR, 84-87).

Present and projected MUN water use of Delta surface water is presented in Table 4.2-1. Delta cities that rely on this water are Antioch, Pittsburg, Tracy and Oakley. Pittsburg and Oakley obtain water supplies from Rock Slough via the Contra Costa Canal; Tracy obtains its supply from Old River via the Delta-Mendota Canal. Antioch diverts part of its water supply directly from the San Joaquin River and obtains part from the Contra Costa Canal. Sacramento maintains a standby diversion facility on the Sacramento River in the Upper Delta, but normally diverts from two other facilities on the American and Sacramento rivers upstream of the Delta. The cities of Stockton, Tracy, Rio Vista, and other Delta communities rely to various degrees on ground water for MUN water supplies (SWRCB, 1978).

TABLE 4.2-1
MAJOR MUNICIPAL WATER DEMANDS

| | <u>Current 1986 Population</u> | <u>Current 1986 Water Demands (AF)</u> |
|--------------------|------------------------------------|--|
| City of Tracy | 25,300 ^{1/} | 7,822 ^{2/} |
| Antioch | 40,734 ^{3/} | 9,073 ^{4/} (1985) |
| Pittsburg | 53,125 ^{3/} | 7,729 ^{4/} (1985) |
| Oakley County W.D. | 8,436 ^{3/} | 2,128 ^{4/} (1985) |
| | <u>Year 2000 Population</u> | <u>Year 2000 Water Demands (AF)</u> |
| City of Tracy | 33,000 ^{1/} (1990) | 10,400 ^{2/} (1990) |
| Antioch | 78,900 ^{5/} | 14,338 ^{4/} |
| Pittsburg | 59,100 ^{5/} | 12,994 ^{4/} |
| Oakley County W.D. | N/A | 5,153 ^{4/} |

-
- 1/ City of Tracy (CT), Exhibit No. 2
 2/ CT, Exhibit No. 3
 3/ Contra Costa Water District (CCWD), Exhibit No. 7
 4/ CCWD, Exhibit No. 25
 5/ CCWD, Exhibit No. 24

4.3 Industrial Beneficial Uses

4.3.1 Industrial Use Comprises Three Separate Beneficial Uses:

- Industrial Service Supply (IND) "includes uses which do not depend primarily on water quality such as mining, cooling water supply, hydraulic conveyance, gravel washing, fire protection, and oil well repressurization".
- Industrial Process Supply (PROC) "includes process water supply and all uses related to the manufacturing of products".
- Hydroelectric Power Generation (POW) "is that supply used for hydropower generation" (RWQCB, 5, 1975).

Very little information on Bay-Delta industrial use was presented in Phase I of the hearing. Two Bay-Delta industries, Fibreboard and Shell Oil Company, presented testimony, but no exhibits. Contra Costa Water District (CCWD) and DWR presented exhibits and testimony, but of a limited scope. SWRCB presented the "Environmental Impact Report for the Water Quality Control Plan and Water Right Decision, Sacramento-San Joaquin Delta and Suisun Marsh" (D-1485 EIR). This document was prepared for the D-1485 hearings and contains more extensive, but possibly out-of-date information on Bay-Delta industrial use.

out of date? data?

Water use in 1975 of 11 major industries using at least 50,000 gallons per day is summarized in Table 4.3-1. Water delivered from the Contra Costa Canal to major industrial water users in the Delta totaled 22,733 acre-feet in 1985 and 15,519 acre-feet in 1986 (CCWD, 26).

4.3.2 Antioch-Pittsburg Area

Most of the industries that depend upon Bay-Delta surface waters are in the Antioch-Pittsburg area. These industries depend almost exclusively for their water supplies on three possible sources:

- Water pumped by the industries directly from the San Joaquin River or New York Slough.
- Untreated water purchased from CCWD and conveyed from Rock Slough via the Contra Costa Canal or, in the Pittsburg area, pumped from Mallard Slough at the District's pumping plant.
- Treated water purchased from municipal purveyors who obtain their water from the Contra Costa Canal or, in the case of Antioch, from either Contra Costa Canal or a San Joaquin River diversion.

The Pacific Gas and Electric Company (PG&E) powerplants at both Antioch and Pittsburg use large quantities of water for once-through cooling. These uses are not affected substantially by salinity changes. PG&E did not provide information concerning Bay-Delta industrial water use in Phase I of the hearing, nor did they participate in the D-1485 hearing.

Table 4.3-1
Industrial Water Use Summary - 1975
(acre-feet per year)

| Industrial Water User | Location | Product | Water Use | Water Source | | | | Total |
|--|-----------|---|-----------|---------------------|--------------|-------------|------------------|------------------|
| | | | | Offshore Diversions | Ground Water | Costa Canal | Municipal Supply | |
| Crown Zellerbach Antioch (Now Gaylord Containers Inc.) | Antioch | Pulp and Paper Products | Boiler | (230)* | | (90) | (40) | 360 |
| | | | Cooling | (620) | | | | 620 |
| | | | Process | (11,000) | | | | 11,000 |
| | | | Total | 11,850 | 0 | 90 | 40 | 11,980 |
| | | | | | | | | 17,422 (1986) a/ |
| E.I DuPont | Oakley | Pigments, Petrochemicals, Fluorocarbons | Boiler | | | | 420 | 420 |
| | | | Cooling | | | | 240 | 240 |
| | | | Process | | | | 1,420 | 1,420 |
| | | | Total | 0 | 0 | 0 | 2,080 | 2,080 |
| Fibreboard | Antioch | Pulp and Paper Products | Boiler | | (780) | (230) | | 1,010 |
| | | | Cooling | (1,770) | | | | 1,770 |
| | | | Process | (14,020) | | (320) | | 14,340 |
| | | | Total | 13,783 (1986) b/ | 780 | 550 | 0 | 17,120 |
| Hickmott Canning | Antioch | Tomato Products | Boiler | | | | 560 | 560 |
| | | | Cooling | | | | 560 | 560 |
| | | | Process | | | | 1,120 | 1,120 |
| | | | Total | 0 | 0 | 0 | 1,120 | 1,120 |
| Kaiser Gypsum | Antioch | Wallboard | Boiler | | | | (75) | 75 |
| | | | Cooling | | | | (75) | 75 |
| | | | Process | | | | 150 | 150 |
| | | | Total | 0 | 0 | 0 | 150 | 150 |
| PG&E | Antioch | Electric Power | Boiler | | | | | |
| | | | Cooling | 1,106,000 | | | | |
| | | | Process | | | | | |
| | | | Total | 1,106,000 | 0 | 0 | 0 | 1,106,000 |
| Collier Carbon and Chemical | Pittsburg | Ammonium Phosphate Fertilizers | Boiler | | | 25 | | 50 |
| | | | Cooling | 25 | | 60 | | 60 |
| | | | Process | | | 85 | | 110 |
| | | | Total | 25 | 0 | 85 | 0 | 110 |
| Dow Chemical | Pittsburg | Commercial Chemicals | Boiler | | | (1,300) | | 1,300 |
| | | | Cooling | (1,310) | | | | 1,310 |
| | | | Process | (1,110) | | (200) | | 1,310 |
| | | | Total | 2,420 | 0 | 1,500 | 0 | 3,920 |
| Johns-Manville | Pittsburg | Roofing Paper | Boiler | | | | 40 | 40 |
| | | | Cooling | 190 | | | | 190 |
| | | | Process | 150 | | | 100 | 250 |
| | | | Total | 340 | 0 | 0 | 140 | 480 |
| PG&E | Pittsburg | Electric | Boiler | | | | | |
| | | | Cooling | 708,000 | | | | |
| | | | Process | | | | | |
| | | | Total | 708,000 | 0 | 0 | 0 | 708,000 |
| U.S. Steel | Pittsburg | Steel Products | Boiler | | | (10,000) | | 10,000 |
| | | | Cooling | | | | (1,500) | 1,500 |
| | | | Process | | | | 1,500 | 1,500 |
| | | | Total | 0 | 0 | 10,000 | 1,500 | 11,500 |

a) DWR, 204

b) Ibid.

*Note: Parentheses indicate assumed breakdown of water use where industry could not furnish these data.

Source: Environmental Impact Report for the Water Quality Control Plan, August 1978 and Water Decision, Sacto-SanJoaquin Delta & Suisun Marsh, pg. 111-149.

4.3.3 Other Industries

Other Bay-Delta industries located outside the Antioch-Pittsburg area include: Shell Oil Company in Martinez which obtains most of its water supply from the Contra Costa Canal (T,IX,41:11-14); and three industries near Tracy, H. J. Heinz Company, Laprino Cheese and Laura Scudders, which obtain their water supply from the DMC or local ground water supplies (T,IX,11:4-12;T,IX,21:21-25). *Shell* *Heinz*

Gaylord Containers Corporation recycles wastepaper at a mill on the south shore of the San Joaquin River. In 1975, approximately 12.5 million gallons per day (MGD) of water pumped directly from the San Joaquin River or purchased from CCWD were required for processing and cooling in the manufacture of several grades of paper that are converted into corrugated boxes, paper towels, etc. *Gaylord Containers*

Because canned goods can corrode when left in contact with linerboard of corrugated boxes containing more than 500 ppm sodium chloride, process water for the manufacture of boxes is kept below 150 ppm chloride (T,VI,92:25-93:6).

Fibreboard Louisiana-Pacific, a large kraft paper mill located on the south shore of the San Joaquin River approximately five miles east of Antioch, produces linerboard, corrugating medium, and fiber board from wood chips (hearing for D-1485, RT, Vol. XVII, p. 135). Unlike the nearby Gaylord Container Mill, Fibreboard's predominant raw material is pulp produced from wood chips. Fibreboard presented the only evidence supporting the need for process water with not more than 150 ppm chloride for the production of linerboard (T,IV,92:25-93:6;T,IX75:23,81:23). A witness for Contra Costa Water District, however, stated that a standard of 250 ppm chloride year-round would be adequate (T,VII,97:22,25). *Lou-Pacific*

Fibreboard has two main sources of water, direct pumping from the San Joaquin River and CCWD. When the chlorinity in the San Joaquin River supply is higher than 150 ppm, a partial supply of water is purchased from CCWD; when the chlorinity level reaches 250 ppm, the entire supply is taken from the Contra Costa Canal (T,IX,77:23-78:6). A third, relatively minor source is ground water from two wells that provide between 500,000 and 800,000 gallons per day. *Fibreboard*

Dow Chemical Company did not present information on current water requirements during the hearing, but information was introduced in the D-1485 EIR. The Dow Chemical plant, located on New York Slough between the cities of Antioch and Pittsburg, diverts from New York Slough for cooling and process waters (hearing for D-1485, citing Decision 1379, RT Vol. XXXI, pp. 3292-3371; Dow Exhibit 502). An alternate water supply from the Contra Costa Canal was available for "critical water use" when the offshore supply exceeded a chloride concentration of 160 ppm. *Dow*

U.S. Steel

U.S. Steel presented testimony in 1970 regarding water use at its steel processing facilities located on the south shore of New York Slough between Pittsburg and Antioch (hearing for D-1485, pg. III-160). Water was diverted from New York Slough for cooling uses and, seasonally, for process water in the Wire Mill. Contra Costa Canal water was used for process water in the Sheet and Tin Mill, the Morgan Rod Mill, the Pipe Mill, and for boiler feed water supply (hearing preceding D-1485; hearing preceding Decision 1379, RT, Vol. XXX, pp. 3175-3246). Table 4.3-1 shows that in 1975 U.S. Steel used 11,500 acre-feet of water from the Contra Costa Canal and city supplies.

Johns-Manville

Johns-Manville Products Corporation presented testimony in 1970 concerning water use at its plant located on New York Slough in the City of Pittsburg (hearing for D-1485, citing Decision 1379, RT Vol. 28, pp. 3098-3140). New York Slough provided the entire water supply until chlorinity limits were reached, at which point an alternate supply purchased from the City of Pittsburg was then used for the boiler feed water and paper mill (see Table 4.3-1).

Shell Oil Company operates an oil refinery on the south bank of Suisun Bay near Martinez, next to the Benicia Bridge. Though no water is incorporated directly in the refineries products, water is important in the refining process. Large quantities are used for cooling, steam generation, pumps and compressors, and to heat refining processes (T,IX,42:15-19). The refinery's main products are approximately five million gallons per day of gasoline, jet and diesel fuel (T,IX,41:22-25). The facility has 850 company employees and 300 contract employees, with a current annual company payroll of \$38 million, and an annual contract payroll of \$18 million (T,IX,42:3-5).

Shell Oil Company's source of water supply is the Contra Costa Canal terminating in Martinez. Annual water consumption in 1986 was approximately 10,000 acre-feet, with an average consumption rate of approximately 6,200 gallons per minute (gpm) and a peak consumption rate of approximately 9,060 gpm. Of the average use rate of 6,200 gpm, about 2,500 gpm is used for preparing boiler feed water, and 3,000 gpm for cooling water. The balance is used for pad and equipment washdown, landscape irrigation and other miscellaneous uses (T,IX,42:20-25;T,IX,43:1-10). Shell Oil Company's major concern is the reliability of their water supply (T,IX,46:12-13).

4.4 Estuary Agriculture Beneficial Uses

4.4.1 Delta Agriculture

Delta Agriculture

About three-quarters of the Delta land area (515,000 acres) is farmed with water from the channels and sloughs adjacent to each individual island in the Delta (DWR,304). There is not a water supply problem in the agricultural waters affected by tidal actions. Most channels in the Delta have sufficient volume to supply agricultural water needs even at low tidal stages. However, water levels in some isolated channels in the southern Delta are affected by drawdown caused by the state and federal pumping plants (T,XIII,230:17-233:10).

Soils in the Delta fall generally into two categories, organic and mineral. Farmed organic soils constitute 68 percent of the total cropped area and mineral soils the remaining 32 percent. Organic soils are usually found in the Delta lowlands, that is, the land area below an elevation of +5 feet mean sea level. Delta uplands are those areas above +5 feet mean sea level. Mineral soils are found in both the Delta lowlands and uplands.

4.4.1.1 Delta Organic Soils - below +5' mean sea level

The Delta organic soils were formed through the biochemical breakdown of marsh plants and grasses that existed prior to the development of the present levee system. The amount of organic soils in the Delta is constantly being reduced because of continuing decomposition and oxidation from both natural processes and farm practices. As a result, the lowland Delta islands are sinking at the rate of one to three inches per year and the actual acreage of the organic soils is also being reduced (T,LV,82:20-25).

The high permeability of organic soils and their low surface elevation compared to surrounding waterways produces high ground water table conditions. The high ground water table, along with problems associated with uneven decomposition and settlement of organic soils, makes subirrigation the primary method of water application for crop production. Subirrigation is the delivery of water to plant roots by capillary action from the underlying saturated soil strata. This form of irrigation, however, must be tied to a winter leaching program to remove salts accumulated in the root zone. In the organic, sub-irrigated soils, the salts are brought into the soil column from beneath the plant roots. The shallow water table prevents downward leaching of these salts after the irrigation has been completed. To lower the high level of ground water and provide adequate drainage, water must be pumped from beneath the soil profile of the lowlying Delta islands and discharged into the adjoining waterways.

high
water
table
↓
subirrigation

water must
be removed
from soil in
Delta organics
via pumping

4.4.1.2 Delta Mineral Soils - above +5' mean sea level

Delta mineral soils were formed through deposition of sands and minerals eroded from the Sierra Nevada by various streams tributary to the Delta. These soils are generally found in the Delta uplands. Since subirrigation is not practicable in the mineral soils, water is applied to the soil surface, usually through furrow, sprinkler, or flood irrigation. Leaching of the soils is also required along with occasional changes in cropping patterns. Unlike subirrigation of organic soils, in the mineral, surface-irrigated soils, the salts are brought into the soil column from above with the irrigation water. Excess salts are then removed at the end of the irrigation season by applying irrigation water to flush the salt into the lower ground water table. Some leaching may also be accomplished with winter rainfall.

4.4.1.3 Crop Production

Crop production information was presented by DWR for the Delta lowlands and uplands (DWR,304). Corn was the predominant crop grown in the Delta during the period 1977-84, accounting for 25.8 percent of the total acreage (Table 4.4.1.3-1). Grain is grown on an additional 21.5 percent of the acreage, followed by tomatoes, alfalfa and mixed pasture; other crops such as sugar beets, deciduous trees and safflower account for the majority of the remainder. Crops and livestock production in the Delta has a gross sale value of approximately \$500 million (Table 4.4.1.3-2), with field and truck crops making up 57 percent of that total.

TABLE 4.4.1.3-2
ECONOMIC VALUE OF DELTA CROPS AND LIVESTOCK

| Agricultural Category | Gross Value Delta Area | | |
|------------------------|------------------------|---------|---------|
| | Lowland | Upland | Total |
| | (\$ Million) | | |
| Field Crops | 100.4 | 67.2 | 167.6 |
| Truck Crops | 76.9 | 34.6 | 111.5 |
| Tree Fruit, Nut & Vine | 25.1 | 18.2 | 43.2 |
| Seed & Nursery | 7.9 | 1.8 | 9.7 |
| Livestock | 9.9 | 144.5 | 154.5 |
| TOTAL | \$220.2 | \$266.3 | \$486.5 |

{ 4.4.1.4 Salinity Tolerance }

A major question to be addressed in setting salinity standards for agriculture is, "What is the salt tolerance of the crops grown in the Delta?" Several parties presented information on this topic (DWR,327,328; CCWD,50; SDWA,105,109,117; SWRCB,22,23,26). Table 4.4.1.4-1 presents selected information concerning salt threshold and yield levels for sensitive and moderately sensitive crops (DWR 328). The salt threshold for a particular crop is the level below which no loss in yield is experienced due to soil salt conditions.

TABLE 4.4.1.3-1
 1977 to 1984 CROP ACREAGES AND PERCENTAGES*
 FOR THE SACRAMENTO-SAN JOAQUIN DELTA
 FROM DWR 304

| Crop | Lowlands & Uplands | | Lowlands | | Uplands | |
|----------------|--------------------|-------|----------|-------|---------|-------|
| | ac. | % | ac. | % | ac. | % |
| Field Corn | 132,770 | 25.8 | 107,480 | 30.6 | 25,290 | 15.6 |
| Grain | 110,900 | 21.5 | 81,960 | 23.4 | 28,940 | 17.8 |
| Tomatoes | 43,100 | 8.4 | 25,370 | 7.2 | 17,730 | 10.9 |
| Alfalfa | 39,770 | 7.7 | 24,350 | 6.9 | 15,420 | 9.5 |
| Mixed Pasture | 36,020 | 7.0 | 17,730 | 5.0 | 18,290 | 11.3 |
| Sugar Beets | 27,650 | 5.4 | 15,240 | 4.3 | 12,410 | 7.6 |
| Deciduous | 25,960 | 5.0 | 9,240 | 2.6 | 16,720 | 10.3 |
| Safflower | 23,530 | 4.6 | 21,060 | 6.0 | 2,470 | 1.5 |
| Asparagus | 23,400 | 4.5 | 21,840 | 6.2 | 1,560 | 1.0 |
| Beans | 17,580 | 3.4 | 4,690 | 1.3 | 12,890 | 7.9 |
| Sunflower | 6,630 | 1.3 | 6,050 | 1.7 | 580 | 0.4 |
| Vineyard | 4,870 | 1.0 | 4,150 | 1.2 | 720 | 0.5 |
| Sorghum | 4,580 | 0.9 | 3,600 | 1.0 | 980 | 0.6 |
| Cole Crops | 4,140 | 0.8 | 3,610 | 1.0 | 530 | 0.3 |
| Melons | 2,430 | 0.5 | 250 | 0.1 | 2,180 | 1.4 |
| Sudan | 2,180 | 0.4 | 710 | 0.2 | 1,470 | 0.9 |
| Potatoes | 2,160 | 0.4 | 2,160 | 0.6 | 0 | 0.0 |
| Rice | 1,810 | 0.4 | 480 | 0.1 | 1,330 | 0.8 |
| Native Pasture | 1,130 | 0.2 | 140 | 0.0 | 990 | 0.6 |
| Misc. Truck | 1,120 | 0.2 | 750 | 0.2 | 370 | 0.2 |
| Lettuce | 1,110 | 0.2 | 0 | 0.0 | 1,110 | 0.7 |
| Onions | 590 | 0.1 | 370 | 0.1 | 220 | 0.1 |
| Misc. Field | 510 | 0.1 | 460 | 0.1 | 50 | 0.0 |
| Clover | 450 | 0.1 | 440 | 0.1 | 10 | 0.0 |
| Carrots | 300 | 0.1 | 300 | 0.1 | 0 | 0.0 |
| Peppers | 250 | 0.0 | 50 | 0.0 | 200 | 0.1 |
| Nursery | 60 | 0.0 | 0 | 0.0 | 60 | 0.0 |
| TOTAL | 515,000 | 100.0 | 352,480 | 100.0 | 162,520 | 100.0 |

*Percentages computed by State Board staff

TABLE 4.4.1.4-1
 DELTA SERVICE AREA
 CROP SALT SENSITIVITY
 (DWR, 328)

| <u>Crop</u> | Salt Sensitivity (Crop Salt Sensitivity) | |
|-----------------------------------|---|---|
| | Threshold ECe ^{1/} ds/m | Loss in Yield per Unit Increase in ECe Beyond Threshold |
| <u>Sensitive Crops</u> | | |
| Beans | 1.0 | 19% |
| Onions | 1.2 | 16% |
| <u>Moderately Sensitive Crops</u> | | |
| Fruits & Nuts | | |
| Almonds | 1.5 | 19% |
| Apricots | 1.6 | 24% |
| Peaches | 1.7 | 21% |
| Grapes | 1.5 | 9% |
| Corn | 1.7 ^{2/} | 12% |
| Corn (subirrigated, organic soil) | (2.1) | |
| Potatoes | | |
| Miscellaneous | | |
| Truck Crops | | |
| Carrots | 1.0 | 14% |
| Lettuce | 1.3 | 13% |
| Cabbage | 1.8 | 9.7% |
| Broccoli | 2.8 | 9.2% |
| Alfalfa | 2.0 | 7.3% |
| Tomatoes | 2.5 | 9.9% |
| Sudan | 2.8 | 4.3% |
| Rice | 3.0 | 12% |

1/ ECe means Electrical Conductance of the soil saturation extract, reported as deci Siemens per meter (ds/m).

2/ This tolerance of corn shown is for corn grown on a mineral soil using conventional methods of surface irrigation (furrow or sprinklers). The Delta corn trials (reported by Hoffman, et al., 1983) indicate a corn tolerance a little higher for corn grown on the Delta peat under subirrigation. It is reported to be ECe=2.1 ds/m, or 23% higher. This is probably due to the higher water content of the peat. The usual tolerance (for mineral soils) can be multiplied by a factor of 1.23 to obtain tolerance of similar crops grown on subirrigated soils.

4.4.2 Bay Agriculture

Very little information was presented in the hearing sessions on agriculture, as a beneficial use, outside of the legal limits of the Delta but within the boundary of San Francisco Bay. Contra Costa Water District presented records showing crop production for their district (CCWD,48) (Table 4.4.2-1).

TABLE 4.4.2-1--CROPS PRODUCED IN CONTRA COSTA WATER DISTRICT, 1986

| <u>Crop</u> | <u>Acres</u> |
|------------------------------------|--------------|
| Corn | 10 |
| Alfalfa | 20 |
| Irrigated Pasture | 30 |
| Other miscellaneous field crops | 60 |
| Apricots | 10 |
| Grapes* | 500 |
| Almonds* | 700 |
| Walnuts | 10 |

* Not irrigated in 1986

4.5 Estuary Fishery Habitat Beneficial Uses

The fishery resources of the Estuary depend on its complex ecosystem for a variety of purposes during different life stages and in different seasons and water year types. The Estuary provides habitat for close to 150 fish species and a vast aquatic food web of invertebrates, including shellfish and crustacean, and planktonic organisms. The fishery provides valuable resources for many other terrestrial and aquatic wildlife species as well.

The relationship of fishery habitat requirements to water quality has been documented for relatively few species. Studies normally focus on important commercial and recreational species such as Bay shrimp, Dungeness crab, Chinook salmon, striped bass, and American shad, among others. There is still a great deal of debate about the relationship between water quality and quantity and the changes in fishery resources even for the well studied species.

Beneficial uses of the Estuary's fishery comprise four major categories in the current Water Quality Control Plans (Basin Plans) for the San Francisco and Central Valley Regional Water Quality Control Boards, Regions 2 and 5, respectively. These are:

- Freshwater Habitat -- which provides habitat to sustain aquatic resources for cold water (COLD) and warm water (WARM) species.
- Fish Migration (MIGR) -- which provides a migration route and temporary aquatic environment for anadromous and other fish species. This beneficial use is also subdivided for warm and cold water species.
- Fish Spawning (SPWN) -- which provides a high quality aquatic habitat suitable for fish spawning.

- Preservation of Rare and Endangered Species (RARE) -- which provides an aquatic habitat necessary, at least in part, for the survival of certain species established as being rare and endangered.

The following sections 4.5.1--4.5.2.3 summarize available information on the fishery beneficial uses of the Estuary, including invertebrates. There are two major subdivisions: Section 4.5.1 discusses fishery habitat beneficial uses for species mostly using freshwater habitat; Section 4.5.2 discusses those which mostly use estuarine habitat. The information presented in this chapter will be used in Chapters 5 and 7 to determine what levels of protection are optimal and reasonable for the fishery habitat in the Bay-Delta Estuary.

4.5.1 Delta Habitat

This section considers the habitat for species that primarily use the freshwater of the Delta. Suisun Bay and the other lower estuarine areas (San Pablo, San Francisco and South bays) are discussed in Section 4.5.2..

4.5.1.1 Phytoplankton and Zooplankton

The importance of phytoplankton and zooplankton (including the opossum shrimp, Neomysis mercedis) as the basis for the food chain of fish and larger invertebrates was discussed at length in Phase I of hearing record (see, for example, DFG,28,14; T,XXXIX,15:16-19,28:13-29:14,70:19-71:8;T,XLI,52:19-53:5,59:1-4). The young of striped bass and other game fish, and all life stages of forage fish, feed on zooplankton and Neomysis (DFG,28,1), which in turn feed on smaller zooplankton and phytoplankton (DFG,28,1-4). Phytoplankton abundance is itself dependent on light, flow, salinity and nutrients. The complex interactions of these components are discussed in the hearing record.

While phytoplankton and zooplankton in the Delta food chain are undoubtedly important, the evidence presented is not sufficiently definitive to develop specific objectives for the protection of phytoplankton or zooplankton. A variety of factors have led to this conclusion:

- Changes in the Delta

There have been extensive changes in recent years in the Delta area, the effects of which are poorly understood. These changes include: (1) the introduction of the Asian copepod, Sinocalanus doerrii, and its apparent displacement of the native copepod, Eurytemora affinis from the central Delta area (DFG,28,25-28); (2) changes in phytoplankton bloom patterns in the Delta, with the appearance of dense blooms of the chain diatom, Melosira (DFG,28,14-19); (3) changes in Delta outflow, salinity and rate of exports (DFG,20,22-25); and (4) increases in releases of water from New Melones Reservoir for interim improvement of southern Delta water quality (T,XV,21:1-9).

- Limitations on Data and Analysis

Limited available data precluded critical analyses needed to evaluate potential flow and salinity objectives to protect these beneficial uses. For example, almost no data were presented from the 1960's, prior to the operation of the SWP; thus the effects of increased export operations could not be analyzed. Data presented by DFG (Exhibit 28) tended to lump data into pre-drought (1969-1975) and post-drought (1978-1985) periods, even though they noted that some of the changes discussed in the post-drought period began to occur prior to the 1976-1977 drought (DFG, 28, 16, 31). In addition, much of the data was presented as March-November averages, which tended to prohibit interpretation of the data during critical periods of the year, such as the spring spawning period for striped bass. Data averaged in this way reduced the usefulness of the evidence for the purpose of setting objectives.

- Absence of Definitive Relationships

Limits on data collection design and data interpretation prevented development of definitive relationships among data sets. For example, USBR testified that the phytoplankton data they collected were not used to make connections with other parts of the food chain (T, LXII, 109:7-18). The DFG presentations on the relationship between chlorophyll a levels and abundance of various zooplankton used the March-November average abundance levels for both factors (DFG, 28, 61-74). However, in most years, blooms occur for only a small portion of this nine-month period. Therefore, the effects of blooms on zooplankton abundance, an important concept in much of the discussion, is lost because the long-term average chlorophyll a is at background or non-bloom levels (<10 ug/l). Seasonal and geographic differences are also obscured because only one data point is presented for each year.

For these reasons, no objectives are proposed specifically for the protection of phytoplankton or zooplankton in the Delta. It is anticipated, however, that the objectives proposed for the protection of other beneficial uses may provide substantial protection for these aquatic resources as well.

Should additional evidence indicate that these aquatic resources are not being protected, and the evidence is sufficiently definitive to propose objectives, this issue may be reexamined at a later date.

4.5.1.2 Chinook Salmon

- Races and Migration

Chinook, or king salmon, Onchorhynchus tshawytscha, is a native, coldwater, anadromous species of major commercial and recreational importance in California. The total annual sport and commercial harvest of chinook salmon produced in the Central Valley since 1957 averages over 400,000 fish. The estuarine gill net fishery for salmon was outlawed in 1957. Since then the ocean commercial troll harvest of Central Valley salmon has averaged about 324,000 fish, approximately 57 percent of all Chinook harvested in California. The ocean recreational catch has averaged close to 60,000 fish and the inland sport harvest is estimated to be about 35,000 fish (USFWS,31,103,176-179;DWR,56,57-59).

Adult Chinook salmon migrate through the Estuary from the ocean to spawning areas in the upper Sacramento-San Joaquin River basins. Four races, all believed to be genetically distinct (USFWS,31,109), spawn in the upper Sacramento Basin (USFWS,29,4). Each race is named for the time of year when the upstream migration (run) occurs. There are fall, late-fall, winter and spring runs. Because the spawning runs of the four races overlap in the upper Sacramento River, all life stages may be found in all months (see Figure 4.5.1.2-1). The occurrence of four races of Chinook salmon in a single river basin is unique in the United States (T,XXXV,16:24-17:1).

The fall race, comprising 90 percent of all Chinook spawning in the Central Valley, migrates upstream from about late July through December (USFWS,29,5). Smaller populations of late-fall, winter, and spring run fish spawn in the upper Sacramento River (see Figure 4.5.1.2-2). The winter run was formerly the second largest but today is the smallest (T,XXXV,22:6-14); it is now under consideration as a candidate for endangered species status. The Sacramento River and its tributaries produce 80 percent of all Central Valley Chinook salmon (USFWS,31,1) with almost 20 percent contributed by the San Joaquin River Basin in some years (DFG,15,Appendix 1).

Prior to the closure of Friant dam on the San Joaquin River, there was a spring run in the upper river (DFG,15,8). Today, only the fall run spawns in the Merced, Tuolumne and Stanislaus rivers (DFG,15,4). There are also small runs in the Mokelumne and Cosumnes Rivers (SWRCB,435,35).

FIGURE 4.5.1.2-1 Timing of life history stages for the four races of Chinook salmon in the Sacramento River Basin (after USFWS, 29, 5, Figure 2)

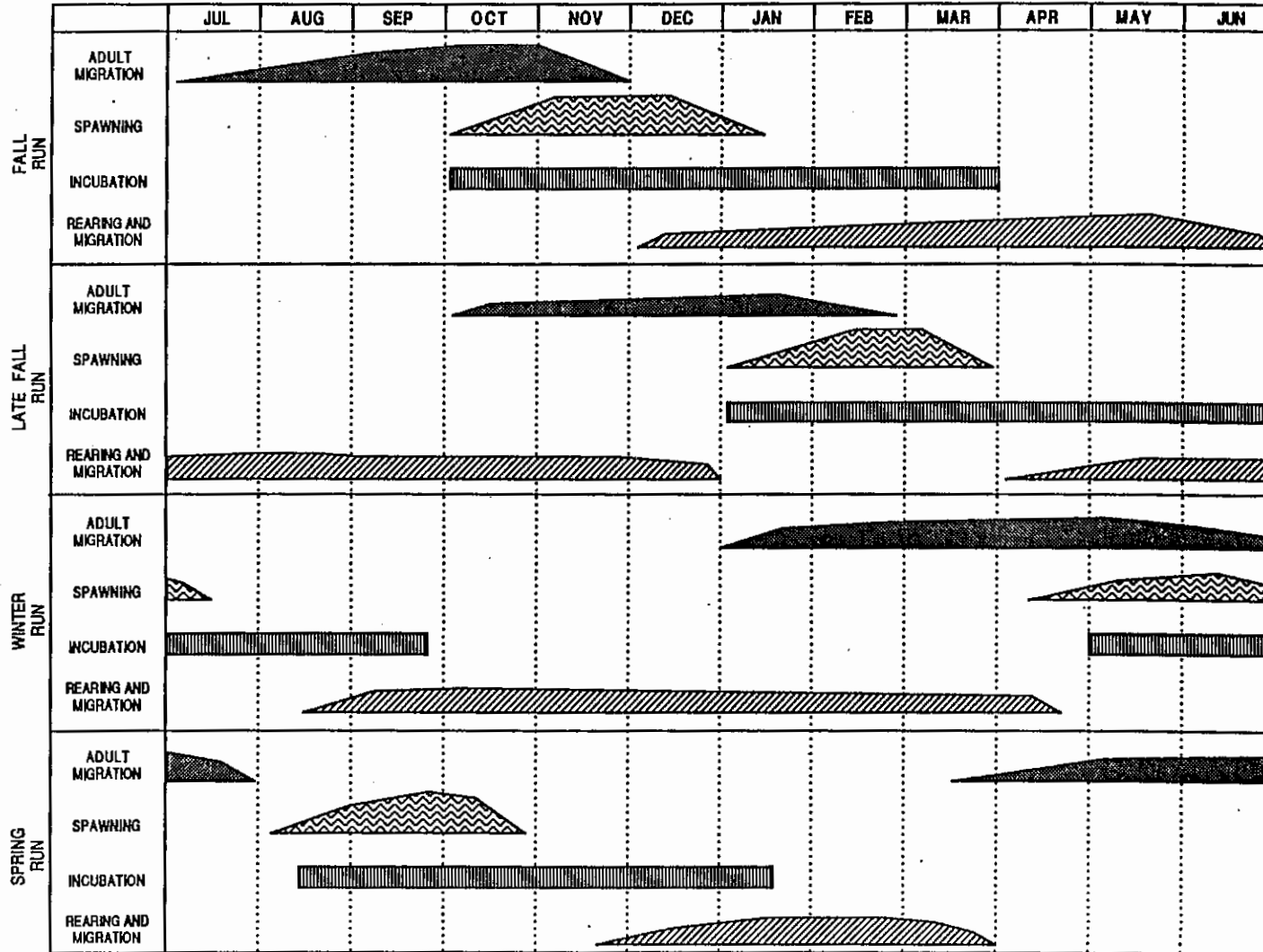

**FIGURE 4.5.1.2-2 Spawning escapement of the four races of Chinook salmon
in the Upper Sacramento River Basin
(after USFWS, 29, 7-10, Figures 3-6)**

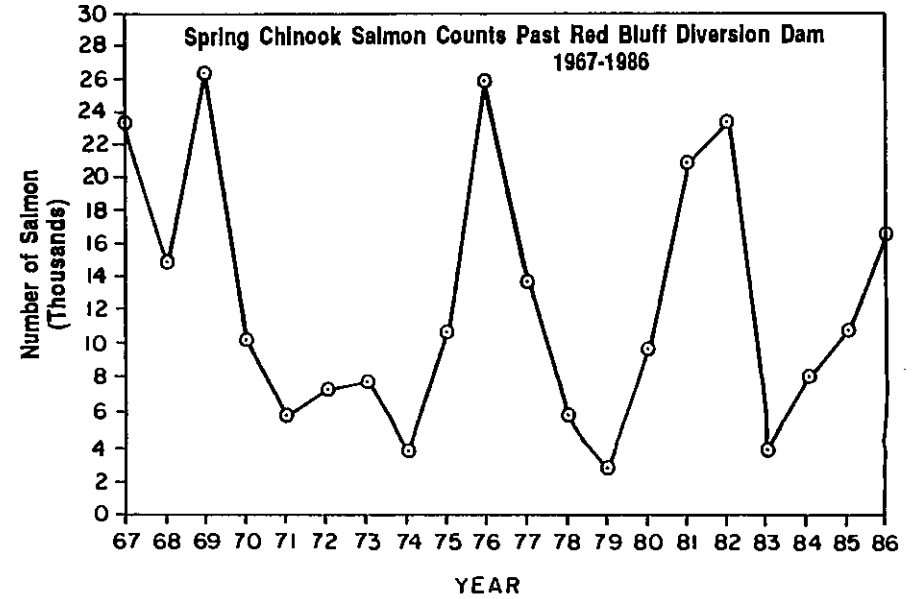
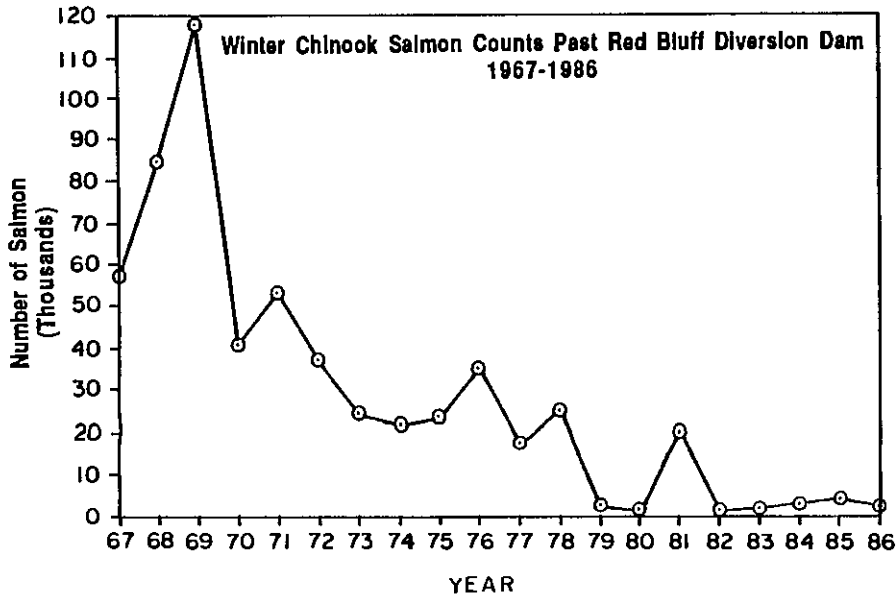
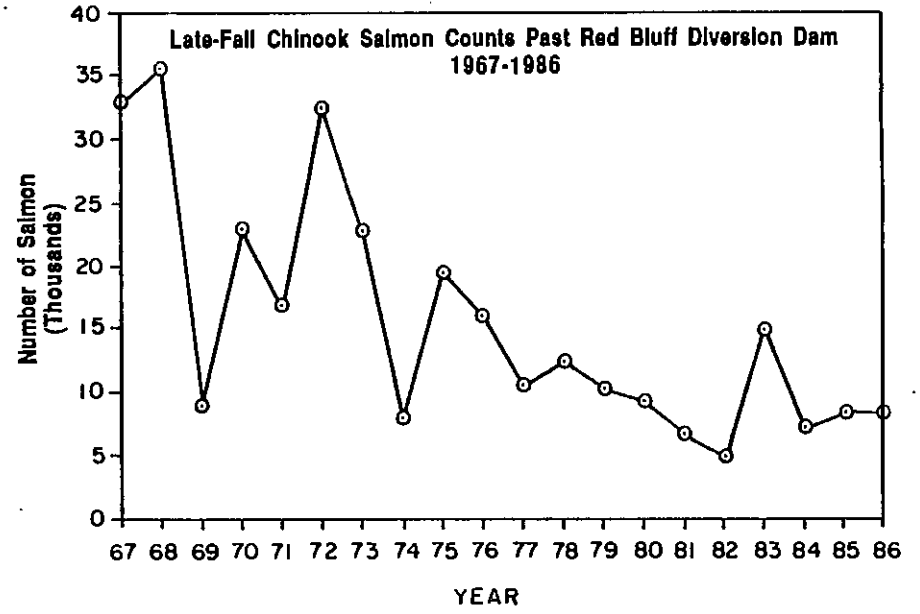
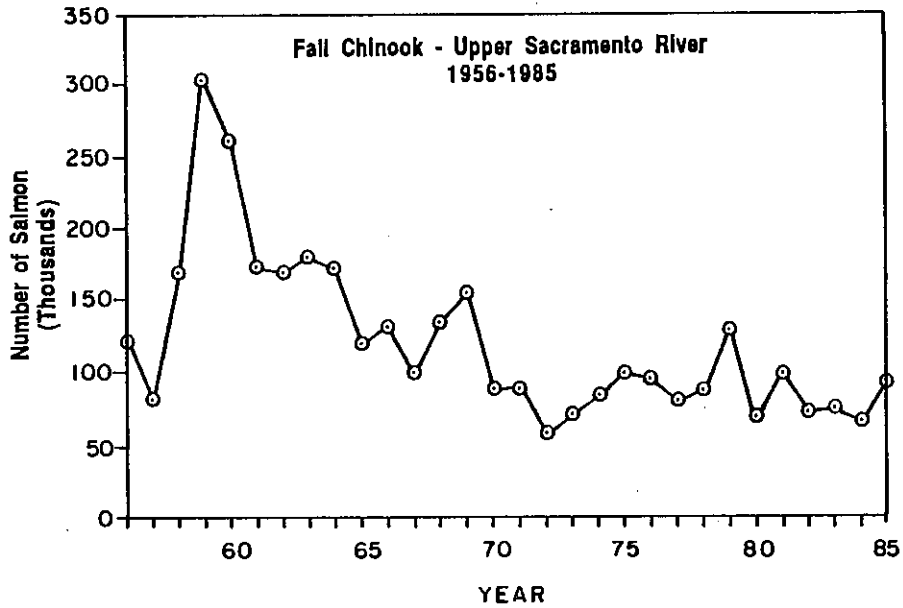

4-16

- Development and Migration

The developmental stages and habitat requirements for each stage are generally the same for the four races of Chinook salmon in the Central Valley. However, the different life stages use different locations and require different habitat conditions as they develop within the Sacramento-San Joaquin River basins. The water quality and habitat requirements of each life stage, their location and duration are shown in Table 4.5.1.2-1.

Chinook salmon are a cold water species. Water temperatures below 60°F are required for spawning and the survival and growth of eggs and fry (USFWS,29,4; USFWS,31,4;T,XXXV,43:6-8). The virulence of many diseases affecting Chinook salmon is reduced when temperatures are below 60°F (USFWS,29,23). Juvenile emigrants (smolts) can tolerate water temperatures somewhat higher than 60°F but above about 65°F a variety of stress effects occur (DWR,562,3; DWR,563,1-3; USFWS,31,4; DFG,15,23-27). At temperatures of about 68°F or more, smolts are highly stressed (DFG,15,25-26); 76°F is lethal (USFWS,31,42).

Most naturally spawning Chinook salmon typically return to the stream where they hatched (home stream) at three years of age (DFG,15,18) (two and one-half years after their smolt migrating) or more. During the upstream migration, adults depend on sensing the chemical composition of the water for olfactory cues acquired during their juvenile emigration. Downstream flows of home stream water are necessary for successful spawning migration. If these flows are inadequate or have been diverted, migration delays can occur (USFWS, 31,94).

Adults follow the salinity gradient to the western Delta. Peak numbers of adult migrants, from the fall, late fall, and winter runs move through the Estuary from October to February (USFWS, 31, 93). However, because the spawning runs overlap, adults can be found in the Estuary during the entire year. In the western Delta, stocks from the two major river basins diverge. Most of the San Joaquin River fish follow the mainstem of the San Joaquin River into the tributaries although some use Old and Middle rivers (USFWS, 31, 93). Most Sacramento River Basin Chinook are thought to use the mainstem, though some travel through the Central Delta via the lower forks of the Mokelumne River (USFWS 31, 93).

Spawning, incubation and early rearing take place primarily upstream of the Delta. However, some fry also rear also takes place in the Estuary. While rearing, young salmon feed for about two months or more on a diet of aquatic and terrestrial insects and zooplankton (USFWS,29,4;USFWS,31,14; SWRCB,450,5-4). Peak fry abundance occurs in the Delta in February and March (USFWS,31,7). As they grow and move into the Estuary, Neomysis (opossum shrimp), Corophium (an amphipod) and Crangon (Bay shrimp) become important prey items (SWRCB,433,113).

Table 4.5.1.2-1--Chinook Salmon Environmental Requirements and Life History Stages

| Life Stage | Location | Duration (race) | Flow | Water Quality | Other |
|-------------------------|---|--|---|--|---|
| Adult Migration | Pacific Ocean Bay-Delta to upstream | July-Dec (fall) Oct-Mar (late fall) Jan-June (winter) mid Mar-Aug (spring) | Adequate flow of home stream water to locate spawning grounds and cover redds | Temperature <68°F Dissolved oxygen >5mg/l marine to freshwater | |
| Spawning | Upper reaches of all major rivers and streams in Sacramento-San Joaquin River Basins below dams | Oct-mid Jan (fall) Jan-Apr (late fall) Apr-mid July (winter) Aug-Nov (spring) | Stable flow without extreme fluctuations sufficient to cover and aerate redds | Temperature <56°F Dissolved oxygen >7mg/l freshwater | Clean gravel substrate with good circulation through redd |
| Incubation (Egg-Alevin) | Spawning grounds (see above) | Oct-Apr (fall) Jan-Jul (late fall) May-Oct (winter) mid Aug-mid Jan (spring) | same as above | same as above | |
| Rearing (Fry-Juvenile) | Upstream, Delta, and upper estuary | Dec-Mar (fall) Apr-Aug (late fall) mid Aug-Nov (winter) late Nov-Jan (spring) | Stable flow to prevent stranding Can tolerate greater flows and velocities as they mature and move into deeper water | Temperature optimum=54°F freshwater | Diet of aquatic and terrestrial insects, crustaceans |
| Smolt Migration | Bay-Delta Estuary to Pacific Ocean | Apr-June (fall) Aug-Jan (late fall) Nov-late Apr (winter) Feb-Apr (spring) | Tolerates higher flows typical of spring snow melt or rainy season. Helps move smolt downstream | Temperature <68°F Dissolved oxygen >5mg/l estuarine to marine | Diet of <u>Neomysis</u> <u>Crangon</u> , <u>Corophium</u> , and aquatic and terrestrial insects |

Salmon smolts migrate downstream through the Delta in all but the summer months when water temperatures reach lethal levels (USFWS,31,17-19). Including naturally produced fish and hatchery reared salmon released in or above the Delta (USFWS,31,27), the annual fall smolt run that passed Chipps Island between 1978 and 1985 was estimated to range from 10 to 50 million fish (USFWS,31,25). On the average, it takes an individual fall run smolt three weeks to emigrate from the upper Sacramento to the ocean, one week to reach the Delta and about two weeks to pass through the Delta and Bay (USFWS,31,32). Smolt emigration through the Delta usually peaks in May (Figure 4.5.1.2-3) (USFWS,31,22). However, smolts from different tributaries leave their natal streams and move into the Delta at different times and there are year to year variations in the timing of emigration (USFWS,31,23). The fall run emigration from April through June (USFWS,31,17) coincides with historical flow increases caused by snow melt (DWR,561,6). San Joaquin River Basin fall run smolts emigrate somewhat earlier during this period than Sacramento River Basin smolts (USFWS,31,23). The increase in Delta smolt abundance observed in October and November is probably the late fall race or yearling, fall run salmon. The winter or spring run emigrates from January through March. Peak abundance of salmon salvaged at the state's Delta pumping plant confirm this seasonal pattern of young salmon abundance in the Delta (see Figure 4.5.1.2-3).

- Survival and Abundance

Smolts migrate downstream to the ocean where they mature for two or more years. Recoveries of adults in the ocean, tagged as smolts and released in Suisun Bay, indicate that only about two percent survive. Thus, 10 to 50 million smolts would produce 200,000 to 1,000,000 fish available to the ocean fishery (USFWS,31,27). The number of fish escaping harvest and mortality and returning to the spawning grounds each year is known as annual escapement. Survival from eggs to returning adults in a stable population was reported to average 0.04 percent (DWR,561,3). No detailed evidence was presented regarding overall survival rates for Sacramento-San Joaquin Basin Chinook salmon.

The USFWS estimated that the abundance of naturally produced Chinook salmon has decreased by over 50 percent since the DFG began recording Central Valley escapement in the early 1950's when the population averaged over 400,000 fish (see Figure 4.5.1.2-4) (USFWS,31,1). From about 1955 until 1965, Sacramento Basin Chinook salmon escapement averaged above 250,000 fish. However, according to calculations by the DWR, over the last 20 years the total number of naturally produced adult salmon has declined to around 100,000 fish while escapement of hatchery reared fish has increased to about 90,000 fish (see Figure 4.5.1.2-4)(DWR,559,74). Escapement of nonhatchery salmon of all runs except the spring run have shown a consistent downward trend (see

FIGURE 4.5.1.2-3 Mean monthly salvage of Chinook salmon at the State Water Project fish protective facility, 1968 - 1986 (from DFG, 17, Appendix , Table 4)

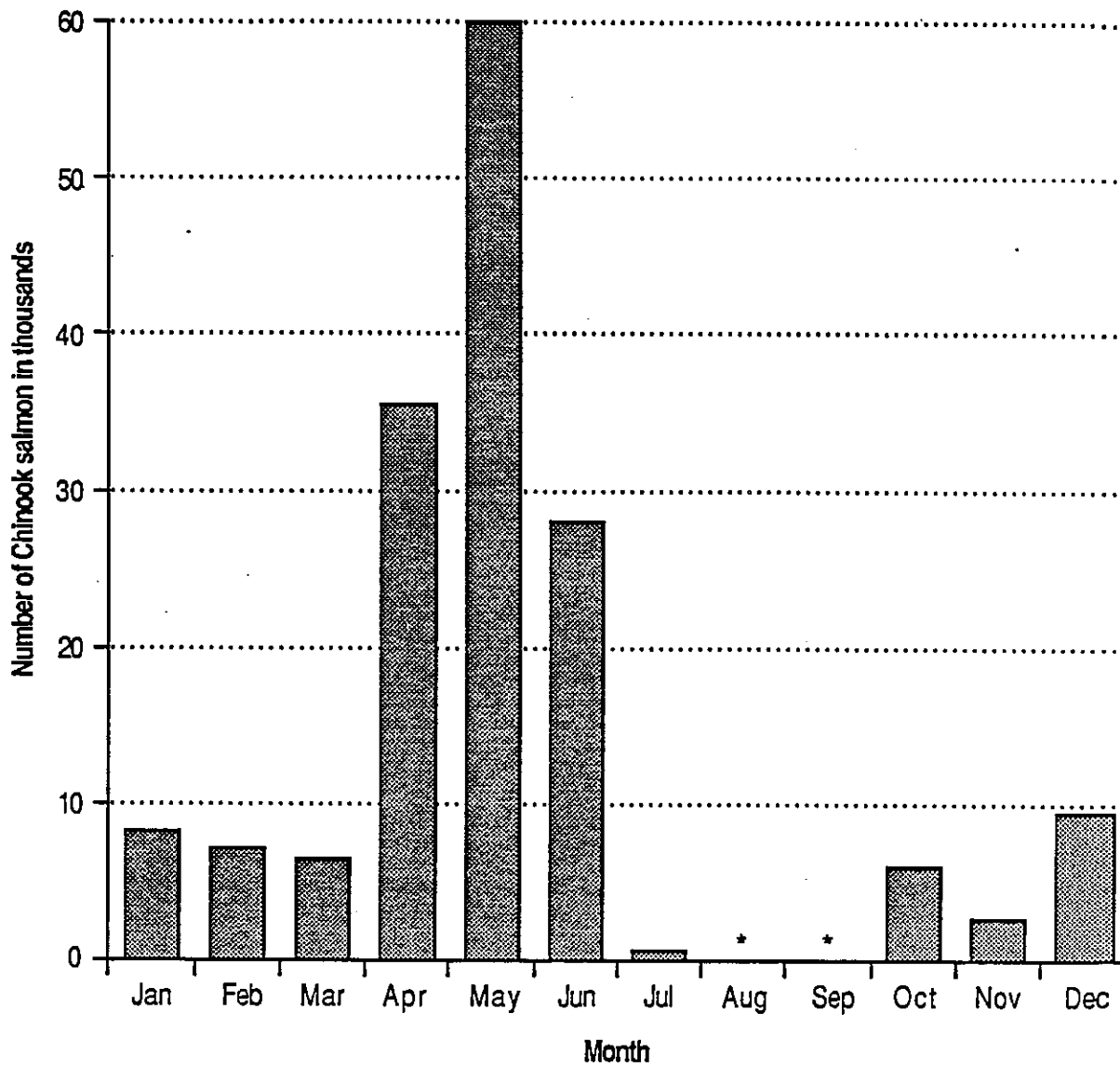

* about 100 fish

FIGURE 4.5.1.2-4 Total Sacramento Basin fall run spawning Chinook salmon. Light bars are estimates of natural production, dark bars are estimates of production from Feather and American River hatcheries. Production from Coleman National hatchery is not included. (after DWR, 559,78, Figure VI-1)

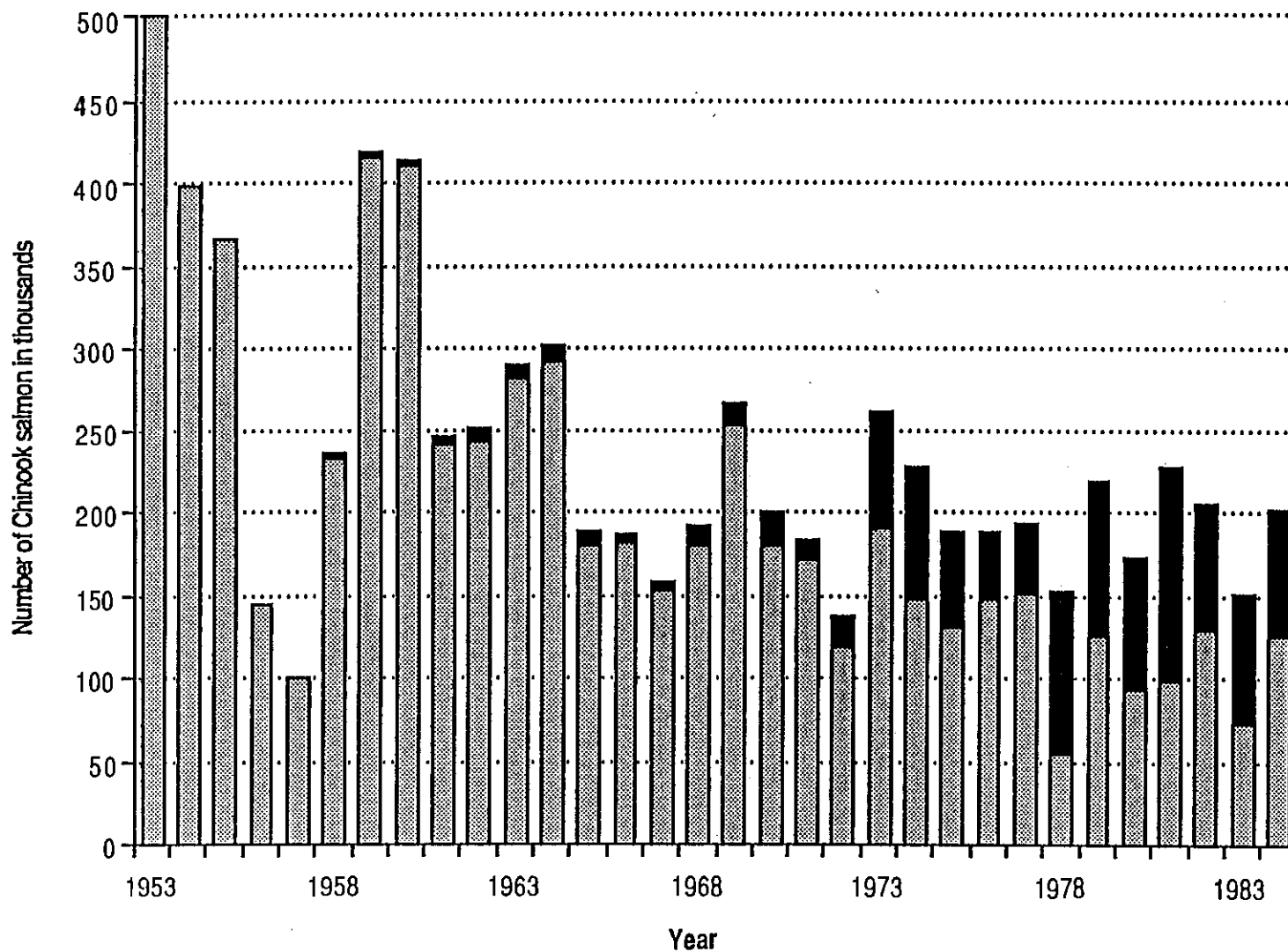

Figure 4.5.1.2-2). Upstream factors identified as contributing to the decline in natural salmon production include loss of habitat from construction and operation of dams and diversions (T,XXXV,25:20-23;DFG,15,8;T,XXXV,33:7-37:12). Stressful to lethal water temperatures, reduced or fluctuating flows, and harmful concentrations of toxins are also factors (USFWS,29;DWR,561)

Annual Sacramento Basin escapement and commercial ocean harvest have become relatively stable in the last 20 years due to the practice of taking immature Chinook salmon from the Feather and American River hatcheries and releasing them below the Delta (DWR,559,47-74; USFWS,31,2). Survival of these fish is six to eight times better than naturally or hatchery produced fish emigrating from upstream of the Delta (T,XXXVII,153: 2-154:1;T,XXXVII,161:22-162:1).

DWR's consultant reported that the Feather and American River hatcheries support. A significant proportion of spawning runs and the commercial catch (T,XXXVII,151:13-18, 14:1-14;T,XXXVI,140-10-21). Between 1978 and 1984, it has been estimated that hatcheries contributed an average of 87 and 78 percent to the American and Feather River runs, respectively (T,XXXVII,153:2-17), at least 16 percent or more to the upper Sacramento run, and an undetermined number to the Yuba River run (USFWS,29,12;T,XXXVII,152:6-22). DWR's consultant calculated that between 1978 and 1984 the Feather and American river hatcheries produced about 48 percent of total Sacramento Basin escapement and 44 percent of the ocean harvest of Central Valley Chinook salmon (T,XXXVII,151:22-152:5). This has enabled the commercial harvest of Central Valley Chinook to be maintained at around 350,000 to 450,000 fish and the catch to escapement ratio (harvest fraction) to double (T,XXXVIII,257:14-22) (see Figures 4.5.1.2-5 and 4.5.1.2-6).

San Joaquin Basin stocks, where the hatchery contribution to escapement is less than five percent (USFWS,31,107), still fluctuate widely (see Figure 4.5.1.2-7). Maximum adult escapement to the San Joaquin Basin appears to be correlated with high spring flow conditions two and one-half years earlier when young fish were produced and emigrating downstream (DFG,15,34-44;USFWS,31,64-66T,XXXVI,160:1-161:6). San Joaquin Basin escapement of 40,000 or more spawners is typical when spring outflows two and one-half years earlier are high (USFWS,31,65).

- Factors Contributing to Delta Survival

Delta conditions during smolt emigration have been identified as a major factor affecting salmon smolt survival and consequent adult escapement of hatchery and naturally produced Chinook (T,XXXVI,139:17-22). The primary changes identified by the USFWS, DFG and others to improve smolt survival in the Delta were: (1) higher spring flows, (2)

**FIGURE 4.5.1.2-5 Estimated ocean harvest fraction for California Chinook salmon (illustrates the relative proportion of salmon harvested commercially to spawning escapement in the Central Valley) (T,XXXVIII, 251: 20-25 and 257: 19-22)
(adapted from DWR, 570)**

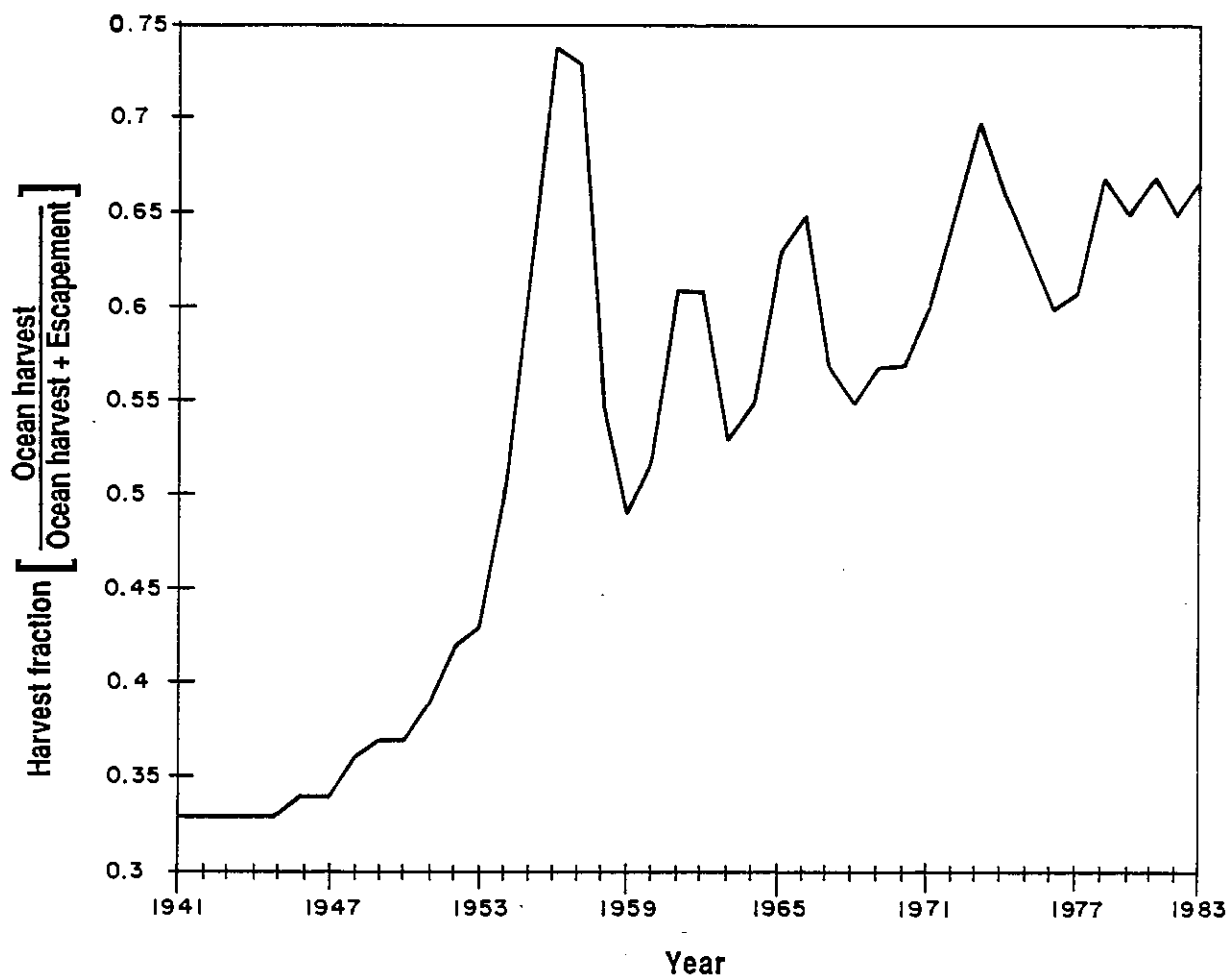

FIGURE 4.5.1.2-6 Estimates of annual ocean harvest of Central Valley Chinook salmon
(after DWR, 561, 2, Figure III-3)

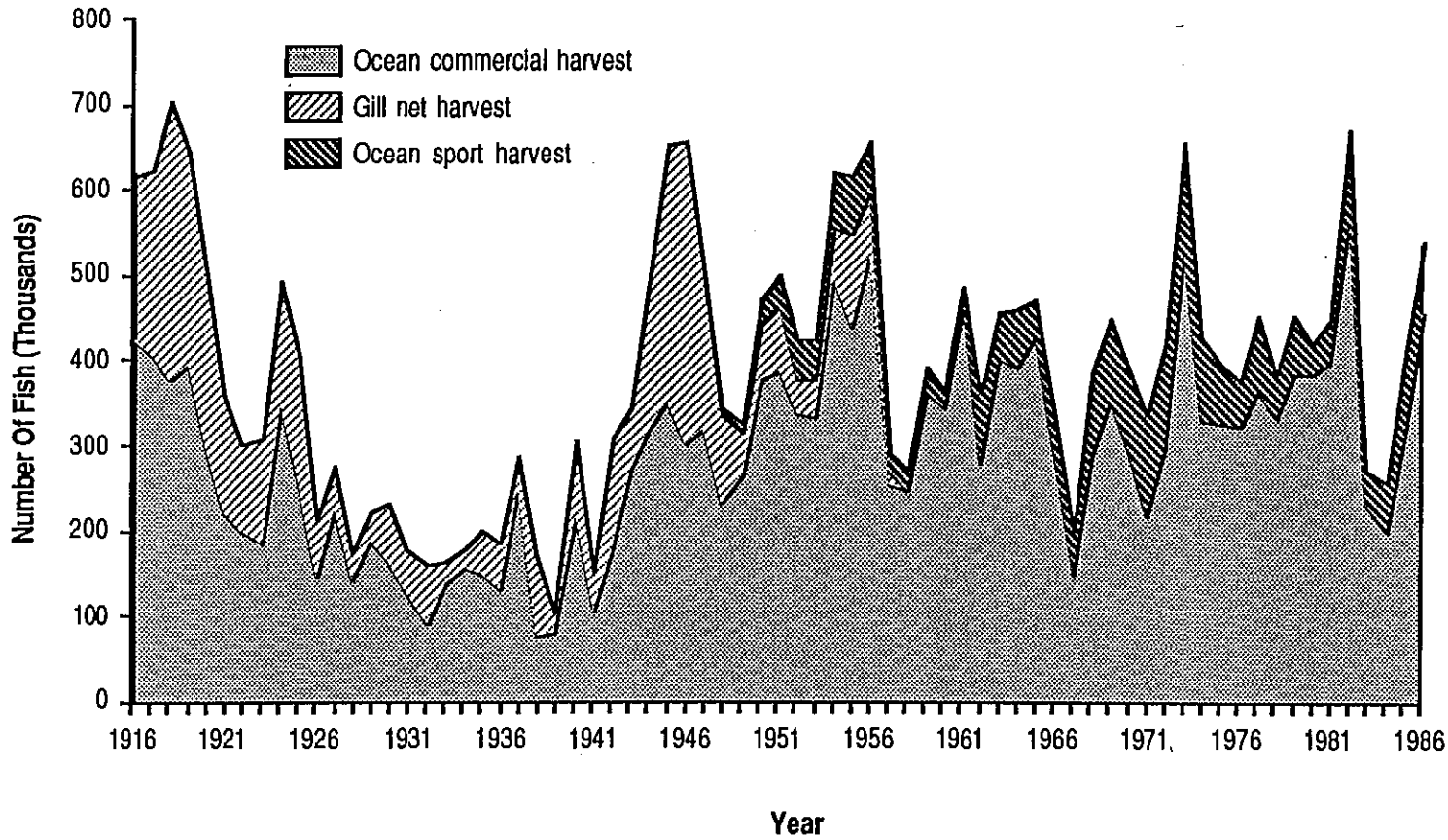
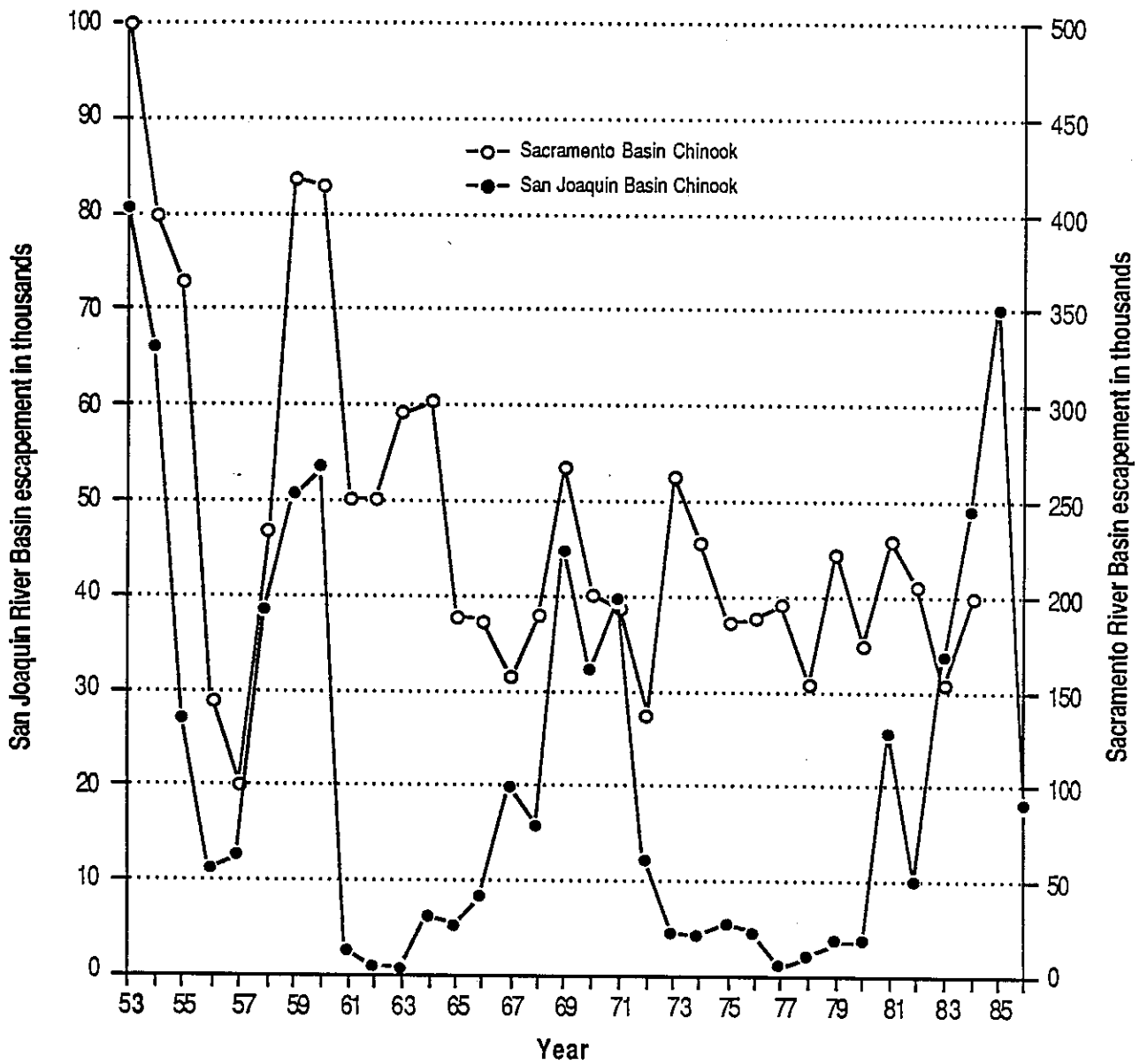

FIGURE 4.5.1.2-7 Comparison of total spawning escapement of Sacramento and San Joaquin River Basin Chinook salmon, 1953 - 1986 (from DFG, 15, Appendix 1)



temperatures below the stressful level of about 66 to 68°F, (3) "overcoming" the adverse impacts of water diversion that transport Sacramento Basin fish through the Delta Cross Channel, and (4) reverse flows in the lower San Joaquin that transport San Joaquin Basin fish away from their normal migration routes to CVP and SWP export pumps. (T,XXXVI,156:21-23; USFWS,31,62).

- Salmon Harvest and Economic Value

Table 4.5.1.2-2 shows the average estimated ocean commercial and sport catch of Central Valley Chinook salmon in California and an estimate of the proportion supported by hatchery production (DWR,559,45). The estimated 1977-1986 California commercial harvest of Chinook salmon from the Central Valley averaged well over 300,000 fish per year (USFWS,31,177,Appendix 32), representing almost 60 percent of the total ocean catch of Chinook salmon in California during this period. The five year average price per salmon purchased "off the boat" was estimated to be \$26 in 1987. The average commercial catch for 1982-1986 was about 315,500 fish (USFWS,31,177), which translates to an average annual value of about \$8.2 million per year for the commercial fishery. The ocean sport harvest averages about 60,000 fish per year (see Figure 4.5.1.2-6). It is estimated that \$72 per day is spent for about 100,000 days of ocean recreational fishing, primarily party boat rentals, for an estimated annual value of \$7.2 million (Thomson and Hupert, 1987). USFWS presented an estimate for the inland sport harvest of Chinook salmon of 35,000 fish (USFWS,31,103). However, Meyer Resources (1985) reported the inland catch to be ten percent of the ocean catch (BISF,40,15), or about 6,000 fish. At a catch rate of 0.2 fish per day represents a range of about 1,200 (for 6,000 fish) to 175,000 (for 35,000 fish) angler days each year. Based on cost estimates for shore fishing (\$31 per day) to boat rental (about \$48/day) the estimated annual value of the inland recreational Chinook fishery ranges from \$37,300 to \$57,500 for the lower catch estimate to \$5.4 to \$8.4 million for the upper catch estimate. The value of Central Valley Chinook salmon harvested in California's inland and coastal waters is estimated to range from a minimum of approximately \$15.8 million to a maximum of approximately \$23.8 million (see Table 4.5.1.2-3).

4.5.1.3. Striped Bass

Striped bass, Morone saxatilis, were successfully introduced into the Estuary at Martinez with the planting of about 140 fish from the Navesink River, New Jersey, on June 18, 1879. A second planting of 300 fish occurred in 1882 (BISF,58,2). The stock expanded quickly and before 1890 supported a commercial fishery that was terminated in 1935 due to a population decline (BISF,47,27). While important recreational fishery continues to the present, recent declines have caused concern.

Table 4.5.1.2-2. Estimated Average Annual Harvest of Chinook Salmon and the Hatchery Contribution to the Catch of Central Valley Salmon

| Year | Ocean Commercial Catch 1/ (1) | Commercial Catch of Central Valley Chinook 1/ (2) | Percent of Ocean Catch from Central Valley Chinook (2/1) (3) |
|-----------|-------------------------------------|--|--|
| 1952-1970 | 558,282 | 320,982 | 57 |
| 1971-1977 | 564,796 | 309,402 | 55 |
| 1978-1986 | 560,711 | 333,160 | 59 |

| Year | Sport + Commercial Catch of Central Valley Chinook (2+4) (5) | Ocean Commercial + Sport Catch of Hatchery Chinook 3/ (6) | Percent Hatchery Chinook in Central Valley Catch (6/5) (7) |
|-----------|--|--|--|
| 1952-1970 | 373,139 | 7,407 | 2.0 |
| 1971-1977 | 401,010 | 88,603 | 22.1 |
| 1978-1986 | 397,026 | 141,291 | 35.6 |

1/ from DWR,561,57, Appendix A-3

2/ from DWR,561,58-60, Appendix A-4

3/ from DWR,559,44-45, Table III-4. The period of time covers 1957-1970 for the American River hatchery alone. Subsequent years include the Feather River hatchery production through 1984. Contributions by other Central Valley hatcheries were not determined.

Table 4.5.1.2-3--Estimated Dollar Value of
Chinook Salmon caught in California

| Commercial Fishery (million \$) | Sport Fishery ^{1/} (million \$) | | Total (million \$) |
|------------------------------------|---|-------|-----------------------|
| | Inland | Ocean | |
| | .373-.575 | 7.2 | 15.8-16.0 |
| 8.2 | 5.4-8.4 | | 20.8-23.8 |

^{1/}Estimates of the size of the inland fishery vary widely from 6,000-35,000 fish. Therefore the estimated dollar value was calculated for both these estimates.

- Migration and Spawning

The striped bass is an anadromous fish. Most of its adult life is spent in San Francisco Bay and adjacent ocean areas (T,XLI,67:1-7). In the fall the adults migrate upstream and spend the winter in Suisun Bay and the western Delta. In spring the adults move farther upstream to spawn in the Sacramento River between Sacramento and Colusa and in the western and central Delta portion of the San Joaquin River between Antioch and Venice Island (T,XLI,67:1-16). The Delta spawning area is delimited by ocean salinity downstream and by land-derived salinity in excess of 0.550 mmhos/cm EC upstream, typically around Venice Island (T,XLI,68:11-20). Temperature is also important for spawning, with initiation of spawning typically occurring as water temperatures increase to above 61° F (SWC,203,13;SWRCB,450,24-1). Spawning typically occurs in the Delta from late April through May and in the Sacramento River from mid-May to mid-June (T,XLI,67:22-25). About one-half to two-thirds of the eggs that are spawned are produced in the Sacramento River, with the remainder in the Delta (T,XLI,67:20-22).

About 3 mm in diameter, striped bass eggs drift with the currents and hatch in two to three days (T,XLI,69:11-13). The larvae first feed on the remainder of their yolk sacs and oil droplets and continue to drift until they are about six mm in length when they start feeding (BISF,47,35) on zooplankton (copepods and cladocerans). They soon consume larger organisms, especially the opossum shrimp, Neomysis mercedis, which remains the dominant food organism through the first two years of life before the bass shift to larger food, including Bay shrimp and forage fish (T,XLI,70:1-8).

The majority of bass larvae tend to concentrate in the entrapment zone in Suisun Bay and the western Delta, although in very high flow years the larvae may be dispersed farther down the Estuary (T,XLI,69:15-24). The lower San Joaquin River appears to be a less desirable nursery area than in former years. Higher larval mortalities here appear to be the cause for the decline of the Delta portion of the Striped Bass Index (SBI)(T,XLIII,30:17-23;31:11-15).

Striped bass represent a substantial resource throughout the Estuary, upstream on the Sacramento River, in coastal waters and in export canals and reservoirs (see Sections 4.9.3 and 4.9.5). In the years 1983 to 1985, sales of striped bass stamps (required by law for fishing) have averaged over 560,000 per year (NOAA,1986). Annual recreational catches of striped bass (excluding reservoirs and aqueducts) vary from 100,000 to 400,000 fish (T,XLI,70:17-18) taken mainly from private boats or along the shoreline. Charter boats take 10-15 percent of the catch (T,XLI,70:25-71:17). Apart from the fishery, striped bass are also valuable in the food chain of the Estuary. Their eggs and small larvae also serve as food for other fish and invertebrates. Being principal predators in the river and estuarine food chains, larger bass contribute to the control of the size of forage fish populations.

Extensive, multi-year studies of the striped bass population have all indicated a substantial decline in the population since the 1950's (SWC,203,16-19; DFG,25,8-10,28-30,39-41). Estimates of adult population size have declined from about three million in the early 1960's to less than one million fish currently (T,XLI,72:3-7;SWRCB,500,1). The current two-fish, 18-inch minimum length bag limit was established in 1982 in response to this decline, and the striped bass stamp was instituted to provide additional funds for research on this fish. A variety of theories have been proposed to explain the reasons for the decline (see Chapter 5).

4.5.1.4 American Shad

American shad, Alosa sapidissima, is a warm water, anadromous fish species. Shad were introduced to the Delta from the east coast in the late 1800's and within ten years a commercial gill net fishery developed. Over one million pounds (lbs) per year were regularly harvested. It is estimated (at an average weight of three lbs per fish) that this represented a catch of about two million shad, with a total population of two to three times this number (DFG,23,16). By the late 1940's the fishery declined, and by 1957 commercial fishing of shad ended when gill netting was prohibited to protect other fisheries (DFG,23,1; SWRCB,405).

A popular shad sport fishery exists in the Sacramento, San Joaquin, American, Feather, and Yuba rivers and in the Delta. Surveys in the late 1970's indicate that between 35,000 and 55,000 angler days were spent in catching about 79,000 to 140,000 shad (DFG,23,1-2). Estimates from a 1976-1977 survey indicate a population of about three million shad (T,XXXIX,13:11-12;DFG,23,15). No specific data on the value of the shad fishery is available. However, if shore fishing expenditures average about \$31 per angler day (Thomson and Huppert, 1987), the total annual value ranges from \$2.4 to \$4.3 million.

The life history stages and habitat requirements of American shad are shown in Table 4.5.1.4-1. Adult shad spend three to five years in the ocean before they reach maturity (SWRCB,450,3-3) and enter the lower Estuary in the fall; they migrate through the Delta from about March through May to upstream spawning grounds (T,XXXIX,13:23-24), actively feeding on copepods and cladocerans, as well as Neomysis and Corophium (DFG,23,12; SWRCB,433,100). Peak adult numbers occur in the upper Delta in May (DFG,23,5) at water temperatures ranging from about 57° to 75°F (DFG,23,4).

Historically, spawning occurred through the tidal fresh water reaches of the San Joaquin and Sacramento rivers and upstream (T,XXXIX,14:5-7) from about May through July. Today, the lower San Joaquin River no longer supports significant spawning activity because of poor water quality as well as low and reverse flows during the spawning season (T,XXXIX,14:23-24;SWRCB,450,3-3). Spawning occurs from May to June in the north Delta, the Sacramento River above Hood up to the Red Bluff diversion dam, and the major tributaries of the Sacramento River (DFG,23,2-4; SWRCB,450,3-3; DFG,13,21; SWRCB,405,41).

Table 4.5.1.4-1--American Shad Environmental Requirements and Life History Stages
 (from DFG, 23; DFG, 13; SWRCB, 405; SWRCB, 433)

| Life Stage | Location | Period | Flow | Water Quality | Other |
|---------------------|--|--------------------|---|-----------------------------|--|
| Adult Migration | from Pacific Ocean through Bay-Delta to upstream freshwater tributaries | March-May | low flows reduce size of run in tributaries | temperature 57-75° F | diet is <u>Neomysis</u> and other zooplankton |
| Spawning | upper Sacramento River to Red Bluff Diversion Dam and major tributaries, North Delta, Mokelumne and Old River. Formerly San Joaquin R. | April-early July | higher flows increase numbers spawning in tributaries | 63-75° F optimum = 60-70° F | spawn over sand or gravel |
| Egg Incubation | lower Sacramento R. below Colusa, Feather and American Rivers, Delta | May-July | higher flows carry more eggs into Delta | | |
| Rearing | same as above | June-Sept | more juveniles produced when flows are higher | | feed on terrestrial insects, zooplankton |
| Juvenile Emigration | Delta-Estuary to Bay or Pacific Ocean | late June-December | | | diet is <u>Neomysis</u> , <u>Corophium</u> , larval fish, copepods |

Shad spawn where there is a current, over gravel or sand at water temperatures of about 60°F to 75°F (DFG,13,21; DFG,23,3). The distribution and abundance of spawners is influenced by flow. When spring tributary flows are low, the bulk of the run spawns in the main stem of the Sacramento River while spawning in the tributaries decreases (T,XXXIX,14:12-14:22;DFG,13,22). Many shad die after spawning although some do survive to spawn again. It is believed these fish return to the tributary where they initially spawned (DFG,23,8).

After shad spawn, the fertilized eggs sink and drift with the current until hatching about 4-6 days later (SWRCB,405,41). When river flows are high, more shad eggs are carried further downstream and the importance of the Delta as rearing habitat increases (T,XXXIX,15:13-15). The major shad nursery areas are located in the Feather River below the mouth of the Yuba River, the lower American River, the Sacramento River from Colusa to Sacramento, and the north Delta (DFG,23,8;T,XXXIX,15:3-15:6). Shad nursery habitat is mostly upstream from striped bass nursery habitat (T,XXXIX,49:1-49:3) and overlaps with Chinook salmon rearing areas. In rearing areas upstream from the Delta, young shad concentrate near the water surface, feeding on terrestrial insects that drop into the water from riparian vegetation (SWRCB,433,101). From about June through August in the Delta, young shad feed on zooplankton before emigrating as juveniles during September to December (DFG,23,11; SWRCB,450,3-3). Most shad emigrate by the end of their first year (DFG,23,10). However, some may remain in San Francisco, San Pablo, and Suisun bays and Suisun Marsh for a second year or not emigrate to the ocean at all (DFG,23,10-11). According to DFG relatively few yearling shad use the Suisun Marsh (T,XXXIX,46:1-5).

When Delta inflows are greater during the spawning and rearing seasons, shad production increases (Figure 4.5.1.4-1) (DFG,23,17). Higher flows during the spring to early summer may improve shad abundance by: (1) providing more spawning and rearing habitat with a consequent reduction in competition for food; (2) dispersing eggs and larvae over a larger area which also decreases competition; and (3) reducing the proportion of river flow diverted to the export pumps, thereby reducing the number of young shad entrained (T,XXXIX,16:2-17:16).

Millions of young shad, both those spawned in the Delta and migrants from the Sacramento River that have been transported through the Delta Cross Channel, are entrained by the CVP and SWP export pumps (DFG,23,20-21;TXXXIX;17:6-24). Fifty percent or more of the shad collected at the CVP and SWP fish protection facilities die during fish salvage operations (T,XXXIX,17:11-16-18:4;DFG,23,22). Numerous unscreened Delta agricultural diversions also contribute to the mortality of young shad (T,XXXIX,17:4-10). Water diversions during the spawning and rearing season may also reduce shad production by decreasing the abundance of their primary food, zooplankton (T,XXXIX,18:6-18).

FIGURE 4.5.1.4-1 Relationship between average daily April-June inflow to the Delta and fall abundance of juvenile American shad, 1967-1985 (except 1974 and 1979) (from DFG, 23, 19).

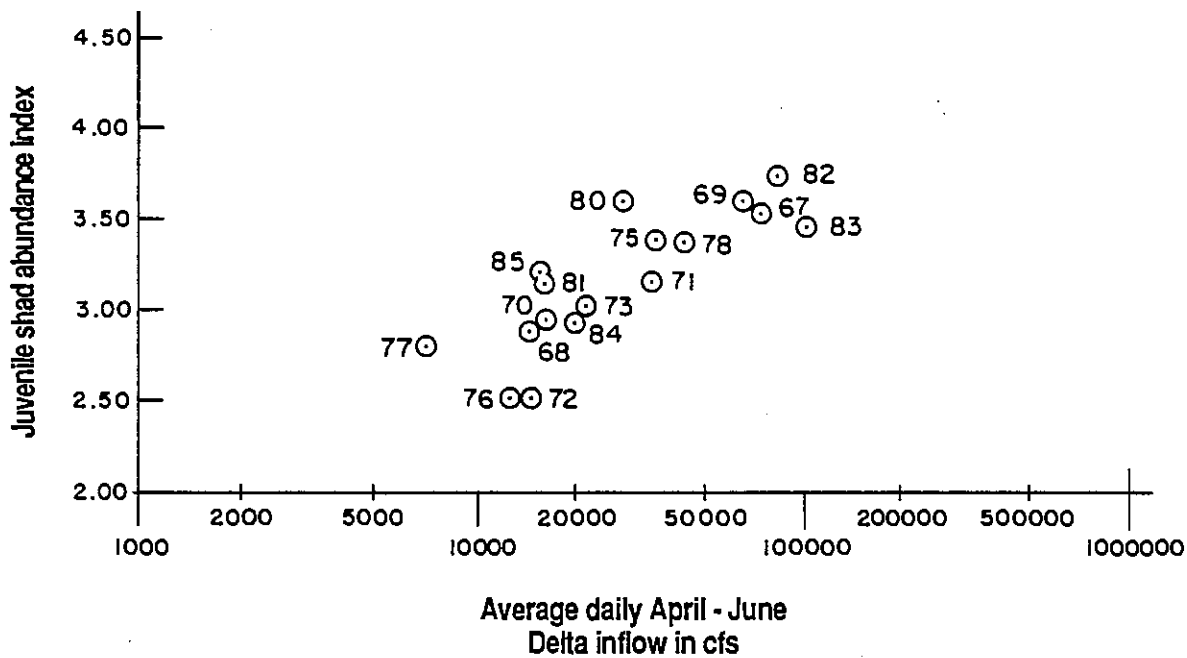

4.5.1.5 Other Resident and Anadromous Fish

There are over 30 species of resident, warmwater fishes in the Estuary (DFG,24,2), more than half of which were introduced. Most resident fish are members of one of three families: Centrarchidae, sunfish; Cyprinidae, minnows; and Ictaluridae, catfish.

● Background

These families support popular recreational fisheries in the Delta. White catfish, Ictalurus catus, are the most commonly caught resident fish, followed by largemouth bass, Micropterus salmoides, and then other sunfish. Sunfish, catfish and largemouth bass are the second, third, and fourth most commonly caught gamefish statewide (DFG,24,5). Non-game resident fish are important components in the estuarine food web both as predators and prey (DFG, 24,6). An important introduced forage species, the threadfin shad, Dorosoma petenense, is consumed by striped bass, largemouth bass and other sunfish (SWRCB,450,3-10).

Relatively little is known about specific flow and water quality requirements of resident fishes of the Estuary (DFG,24,5). The results of a 1980 to 1983 survey by DFG were broadly descriptive but the habitat conditions controlling resident species populations could not be determined (DFG,24,41). Many of the native species were so rarely collected that they could not be statistically analyzed (DFG,24,2). Table 4.5.1.5-1 lists the resident species of the Estuary. Table 4.5.1.5-2 summarizes the regional water quality trends as measured during the DFG survey.

According to DFG, native species were generally associated with the "better water quality" of the northern and western Delta (DFG,24,41), but this could not be confirmed from the information presented. Species abundance and diversity was second highest in the northern Delta compared to the other regions (DFG,24,16). The abundance of several species--the native Sacramento sucker, Catostomas occidentalis; prickly sculpin, Cottus asper; tule perch, Hysteroecarpus traski; Sacramento squawfish, Ptychocheilus grandis; and splittail, Pogonichthys macrolepidotus--was greatest where electrical conductivity (EC) was lowest, mainly in the northern and western Delta (DFG,24,19). However, it is known that the splittail, tule perch and prickly sculpin tolerate brackish conditions. It is therefore possible that other factors may be responsible for their distribution (DFG,24,21-22). The highest abundance and diversity of resident fish was observed in the eastern Delta (DFG,24,18) where introduced species predominated in the sluggish deadend sloughs (see Table 4.5.1.5-2).

According to DFG, Delta water temperatures are within the tolerance range of resident species (DFG,24,39). Warm water fish can tolerate temperatures as high as 86°F. Several native minnows are associated with the cooler temperatures

Table 4.5.1.5-1--Fishes of the Delta (from DFG 24 and SWRCB,450)

Cyprinidae - Minnows

Carassius, auratus, goldfish (I)* +

Cyprinus, carpio, common carp (I) +

Lavinia, exilicauda, hitch (N) +

Mylopharodon, conocephalus, hardhead (N) +

Notemigonus, crysoleucas, golden shiner (I) +

Orthodon, microlepidotus, Sacramento blackfish (N) +

Pimephales, promelas, fathead minnow (I)

Pogonichthys, macrolepidotus, splittail (N) + ^{2/}

Ptychocheilus, grandis, Sacramento squawfish (N) +

Ictaluridae - Catfish

Ictalurus, catus, white catfish (I) +

Ictalurus, melas, black bullhead (I) +

Ictalurus, nebulosus, brown bullhead (I) +

Ictalurus, punctatus, channel catfish (I) +

* I=introduced, N=ative + indicates species collected in DFG's 1980-1983
electrofishing survey

1/ Species of special concern being considered for endangered species status

Table 4.5.1.5-1--contd.

Centrarchidae - Sunfish

Lepomis, cyanellus, green sunfish (I) +

Lepomis, gibbosus, pumpkinseed (I) +

Lepomis, gulosus, warmouth (I) +

Lepomis, macrochirus, bluegill (I) +

Lepomis, microlophus, redbreast sunfish (I) +

Micropterus, dolomieu, smallmouth bass (I) +

Micropterus, punctulatus, spotted bass (I) +

Micropterus, salmoides, largemouth bass (I) +

Pomoxis, annularis, white crappie (I) +

Pomoxis, nigromaculatus, black crappie (I) +

Others

Catostomus, occidentalis, Sacramento sucker (N) +

Hysterocarpus, traski, tule perch (N) +

Menidia, beryllina, inland silversides (I) +

Table 4.5.1.5-1--condt.

Dorosoma, petenense, threadfin shad (I) +
Percina, macrolepida, bigscale logperch (I) +
Morone, saxatilis, striped bass (I) +
Alosa, sapidissima, American shad (I) +
Acanthogobius, flavimanus, yellowfin goby (I) +
Cottus, asper, prickly sculpin (N) +
Leptocottus, armatus Pacific staghorn sculpin (N) +
Oncorhynchus, tshawytscha, chinook salmon (N) +
Salmo gairdneri, gairdneri, steelhead (N) +
Gambusia, affinis, mosquitofish (I) +
Gastrosteus, aculeatus, three spine stickleback (N) +
Lampetra, tridentata, Pacific lamprey (N) +
Lampetra, ayresi, river lamprey (N)
Mugil, cephalus, striped mullet +
Hypomesus, transpacificus, Delta smelt (N) + 1/
Spirinchus, thaleichthys, longfin smelt (N) +
Platichthys, stellatus, starry flounder (N) +
Acipenser, transmontanus, white sturgeon (N)
Acipenser, medirostris, green sturgeon (N)

Table 4.5.1.5-2--Annual Average Water Quality Trends in the Delta
(from DFG,24,15)

| Delta Region | Water Temperature (°F) | Electrical Conductivity (mmho) | Dissolved Oxygen (ppm) | Transparency (cm) |
|--------------|------------------------|--------------------------------|------------------------|-------------------|
| Eastern | 63.1 | 212 | 8.8 | 50.5 |
| Northern | 61.5 | 197 | 9.7 | 61.4 |
| Western | 61.7 | 353 | 9.6 | 46.6 |
| Central | 62.1 | 316 | 9.0 | 55.3 |
| Southern | 62.8 | 460 | 9.0 | 44.0 |

more typical of the northern and western Delta (DFG,24,39), (see Table 4.5.1.5-2). Except in localized areas, dissolved oxygen (DO) concentrations at or below the lethal level of 3 ppm were not observed (DFG,24,40-41). The DFG study concluded that resident fish abundance could not be correlated with Delta water temperatures or DO levels (DFG,24,39).

- Sunfish

Sunfish were most abundant in the eastern Delta in habitats with slow currents such as deadend sloughs, oxbows, and sheltered channels and embayments (DFG,24,29); with abundant riparian and/or aquatic vegetation (DFG,24,41-42); and with an abundance of zooplankton (DFG,24,22-23). Sunfish are carnivorous and eat everything from zooplankton to young-of-the-year striped bass (DFG,24,3;SWRCB, 433,145-152). They spawn in shallow water during the spring and summer when water temperatures range from 57° to 75° F (DFG,24,3). Aquatic vegetation is used as cover by all life stages (DFG,24,34).

The only native sunfish, the Sacramento perch, Archoplites interruptus, has disappeared from the Delta, probably due to competition with introduced species and habitat destruction (DFG,24,22). This species was once very widespread and abundant in the waters of the Central Valley floor but is now found only in artificial impoundments where it has been introduced (SWRCB,433,17).

- Minnows

Three species of introduced minnows--the carp, Cyprinus carpio; the goldfish, Carassius auratus; and the golden shiner, Notemigonus crysoleucus--have come to dominate the five species of native minnows (see Table 4.5.1.5-1)(DFG,24,4). The introduced minnows are abundant in the slow water of sloughs and sheltered channels, particularly in the eastern Delta (DFG,24,29).

In an earlier study (SWRCB,433,154), the introduced goldfish and carp, as well as the native Sacramento blackfish, Orthodon microlepidotus and Sacramento hitch, Lavinia exilicauda, were most numerous in the southern Delta at Mossdale on the San Joaquin River, and were also associated with high concentrations of dissolved solids, an indication of elevated salinity typical of areas receiving agricultural drainage. In the present study, goldfish, carp, and Sacramento blackfish were associated with higher salinity habitats in the Delta (DFG,24,28).

The native minnows have diverse feeding habits. The splittail eats Neomysis in the Estuary and amphipods and clams in the Delta (SWRCB,407,53); blackfish feed on phytoplankton and organic detritus; the hitch, zooplankton, and the squawfish, other fish (SWRCB,407,53). The introduced minnows eat small insects, zooplankton and plant material (SWRCB,450,10-4,10-6,10-15).

- Catfish

Of the four species of introduced catfish (see Table 4.5.1. 5-1), the white catfish, by far the most numerous (DFG,24,4) supports a significant recreational fishery. In the southern Delta where EC and turbidity were greater, white catfish were the most numerous resident fish species (DFG,24,28). The breeding behavior of all four species is similar, spawning in the spring and summer when water temperatures reach or exceed 70°F (SWRCB,405,22-27). They are omnivorous (DFG,24,4), but the amphipod, Corophium, was found to be their primary food (SWRCB, 433,131-143). According to the DFG survey, white and channel catfish, Ictalurus punctatus, are abundant in the turbid riverine and open slough habitats of the south Delta where EC rises as agricultural runoff increases during the summer.

- Other Anadromous Species

Several other native, anadromous fish use the Delta as a migration corridor and nursery habitat. They are the green sturgeon, Acipenser medirostris; the white sturgeon, Acipenser transmontanus; and the steelhead rainbow trout, Salmo gairdneri gairdneri. Other than information presented in SWRCB exhibits, no testimony or recommendations were made in Phase I of the hearing regarding these species' use of the Delta.

Little is known about either the white or green sturgeon. Adults of both species migrate through the Bay-Delta to upstream spawning areas (SWRCB,405,38). White sturgeon migrate from the late winter through early spring. Most spawning occurs between February and May (SWRCB,407,46) in the Sacramento River upstream of its confluence with the Feather River. Larvae are present from late February to early June. Following spawning, adults return to the Bay and Delta where they remain, feeding on benthic invertebrates, Bay shrimp and herring. Green sturgeon are believed to spend more time offshore, traveling up and down the coast (SWRCB,430,452-453). Juvenile sturgeon live year round in the Delta, eating American shad, Corophium, Neomysis, and other species of benthic invertebrates and shrimp (SWRCB,433,120-122).

An intense commercial sturgeon fishery existed in the 1800's. It was closed in 1901 after the catch plummeted. The fishery reopened in 1910, was closed in 1917, and only reopened for recreational purposes in 1954 (SWRCB,430,453). Angling is popular in the Sacramento River up to Colusa, the Delta (SWRCB,405,35-36), and the bays. Sturgeon are taken in San Francisco Bay where they congregate to feed during the herring runs (SWRCB,430,454). Party boats reportedly harvested 2,400 sturgeon in 1967. There is no information on the recent magnitude of the recreational fishery.

Adult steelhead migrate upstream from the ocean during the spring through fall. Spawning occurs from December through April in tributaries above the Delta. Like salmon, steelhead return home to their natal stream; unlike salmon, not all adults die after spawning. Steelhead are known to have spawned up to four or more times (SWRCB,405,60; SWRCB,450,5-7). There are several seasonal runs of steelhead migrating through the Delta (SWRCB,405,59-60;SWRCB,450,5-6). The size of the recreational fishery for steelhead adults and juveniles is unknown.

Juvenile steelhead rear in freshwater habitats for one to three years (DFG,13,21). Because they require flows to maintain adequate habitat during this period and much of their original upstream habitat is no longer available, natural steelhead populations have declined (SWRCB,407,48). Hatcheries in the upper Sacramento, Feather, American, and Mokelumne rivers now produce many of the steelhead occurring in the Bay-Delta (SWRCB,450,5-7;SWRCB,407,48). During their downstream migration through the Bay-Delta Estuary in the spring (April-May) and fall, juvenile steelhead feed on Corophium, terrestrial and aquatic insects, crustaceans, and fish (SWRCB,433,113; SWRCB,450,5-7).

- Species of Concern

The splittail is one of two species of special concern because its distribution is restricted to the Bay-Delta Estuary and it has recently declined in abundance (USFWS,35,1). The other, the Delta smelt, Hypomesus transpacificus, once abundant in Suisun Marsh and the Delta, has undergone a precipitous decline since the early 1970's (USFWS,35,20). Both fish have been recommended as candidate species by the USFWS to be studied to determine whether they should be added to the federal endangered and threatened list (USFWS,35,11).

Resident fish are subject to entrainment by the SWP and CVP Delta pumping plants. Between 1978 and 1985 an average of 330,000 white catfish and 810,000 threadfin shad were entrained annually at the SWP, with the highest numbers during the summer (DFG,24,35-36). Species inhabiting open

¹⁷ Listing refers to a process established under state and federal Endangered Species Acts by which native species are identified. Those listed are determined to be in immediate jeopardy of extinction ("Endangered") or to be present in such small numbers throughout their range that they may become endangered if their present environment worsens (rare plant or threatened species) (California Fish and Game Code Sections 1901, 2062, 2067 and 2068; 16 USC.Section 1531, et seq.)

water or more riverine habitats are thought by DFG to be more vulnerable to diversion and entrainment than fish inhabiting dead end sloughs and other backwater areas. However, since the size of resident fish populations is unknown, it cannot be determined what effect losses caused by water diversions may have (DFG,24,36).

The information on resident freshwater species and other anadromous fish presented in the Phase I hearing was mostly descriptive. No quantitative data were presented on the relationship between population abundance and distribution and flow or salinity regimes. In the absence of such information no water quality objectives can be developed. Therefore, there will be no further discussion of these species in the following chapters of this report.

4.5.2 Bay Habitat

Suisun, San Pablo, San Francisco and south San Francisco (south) bays and consider here. Since, for this Plan, Suisun Bay is considered to be part of the Bay, it is included here for purposes of discussion (see Section 4.5.1.1).

4.5.2.1 Phytoplankton and Zooplankton

As in the freshwater portions of the Estuary (Section 4.5.1.1), phytoplankton and zooplankton form important parts of the food chain in the more saline portions of the Estuary. Extensive testimony was presented concerning three major issues. The first is the need for Delta outflows to position the entrapment zone in Suisun Bay in particular locations, and to stimulate growth of phytoplankton and zooplankton (including the opossum shrimp) to provide food for young striped bass and other fish species. As noted in the discussion of the Delta (Section 4.5.1.1), there have been numerous changes in the Bay in recent years. A second factor is the periodic intrusion of freshwater or estuarine benthic organisms into Suisun Bay under different outflow conditions (T,LXII,58:22-59:11;68:3-16), and their possible impacts on phytoplankton abundance. A third is the recently reported introduction of a new species of benthic bivalve (Potamocorbula amurensis, Family Corbulidae) which further complicates attempts to understand the biology of Suisun Bay.

Some Phase I hearing participants proposed objectives to maximize phytoplankton production, locate the entrapment zone in particular positions, and prevent intrusion of marine benthos into Suisun Bay (see, for example, CCCWA/EDF Exhibits 1 and 2). However, much of the evidence was challenged by other participants (see, for example, USBR rebuttal, T,LXII,65:18-75:9).

In the absence of definitive data to draw on, these positions cannot be resolved. However, it would appear that proposed Delta outflow objectives to protect other beneficial uses, especially outmigration of striped bass larvae and salmon smolt,

are generally consistent with those outflows volumes required for protection of certain Suisun Bay aquatic resources. Some of the proposed objectives are also contradictory. Proposing, for instance, an objective to protect one food chain for striped bass, namely by stopping the intrusion of benthic organisms, has an immediate negative impact on the food chain of demersal (bottom-feeding) fish such as sturgeon. No evidence was presented that established there would not be negative impacts on these fish.

The second issue was the proposal to provide sufficient freshwater inflow to develop an entrapment zone in San Pablo Bay similar to that seen in Suisun Bay. The benefit of this second entrapment zone was intended to be additional production of phytoplankton, a concept proposed by witnesses for CCCWA/EDF based on their interpretation of USGS, USBR and other data. They presented evidence to suggest that, at Delta outflows of 10,000 to 20,000 cfs, an entrapment zone forms in Suisun Bay and an apparent second entrapment zone (or at least an area with "stratified flow...with a strong horizontal salinity gradient") forms in San Pablo Bay (CCCWA/EDF,3,23). This position was challenged by USBR in their rebuttal testimony and exhibits (T,LXII,75:10-87:12).

The evidence for the presence of a second entrapment zone is not conclusive. In addition, no compelling evidence was presented to demonstrate a benefit to populations of fish or invertebrates if such an entrapment zone did develop in San Pablo Bay.

The third major issue concerned the merits of setting objectives to cause a stratification of the South Bay by introduction of freshwater inflow, either by month-long periods of high winter or spring outflow or by short periods of large storage releases at specified times (i.e., pulse flows). It was proposed that these flows would enhance phytoplankton production in the South Bay (CCCWA/EDF,4). USGS testified that they have observed a correlation in South Bay among freshwater inflow, density stratification, and rapid development of phytoplankton blooms (T,LI,179:2-23). Their research also showed that the clam, Macoma balthica, tended to show increases in growth rates consistent with availability of microalgae, including phytoplankton (T,LI,181:20-182:15). These and other data were used as the basis for the CCCWA/EDF proposal. However, it was noted that the clams responded not just to increases in phytoplankton, but also to increases of periphyton, microalgae growing in the sediment (T,LI,238:1-22). In addition, these phytoplankton blooms have not been shown to have effects on zooplankton abundance. There is also no evidence to conclude that increases in zooplankton or benthos are likely to yield increases in fish populations in the South Bay. USGS noted that in other estuaries a relationship between phytoplankton production and fisheries production had been demonstrated, but to their knowledge, no such relationship has been demonstrated for San Francisco Bay (T,LI,180:9-181:11; 192:10-17).

Like that for the Delta, the evidence presented is not sufficiently definitive to develop specific objectives for the protection of phytoplankton and zooplankton in Suisun, San Pablo, San Francisco and South bays. It is anticipated that freshwater inflow resulting from flows to protect beneficial uses in these areas or upstream may also provide protection for estuarine phytoplankton and zooplankton. Should additional evidence indicate that these aquatic resources are not being protected, and the evidence is sufficiently definitive to propose objectives, this issue may be reexamined at a later date.

4.5.2.2 Benthic Invertebrates

"The 'benthos' is the community of invertebrate animals (worms, clams, shrimp, etc.) living on the bottom of aquatic environments. These animals consume organic matter that grows on, or settles to the bottom and in turn become food for fish and other consumers including humans" (TIBCEN,23,65). Benthic invertebrates in the Estuary tolerate a range of salinities; some prefer different flows and salinities at different life stages (DFG,59,14). There are species requiring only freshwater, species requiring a combination of salt and freshwater, and those surviving only in saltwater. For example, some species such as the commercially valuable starry flounder (Platichthys stellatus) prefer fresher water during early life stages and as juveniles are found in the upper reaches of the estuary, whereas adults prefer higher salinities and occupy the Bay (DFG,59,22). Adult shrimp occupy bottom areas in their preferred habitat, while shrimp larvae are found in less saline surface layers. These behavioral differences, combined with the effects of the two-layered flow in the Bay (see 3.6.2.1) result in different distributional patterns of young and old shrimp (USBR,110,15). For example, Crangon shrimp breed in the Bay, produce planktonic larvae which may be carried into the ocean near shore by surface water, drop down as benthic post-larvae and reenter the estuary carried by gravitational circulation (DFG,59,23). Gravitational circulation also strongly affects the distribution of bottom-dwelling species like speckled sanddab and English sole larvae (DFG,59,24).

The following benthic organisms found in the Estuary are part of the food chain which support popular sport or commercial fisheries and wintering waterfowl:

- mollusks, including clams (Macoma balthica, Mya arenaria, Tapes japonica, Gemma gemma, Corbicula spp.), mussels (Ischadium demissum, Mytilus edulis), oysters (Ostrea lurida), and snails (Nassarius obsoletus);
- arthropods, including amphipods (Corophium, spp. Grandidierella japonica, Ampelisca milleri), shrimp (Crangon spp.), and crabs (Cancer spp.); and

- worms (Limnodrilus spp., Boccardia ligERICA, Streblospio benedicti) (Markmann, 1986).

There is a pronounced "faunal break" west of Suisun Bay, where freshwater and brackish water species give way to salt-tolerant species found in San Pablo Bay (DFG,59,12).

Densities of benthic organisms are highly variable in the Estuary. At any location their survival and growth can be affected by factors such as predation, disease, parasites, currents which carry them away, salinity regime, and broodstock population size (DFG,60,57). Density estimates^{1/} as high as 910 to 1153 grams per square meter (g/m^2) are reported in South Bay channels, to as low as 4 to 17 g/m^2 in the channels of San Pablo Bay; Suisun Bay has benthic invertebrate biomass ranging from 25 to 34 g/m^2 in channel substrates and from 6 to 30 g/m^2 in shoal areas (CCCWA/EDG,10,T2). The number of organisms varies much more than the biomass, with a few large animals sometimes equalling the biomass of many smaller ones. At the Carquinez Strait, this biomass was made up of about 160,000 and 40,000 organisms/ m^2 in June and October of 1976; 25,000 organisms/ m^2 in March of 1977; but by less than 1,000 organisms/ m^2 in October 1977 and in 1978 (Markmann,1986,F8-F11). Organism numbers per m^2 at all stations were low in 1978; numbers appeared to recover to about 40,000 organisms/ m^2 in the western Delta (Station D4) in 1979 and 1981, although Carquinez Strait stations were no longer sampled (Markmann, 1986, F8-F11). The brief peak in organism numbers in 1976 and 1977 during a major drought was due in part to an invasion of Suisun Bay by the filter-feeding clam, Mya arenaria, which replaced the usual deposit-feeding fauna (CCCWA/EDF,7,383).

The benthic grazing hypothesis was formed to explain the high numbers of these (e.g., Mya arenaria) more saline tolerant filter feeders (a ten-fold increase when compared to non-drought conditions) and the low phytoplankton and zooplankton populations during the 1976-1977 drought (CCWA,EDF,7,385). In Suisun Bay, the benthic salt-tolerant, filter-feeders apparently became large enough and sufficiently abundant to be capable of filtering the entire volume of the Suisun Bay in a day. With this amount of feeding, it is hypothesized that benthic filter-feeders consumed virtually all phytoplankton and nutrient material in the water column. The pelagic (open-water) food web, which is also based on phytoplankton, was therefore replaced by the benthic food web (CCCWA/EDF,7,386). However, it appears that marine benthic organisms which do invade during dry periods will be virtually wiped out during years of high flow. In the same way,

^{1/} Abundance or density of benthic organisms measured by biomass per square meter

freshwater filter-feeding organisms will be eliminated during drought. Under unimpaired rainfall and runoff conditions, the Suisun Bay normally receives enough fluctuation in salinity to prevent either marine or freshwater filter-feeding benthic organisms from surviving for more than a few months (SWRCB,105). This fluctuation in conditions provides a habitat which is uniquely suited to an open-water food web based on phytoplankton and zooplankton.

One of the consequences of water project operations under D-1485 is that salinity fluctuations in the Estuary are reduced under most flow conditions (SWRCB,102,A-K;SWRCB,103,A-C). Variability of habitat in the bays and estuaries normally increases the number of species (DFG,59,9-10). Under the more stable conditions of salinity which result from operations under D-1485, a reduction in habitat and species diversity can be expected. At present, with existing storage facilities and diversion capability operated according to D-1485, there are still a large number of pulses of freshwater outflow during above normal and wet years (LIII,199:13-17;DWR,654;DWR,655). DFG concluded that reductions in either annual outflows or pulse flow levels could result in more intraspecific competition and reduce recruitment into the adult population, but that more field observation than the six years of field sampling to date should be used to test whether their conclusion was correct (DFG,59,30).

Because substantial variation in freshwater outflow from the Delta will continue to occur with existing water project operations, and because of the lack of testimony or evidence linking the abundance of other fish and wildlife to the benthic organisms, no objectives are proposed specifically to control or enhance the benthic community. If data become available that relate freshwater outflow to changes in the benthos and other aquatic communities of organisms, may be reviewed.

4.5.2.3 Fish

Studies of San Francisco Bay fish required by the 1978 Delta Plan (T,LI,249:10-24) were initiated by DFG in January 1980 (T,LI,251:20-24) to "document the importance of flow to Bay resources...and determine...the ecological benefits of unregulated outflows and salinity gradients established by them". (DFG,59,29).

In reporting that "sport fishing is the most popular recreational activity in the San Francisco Bay and Delta area," DFG estimated that 4.4 million recreation days were used in this activity, with a much larger, as yet undeveloped potential demand existing (DFG,59,10). Striped bass, Chinook salmon, and halibut are the most popular species caught in the Bay; other sport species include brown rockfish, surf perch, lingcod, jacksmelt, topsmelt, white croaker, shark, ray and skate.

The commercial harvest of finfish in the Bay has been limited by legislation (T,LII,19:3-20), with only herring and anchovy being taken commercially today(DFG,59,11). The herring fishery is primarily for roe which is exported to Japan. English sole, which use the San Francisco Bay as a nursery, are an important offshore commercial species. Anchovy are harvested primarily for bait. DFG estimated the commercial harvest of herring roe and shrimp from San Francisco Bay landings to have a value of \$11.6 million per year (H.Chadwick,pers.comm.,12/28/87).

DFG was unable to establish any relationship between freshwater outflow and the size of commercial catches because of significant problems with the data base, among which were: (1) inconsistent catch reports; (2) a commercial fishery with changing equipment, methods and territory; (3) catch reporting methods which make it difficult to determine catch location; (4) the species fished as well as the size of the catch being determined primarily by the market place rather than species abundance; and (5) life history information not being known for most commercially harvested species (DFG,60,318).

In Phase I of the hearing, DFG presented much new descriptive information about the effects of flow on individual fish species and the abundance and distribution of their life stages in the Bay. This is a necessary first step in describing the beneficial use of Bay fish. However, the information needed to establish numerical flow or salinity objectives for the protection of Bay finfish resources downstream of the entrapment zone was not presented. (Delta outflows needed to protect anadromous fish and/or the entrapment zone are discussed in Section 5.3.4.3). Numerical objectives cannot be set without considerable additional study (T,LII,25:17-24;T,LII,38:8-14;T,LII,45:12-24;T,LII,67:13-17;T,LII,74:6-13).

Patterns of Bay fish abundance and distribution, and their relationship to freshwater outflow were highly variable and were influenced by offshore as well as upstream processes. Studies from other estuaries confirm what the DFG studies indicated, that "{i}n some cases, the same flow changes favor some organisms, while negatively impacting others" (DFG,61,73). Also, "{t}here may be some level of [inflow] reduction that causes serious impacts in each system but certainly that level varies among systems and...species." (DFG,61,77). DFG postulated that the extreme variability of Bay conditions is normal and contributes to the productivity of the system (T,LII,4:13-25). Among the reasons for the diversity of responses observed by DFG are: (1) a constantly shifting community of fish species; (2) the hydrologic and biologic environment of the Bay not being isolated from oceanic influences; and (3) the very limited historical database on Bay finfish.

DFG collected 122 fish species and about 1,642,000 individual fish, including larvae, during a six-year study, from January 1980 through December 1985 (DFG,59). Most species were so rare

they were not analyzed further. Bottom (demersal) habitats supported a more abundant, diverse fish community than open water (pelagic) or nearshore areas (DFG,59,6). Table 4.5.2.3-1 identifies the predominant species in each of these areas.

DFG analyzed the abundance of the 69 most common species in relation to DWR's water year classification system. During the study period there were four wet years (1980, 1982, 1983, and 1984) and two dry years (1981 and 1985) with a wide range of freshwater outflows (DFG,60,3)(see Figure 4.5.2.3-1). The abundance of 61 percent (42 species) showed no consistent change with water year type, 29 percent (20 species) increased in wet years and 10 percent (7 species) increased in dry years (DFG,59,19-20). This method of analysis produced only a very general idea of species' response to outflow since DFG did not relate fish numbers to monthly flows (T,LII,37:11-12).

Thirteen species occurred in numbers sufficient to warrant more detailed analysis (DFG,60) (see summaries in Tables 4.5.2.3-2 and 4.5.2.3-3). Of these, twelve were native species and one was introduced. All of the predominant species use the Bay during their life cycle (see Table 4.5.2.3-2)(DFG,59,10). Many of the species which are prey for other fish or birds are permanent residents of the Bay, including gobies, topsmelt, and Pacific staghorn sculpin. The Bay also provides nursery and rearing habitat for species which are harvested commercially and recreationally (see Table 4.5.2.3-2). For example, the English sole and starry flounder spawn off shore but their eggs or young are carried by gravitational circulation into the Bay where they mature. Adults of other commercially important species such as Pacific herring and northern anchovy actively move into and spawn in the Bay where their young also mature (DFG,59,10).

DFG also examined fish abundance relative to salinities ranging from 0 to 35 ppt salinity. Nine species preferred more saline areas, among them Pacific herring, English sole, several gobies and northern anchovy. Four species, yellowfin goby, Pacific staghorn sculpin, longfin smelt, and starry flounder, tolerate a broader range of saline conditions (DFG,59,7-10;DFG,60,121,210,280-283). Salinity preference appears to change with age in some species; for example, young starry flounder and Bay gobies prefer fresher water while older fish prefer more saline environments (DFG,59,22). The distribution of different life stages may change with shifts in salinity. For example, during wet years, juvenile English sole do not use San Pablo Bay but in dry years when salinity is higher they do (DFG,59,22). When marine waters penetrate upstream, marine fish species follow. During the drought (1976-77), freshwater species moved out of Suisun Marsh and marine species moved in (DFG,61,46).

No uniform response to Delta outflow was evident among the 13 most abundant species (DFG,59,13-28). DFG reported that some species or life stages increased in abundance and/or expanded their distribution during increased freshwater outflows while others did not (see Table 4.5.2.3-3). No consistent

Table 4.5.2.3-1 Most Common Bay Fin Fish Collected from Demersal, Pelagic, and Nearshore Areas by DFG, 1980-1986 (from DFG, 59, 6)

SHORE HABITAT

Atherinops affinis
topsmelt
Clupea harengus pallasii
Pacific herring
Engraulis mordax
Northern anchovy
Atherinopsis californiensis
jacksmelt
Morone saxatilis
striped bass
Leptocottus armatus
Pacific staghorn sculpin
Menidia beryllina
inland silversides
Clevelandia ios
arrow goby
Cymatogaster aggregata
shiner perch
Micrometrus minimus
dwarf perch
Acanthogobius flavimanus
yellow fin goby

PELAGIC HABITAT

Engraulis mordax
Northern anchovy
Sprinchus thaleichthys
longfin smelt
Clupea harengus pallasii
Pacific herring
Morone saxatilis
striped bass

DEMERSAL HABITAT

Spirinchus thaleichthys
longfin smelt
Engraulis mordax
Northern anchovy
Morone saxatilis
striped bass
Cymatogaster aggregata
shiner perch
Parophrys vetulus
English sole
Genyonemus lineatus
white croaker
Leptocottus armatus
Pacific staghorn sculpin
Leptocottus lepidus
Bay goby
Citharichthys stigmaeus
speckled sanddab
Acanthogobius flavimanus
yellow fin goby
Platichthys stellatus
starry flounder
Clupea harengus pallasii
Pacific herring

FIGURE 4.5.2.3.-1 Average monthly outflow at Chipps Island, 1980-1985
(DFG, 60, 3)

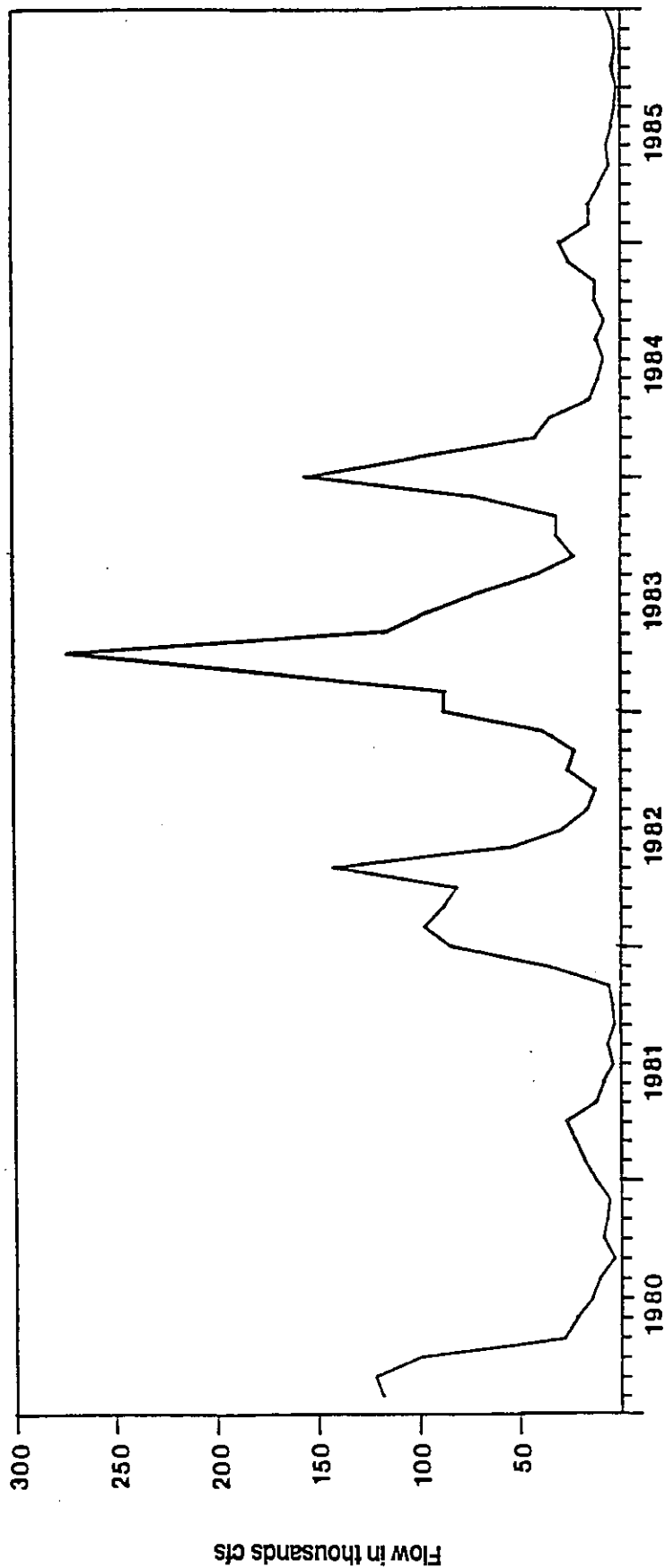

TABLE 4.5.2.3-2 Life history and descriptive information for the most abundant species of fish collected. (DFG, 59)

| Species | Species origin | Species type | Life history | | | Center of population | Importance of species | Preferred habitat | Use of bay | Life stage major food source | |
|-----------------------|----------------|--------------|-----------------|-------------------|--------------|----------------------|-----------------------|--------------------|-------------------|------------------------------|----------|
| | | | Spawning time | Spawning location | Nursery area | | | | | Adult | Juvenile |
| | | | | | | | | | | | |
| Pacific herring | N | M | Fall-Winter | Bay | SSFB-SPB | Ocean | Commercial Forage | Pelagic | Spawning Nursery | P | P |
| Longfin smelt | N | E | Winter | Rivers | SPB | SPB | Forage | Pelagic | Nursery Residence | P | P |
| Pac. staghorn sculpin | N | E | Winter | Bay | Bay | CSFB-SPB | Forage | Demersal | Residence | F, B | B |
| Starry flounder | N | E | Winter | Ocean | SB-Delta | Ocean-Bay | Commercial Recreation | Demersal | Nursery Residence | B | B |
| Speckled sanddab | N | M | All Year | Ocean | Ocean-CSFB | Ocean | Forage | Demersal | Nursery Residence | B | B |
| English sole | N | M | Winter | Ocean | Ocean-Bay | Ocean | Commercial | Demersal | Nursery | B | B |
| California tonguefish | N | M | Summer - Fall | Ocean | Ocean-CSFB | Ocean | Forage | Demersal | Nursery | B | B |
| Yellowfin goby | I | E | Winter | Bay | SB-Delta | SPB-SB | Forage Commercial | Demersal | Residence | B | B |
| Arrow goby | N | M | Spring - Summer | Bay | SSFB-SPB | SSFB-SPB | Forage | Demersal | Residence | B | B |
| Bay goby | N | M | Summer - Fall | Bay | SSFB-SPB | CSFB | Forage | Demersal | Residence | B | B |
| Topsmelt | N | M | Summer | Bay | SSFB-CSFB | SSFB | Forage | Littoral / Pelagic | Residence | B | B |
| Jacksmelt | N | M | Spring - Summer | Bay - Ocean | SSFB-CSFB | Ocean | Recreation Forage | Pelagic | Spawning Nursery | F | P |
| Northern anchovy | N | M | Spring - Summer | Ocean | Ocean | Ocean | Commercial Forage | Pelagic | Spawning Nursery | P | P |

N = native, I = introduced, E = estuarine, M = marine, SSFB = South San Francisco Bay, CSFB = Central San Francisco Bay, SPB = San Pablo Bay, SB = Suisun Bay, P = plankton, B = benthos, F = fish

TABLE 4.5.2.3-3 Relationship between freshwater outflow and abundance and distribution of various life stages of the most abundant fish. (DFG, 59)

| SPECIES | LIFE STAGE | ABUDANCE CHANGES WITH INCREASING DELTA OUTFLOW | | | | IN BAY DISTRIBUTION CHANGES WITH INCREASING DELTA OUTFLOW | | | |
|-----------------------|-----------------------------|--|--------|--------|------|---|----------|-------|-------------|
| | | Winter | Spring | Summer | Fall | Expand | Decrease | Shift | No change |
| Longfin smelt | larval juvenile adult | + | + | | | x x x | | | |
| Pacific herring | larval juvenile adult | | | | | | x x | | x |
| Northern anchovy | larval juvenile adult | | | | | | x x | | x |
| Pac. staghorn sculpin | larval juvenile adult | - | | + | | x | x | | x |
| Starry flounder | juvenile adult | | + | + | | x | | | |
| English sole | larval juvenile | + | - | | | x | x | | |
| Speckled sanddab | juvenile adult | | + | + | | | | | x x |
| California tonguefish | juvenile adult | | + | + | | x x | | | |
| Yellowfin goby | larval juvenile adult | - | + | + | | x | x | | x |
| Arrow goby | larval juvenile adult | | | | | | | | x x |
| Bay goby | larval juvenile adult | + | + | - | - | | x | | x x |
| Topsmelt | larval juvenile adult | | | | | | x x | | x |
| Jacksmelt | larval juvenile adult | | | | | | | | x x x |

relationship was observed between fish abundance and pulse flows (DFG,60,293). Monthly sampling was inadequate to determine the effects of short-term pulses (DFG,60,308). Freshwater pulses temporarily affected fish distribution, more widely dispersing estuarine species of the upper water column. The distribution of demersal species was less affected by pulse flows (DFG,60,296).

According to DFG, the juveniles of estuarine species (see Table 4.5.2.3-2) as well as the juveniles and adults of several flatfish species were generally more abundant during wetter conditions (DFG,59,15). Fish abundance appeared to be mostly associated with increases in Delta outflow for specific life stages of seven species during the spring or summer and three species during the winter (see Table 4.5.2.3-3). Increasing Delta outflows associated with increased abundance or distribution for a particular species in one season or life stage were often reversed in another period or life stage. For example, the abundance of larval English sole in the Bay increased during years of high Delta outflow and their range was broader; in contrast, the range of juvenile sole was limited to Central Bay in wetter years and expanded in drier years (DFG,60,248-251). Some life stages exhibited no detectable distributional shift with higher Delta outflows (DFG,59,16-17). The effect of increasing outflow had to be interpreted with respect to each species' life history because the location of a particular life stage influenced its response to changing hydrodynamics.

Winter-spring Delta outflows may play an important, but as yet poorly understood, role in the productivity and biological diversity of the Bay. Peak flow events and gravitational currents may transport nutrients into the Bay and disperse immature fish to estuarine nursery habitat species which DFG reported showed a positive response when Delta outflows increased (DFG,60) include Bay shrimp, several gobies, starry flounder, Pacific staghorn sculpin, longfin smelt, and English sole.

Future studies of Bay fish are needed to identify critical food chain relationships and the flow and water quality requirements of key species. Studies should concentrate on selected species within the Bay community identified as indicators of community viability and productivity.

Although the evidence presented by DFG in the Phase I hearing adds to knowledge of Bay fish, no specific salinity or outflow regimes were identified as being necessary to protect Bay fishery resources. From the available information, it would be premature to do so at this time. However, it should be noted that the Bay fish community appears well adapted to current variations in outflow and salinity and that potential future appropriations that reduce this variability may reduce the productivity of Bay fish and/or their adaptability. Unless it is determined that objectives proposed for the protection of other beneficial uses provide inadequate protection for Bay finfish, no specific objectives will be set for this beneficial use.

4.5.3 Ocean Habitat

Testimony concerning outflows from San Francisco Bay described two main effects on ocean habitat. The first is that the plume of freshwater in the Gulf of the Farallones provides for an abundant amount of marine life and thus serves as a concentrated feeding habitat for fish, marine mammals and birds (T,LIV,152:22-153:1). Two bird species which particularly use this plume area are the Brandt's cormorant and the common murre (T,LIV,154:3-13). The second effect of San Francisco Bay outflow is related to the movement of organisms, especially the larvae and juveniles of finfish and shellfish, into the Bay (T,LI,267:23-268:4). In certain cases, such as for bay shrimp, movement of larvae out of the Bay into the Gulf of the Farallones and their return later in the year is facilitated by higher Bay outflows (T,LI,272:6-19). In some circumstances, pulse flows, and their timing, were shown to be important in the determination of abundance of larvae (T,LI,289:5-25). The larvae or adults of English sole, Dungeness crab, Pacific herring and northern anchovy are transported back into the Bay on the bottom current inflows generated by the lighter, less saline freshwater flowing out of the Bay (see gravitational circulation; 3.6.2.1, south Bay) (T,LI,292:15-25).

The testimony presented general relationships between Bay outflow and the abundance of various species. However, there was no quantification of the relationship between specific levels of outflow and the effects on these species. Testimony from PRBO indicated that studies have not yet been done to relate the size of the plume to the volume of freshwater flowing from San Francisco Bay (T,LIV,155:15-156:6). No relationship has been established between the amount of freshwater outflow and the productivity of the plume (T,LIV,169:18-20;). Likewise, DFG has not yet been able to quantify the relationship between flows and their effects on various species (T,LI,300:5-8). No recommendations were given for any particular volume or timing of San Francisco Bay outflows, nor for any periodicity or volume of pulse flows to provide protection for beneficial uses in the ocean habitat. Any ocean outflows must be viewed in the context of the effects of water flows in the Estuary as a whole. As DFG pointed out, it is not appropriate to attempt to compartmentalize these effects for the ocean alone (T,LI,293:7-17;T,LIII,49:4-13).

Because of the lack of quantifiable data, and the absence of specific recommendations for flows to protect beneficial uses in the ocean habitat, no specific recommendations for flow or salinity will be made for the ocean habitat. If quantitative data become available that relate Bay outflow to ocean habitat, and if a determination can be made that objectives for the Estuary provide inadequate protection for the ocean habitat, this issue may be reviewed again.

4.6 Estuary Wildlife Habitat Beneficial Use

4.6.1 Delta

In the Delta there are 600,000 acres of agricultural land on the leveed islands and uplands, of which 515,000 acres are cultivated; about 7,000 acres are riparian woodland and scrub/shrub vegetation; 7,000 acres are freshwater marsh; 50,000 acres, water surface; 42,000 acres, grasslands and uplands; and about 32,000 acres of the Delta are urban—for a total of 706,000 acres (DFG,6,1). Freshwater marsh and riparian growth provide the habitats which support the greatest diversity of plant and animal species (DFG,6,4). The agricultural areas have supported from 450,000 to 600,000 migratory waterfowl during the winter, with thousands of shorebirds and wading birds making use of the shallows of seasonally flooded fields (DFG,6,4).

Over 230 species of birds and 43 species of mammals occur in the Delta (DFG,6,1). There are also 15 reptile species and eight amphibians reported or thought to occur in the Delta (Delta Wildlife Habitat Protection and Restoration Plan; DFG, USFWS, 1986). Many of these animals are so uncommon they have been identified on official lists of rare, threatened or endangered species by wildlife agencies. Seven bird species are listed by either the state or federal government as threatened or endangered. Two more bird species are candidates for federal listing (DFG,6,3;USFWS,19,20,21). The giant garter snake is a state-listed threatened species as well as a candidate for federal listing as either threatened or endangered (DFG,6,3; USFWS,22). Two mammals, the riparian brush rabbit and the riparian woodrat are candidates for federal listing as threatened or endangered; three invertebrates also are federally listed as threatened or endangered and thirteen plants are listed by federal and/or state agencies as rare, threatened or endangered (DFG,6,3).

In the Delta, wildlife habitat and wildlife are dependent upon water quality and flow in the channels and upon cropping patterns on the cultivated land. Migratory waterfowl in particular use spilled and unharvested corn and other grain crops, especially when Delta islands are allowed to be ponded or flooded for leaching purposes (DFG,6,4). The quality of water available in Delta channels can affect waterfowl and migratory bird use, as they are influenced by the crops planted and leaching frequencies. Fewer grain crops and less frequent flooding would reduce use by waterfowl such as Aleutian Canada geese, tule white-fronted geese, tricolored blackbirds, as well as sandhill cranes which now depend on wet or flooded pasture and cultivated grains (DFG,6,4 and 7). The peregrine falcon may also be affected by changed waterfowl abundance because of the importance of waterfowl in their diet (USFWS,17,2).

Swainson's hawk, black rail, yellow-billed cuckoo, riparian brush rabbit, riparian woodrat and giant garter snake are species which would be affected by changes in water quality and flow to the degree that such changes lead to contamination of, or a reduction in, the natural habitat of the Delta (T,XXX,5:23-25). Vegetation changes which reduce the acreage of freshwater marsh and riparian forest or scrub/shrub would also have an adverse effect.

4.6.2 Suisun Marsh

Suisun Marsh, with an area of 116,000 acres, is the largest contiguous brackish water marsh in the United States (T,XXX,12;DFG,5,1). The major habitat types are managed marsh, subject to controlled inundation and drainage (generally for the enhancement of waterfowl habitat), and tidal marsh influenced by the water regime in the channels. There are also substantial areas of habitat consisting mostly of annual grasses and weedy growth, cropland and open ground. Between 54,000 acres (T,XXX,110:4-5) and 57,000 acres (DFG,5,3) are marshland, of which approximately 10,000 acres are tidal marsh (T,XXX,49:21,110:5). Estimates differ in regard to what proportion of the marsh acreage is managed and what is tidally influenced, depending on the definitions used and the areas examined. By all estimates the large majority (80 to 90 percent) of marshland is managed for plant species considered beneficial to wintering waterfowl (DFG,5,6).

The principal waterfowl species using Suisun Marsh in winter are pintail, mallard, shoveler, widgeon and green-winged teal; mallard, gadwall, and cinnamon teal breed here. The plants which are preferred food items for wintering waterfowl are alkali bulrush, brass buttons, and fat-hen (DFG,5,9). During the remainder of the year, invertebrates are important food for pre-nesting females and broods of ducklings (DFG,5,13).

Besides waterfowl, several state or federally listed animals and plants exist in the Marsh. Animals include salt marsh harvest mice, clapper rail, and black rail; plants include Mason's lilaeopsis, Suisun aster, Delta tule pea, and salt marsh bird's beak. These animals and plants are likely to be affected by changes in flow and salinity in the Marsh (T,XXX,68:24,136:3-25;BAAC,4). Increased salinity in tidally influenced channels will cause an increased physiological stress on plants, resulting in decreased reproduction and productivity, eventually leading to changes in the plant and dependent community (CNPS,1,5-8). Water quality standards lower than present levels, i.e., higher TDS levels (T,XXIX,210:9-12), will increase plant stress, decrease photosynthetic productivity of marsh plants, kill salt-sensitive species, retard growth of new plants, and reduce plant species diversity (CNPS,1,10).

4.6.3 Other Tidal Marshes

San Francisco Bay's tidal marshes, ranging from fresh to salt habitats, include 53 square miles of tidal marsh, 15 square miles of diked marsh and 55 square miles of diked ponds (DFG,7,1). Major areas of tidal wetland occur on the northeast shore of San Pablo Bay, specifically Tubbs Island, Napa and Petaluma Marsh. Diked marshes, ponds and mudflats are extensive in the south Bay (DFG,7,1).

Bay area wetlands and aquatic habitats support over half of the Pacific Flyway's wintering population of such waterfowl as canvasback ducks and are very important for scaup, scoters and redhead ducks. A variety of species of wildlife listed as threatened or endangered by state or federal wildlife agencies depend on Bay habitats for all or

part of the year. Salt marsh harvest mice, California clapper rail, black rail, California brown pelican, and California least tern are listed (DFG,7,13). In Bay marshes, salt marsh bird's beak and Mason's lilaepsis, are listed by the state as rare plants. Both plants are dependent on brackish or salt marsh conditions (T,XXX,70:19-23;T,XXX,76:5-22) and occur near the upper reaches of the Bay.

Aquatic habitat and aquatic invertebrates are important in their contribution to the food supply of higher forms of Bay wildlife. One of the most important food items for canvasback ducks is the clam Macoma balthica and two other molluscs, Mya arenaria and Musculus senhousia are also extensively eaten. These molluscs are also food for clapper rail, as are a variety of other invertebrates (DFG,7,9).

Although many Bay tidal marshes are relatively isolated from Delta outflow and salinity, the nearby Bay waters are affected by stratification, gravitational circulation, and flushing induced by outflow. To the degree that mollusc and fish species and aquatic habitat productivity changes in the Bay, the value of the adjacent marshes and beaches for sensitive wildlife, such as rails, terns, and pelicans, may change (DFG,7,10-12).

4.7 Estuary Recreation Beneficial Use

The waters of the Estuary are used for a variety of contact and non-contact forms of recreation, among them, swimming, boating, fishing, hunting, water skiing, and houseboating. The waters are also used for competitive events, marine parades and emerging activities, such as boardsailing and jetskiing (EBRPD,1-33). There are also a variety of water-oriented, non-contact activities such as sightseeing, whale-watching, bird watching and beachcombing, all of which depend on the esthetics or visual quality of the Estuary's waters to some degree (EBRPD,1-33).

4.7.1 Sacramento-San Joaquin Delta and Tributaries

Evidence was provided which projected user days and economic values for freshwater recreation in the Delta as compared to similar types of recreation at storage and export reservoirs and facilities (SWC,65,24). Freshwater-oriented recreation in the Delta was estimated to be 8.3 million user days in 1977-78, although this number includes some activities which do not depend entirely on the Delta's waters. Brackish water, ocean and estuary activities were not included in the total (SWC,66,5). Testimony and evidence were also provided which indicated that recreation visits to Estuary shoreline park facilities have been growing rapidly compared to the projections used by SWC, i.e., 122 percent in two years vs. 0.8 percent/year (EBRPD,24,T.1). Millions of user days and daily values of \$20 or more for water use are calculated for recreational use of Estuary water (BISF,38,T4). Flow and salinity objectives which affect those uses, either in the area of origin or in the export area, will have an economic effect, but no testimony or evidence

addressed quantitative effects of particular objectives on recreational uses. An extrapolation of old studies of Delta recreation has generated estimates in the range of 13 million recreation days annually (PICYA,2,51). Testimony by SWC suggested that these estimates were high and should be reduced to 6.95 million. However, no current information, based on recreation use studies, during this decade is available (T,LV,137:13-16).

There is also little evidence of the degree to which the Estuary's water recreation would be affected by flow or salinity. Submittals by SWC argued that recreation in the Delta depends on the surface acreage and has little or no relationship to changes in flow of freshwater (SWC,66,14). On the other hand, there was no evidence given as to the impacts of salinity on corrosion, growth of fouling organisms which might grow on boats moored in the Delta, or the costs of piling replacement if marine boring organisms penetrated further into the Delta as a result of higher salinity or more prolonged intrusion of marine water into the Delta.

4.7.2 Suisun Marsh and Carquinez Straits Area

Some evidence was submitted on the recreational use of the Suisun Marsh or Carquinez Straits area of the Bay-Delta Estuary. BAAC submitted evidence inferring that bird watching goes on in the Suisun Marsh (BAAC,20;26;27). From evidence submitted by EBRPD, estimated recreation at its Contra Costa shoreline facilities (Antioch and Martinez shoreline) has increased rapidly from 1981 to 1987, growing from 84,000 visitors to 287,000 visitors, or about 340 percent in six years (EBRPD,34,T1). Although there is little evidence linking the quantity of recreation in this reach to flow and salinity of the water, both BAAC and EBRPD expressed concern that visitors to these recreational areas would experience losses of the value they place on wildlife and fish resources which might be harmed if flow decreased and salinity increased (T,XXX,45:12-23;T,LV,184:15-25,185:1-2).

The rate of growth of recreational use in EBRPD units with water quality problems, Point Isabel and San Leandro Bay, increased from 71,000 to 487,000 users between 1981 and 1987, an increase of over 680 percent (EBRPD,34,T1). This occurred despite serious heavy metal contamination at these beaches. In comparison, the rate of growth at the nearby, unpolluted Hayward and Miller-Knox shorelines has moved from 21,000 users to 196,000, an increase of 930 percent in the same time. Without specific information on the features which prompt users to attend the various park units, or the measurement method by which use estimates were made, it is probably unrealistic to use these figures to show that visitation and recreational use would be harmed by changes in water flow or salinity. Moreover, it is noteworthy that users did not avoid contaminated sites, and it does not seem reasonable to suppose that a moderate change (of one or two parts per thousand) in salinity would substantially change future recreational use. This might not be true if the change were such as to convert a freshwater beach to saltwater; however, no data are in the record on this subject.

4.7.3 San Francisco Bay and Adjacent Ocean

The Basin Plan for Region 2, the San Francisco Bay Basin, identifies most of the same forms of recreation as the Delta. Recreational uses are also identified for the Pacific Ocean and the San Francisco Bay system and all other surface waters (RWQCB, 2.1975). Water-oriented recreation in the San Francisco Bay area was estimated to total over 127 million user days (BISF, 38, T3).

Evidence was presented that outflow to the Bay and Pacific Ocean and resultant salinity changes may affect recreation, but quantification was not made available. The Basin 2 Plan specifies a salinity standard in ocean waters requiring no significant variation beyond present natural background levels. A significant variation is "defined as any level of water quality which has an adverse and unreasonable effect on beneficial water uses or causes nuisance" (RWQCB 2, 1975, 3-3). Several participants presented testimony to the effect that past flow and salinity changes have impaired recreational beneficial uses, and that future flow and salinity changes could impair them further (BISF, 38, 40, 41, 46; EBRPD, 34). Other parties submitted testimony and evidence which proposed that ecosystem changes in flow or salinity would also adversely affect recreational uses (BAAC, 4; BCDC, 1; BISF, 50, 51; PRBO, 2; TIBCEN, 1, 2).

4.8 Other Beneficial Uses

4.8.1 Navigation

Navigation in the Estuary includes both commercial and recreational activities. There are seven major ports in the Estuary (San Francisco, Oakland, Alameda, Redwood City, Richmond, Stockton, and Sacramento), serving more than 5,000 ships annually (NOAA, 1986, 89); there are also numerous oil transfer terminals located between Richmond and Suisun Bay. In 1984, imports at the Estuary's seven major ports were worth \$10,419,000, while exports were worth \$6,295,000 (NOAA, 1986). Six million tons of cargo have been transported annually in Stockton and Sacramento deep-water ship channels (DWR, 1987, 60). In 1985 there were 143,646 recreational boats registered in the nine counties surrounding San Francisco Bay (NOAA, 1986, 74), and about 82,000 pleasure boats are registered in the Delta area (DWR, 1987, 60). These Delta area boaters are served by more than 8,500 berths, 119 docks and 27 launching facilities (DWR, 1987, 60).

Navigation is enhanced by a network of deepwater channels to the major ports. Extensive dredging is required to maintain these channels; in 1985, for example, nearly 8.6 million cubic yards of material were dredged in the Estuary at a cost of more than \$17 million (NOAA, 1986, 97).

These channels have two major effects on the Estuary. The deeper channels allow increased salt water intrusion into the Estuary (T, LVI, 176: 9-178: 8; DWR, 709, 1-2). This increased salinity may have impacts on other beneficial uses such as recreational boating which

Export

would see greater maintenance costs from hull fouling, corrosion of propellers and structures, and related problems (T,LV,158:1-7). The second effect is the impact of dredging and dredge spoils disposal on water quality (see, for example, T,XLVIII,71:20-102:9). This impact will be discussed in the Pollutant Policy Document.

On the other hand, water quality constraints to protect other beneficial uses may affect navigation. Objectives set for salinity and flow may, for example, influence the costs of maintaining or increasing the depths of existing channels (DFG & USFWS,1980,2-15). Closure of the Delta Cross Channel gates also prohibits recreational boaters from using the Cross Channel as a shortcut between the Sacramento and Mokelumne rivers.

Navigational requirements also have direct effects on the Sacramento River. The 5,000 cfs minimum at Wilkins Slough, just below Tisdale Wier, that the CVP is required to provide (T,I,43:15-21), sustains a minimum flow in the Sacramento River in the absence of other regulations.

The SWP and CVP export pumps currently operate under U.S. Army Corps of Engineers (COE) criteria. Maximum flow rates for Clifton Court Forebay are stipulated for various times of the year (DWR,708,10). Operations deviating from these criteria, such as additional export with the four new SWP pumps now under construction, will require a new permit from the COE (DWR,1982,7).

4.8.2 Dilution of Pollutants

Freshwater flows to dilute pollutant burdens in the Estuary and upstream was the subject of considerable testimony, much of which concerned "flushing flows" to reduce pollutant burdens in south San Francisco Bay. Burdens here tend to be higher because of limited exchange of water between South Bay and the ocean in the absence of substantial freshwater inflows to drive the exchange.

Evidence received on pollutants will be used by Regional Boards 2 and 5 to update their basin plans. The State Board will provide guidance to the Regional Boards in the development of pertinent provisions of these plans and will review and approve Regional Board updates. During the final phase of the hearing, the Board will evaluate whether the source control of pollutants proposed by the Regional Boards is sufficient to protect beneficial uses in the Estuary. The need for dilution or flushing flows through water right amendments may be considered only after all reasonable source control methods have been implemented.

4.9 Uses of Water Exported From the Bay-Delta Estuary

The following sections address water use in the areas of export, that is, the areas defined for purposes of this Plan as being outside the legal boundary of and receive water diverted from the Bay-Delta Estuary.

4.9.1 Municipal and Industrial Uses

The majority of California's population lives in semi-arid areas where population and industrial expansion have exceeded the ability of many communities to meet their water needs with local sources.

Local as well as distant communities have seen the Estuary's waters as a means to meet their needs. Municipal and Industrial (M&I) water exports to local areas outside the Estuary began in 1929 when EBMUD initiated the first export of Delta supplies by diverting Mokelumne River water through its Mokelumne Aqueduct to Alameda and Contra Costa counties. In 1934 San Francisco began diverting water from the Tuolumne River through the Hetch Hetchy Project for use in San Francisco, San Mateo, and Alameda Counties. In 1940 the Contra Costa Canal (CCC), the first unit of the CVP, was completed and began supplying water to the Antioch-Pittsburg area. The City of Vallejo began importing Delta surface water from Cache Slough in 1953. USBR began diverting Putah Creek water via the Putah South Canal to Fairfield and Benicia in 1957. In 1965 the South Bay Aqueduct of the SWP began exporting an interim supply of Delta water from the Delta-Mendota Canal (DMC) to Alameda and Santa Clara Counties. The North Bay Aqueduct Phase II facilities of the SWP divert Delta waters from Barker Slough tributary to Lindsey and Cache sloughs, and connect with the Phase I facilities just west of Cordelia. Water will be delivered to Solano and Napa counties (DWR,207,1-7).

M&I exports:

*local Bay Area exports:
Mokelumne Aqueduct*

Contra Costa Canal

Putah South

South Bay Aqueduct

The first non-local, statewide exports began in 1968 when the federal Central Valley Project began exporting water to the municipalities of Coalinga, Huron and Avenal through the DMC and San Luis Canal (DWR,204,1). In 1971 the SWP's California Aqueduct began exporting water to southern California through the Edmondston Pumping Plant over the Tehachapi Mountains (DWR,207,1-7).

Statewide exports

CVP statewide M&I deliveries are approximately 430,000 AF/yr with a projected delivery in the year 2010 of 1,033,116 AF/yr (Table 4.9.1-1)(USBR,1987). In 1985, SWP statewide M&I deliveries were approximately 1,008,000 AF/yr (Table 4.9.1-2)(DWR,461,1). No estimate of SWP projected deliveries to southern California was presented. Table 4.9.1-3 lists state and federal water transfer facilities and the areas each serve.

Population and economic projections indicate growing M&I water demands. The Department of Finance has estimated that the state population will increase from 27,000,000 people in 1986 to 36,280,000 people in 2010 (DOF,1987). Of this, the population of the six most populated counties in southern California--Ventura, Los Angeles, Orange, Riverside, San Bernardino, and San Diego--are expected to increase from a 1986 level of 15,290,000 people to 20,220,000 in 2010 (SWC,6,7).

pop projections

Table 4.9.1-1
Municipal and Industrial Water Contracts
Central Valley Project
(acre-feet)

SACRAMENTO VALLEY AND AMERICAN RIVER SERVICE AREAS c/

SAN JOAQUIN VALLEY SERVICE AREAS

| Contracting Entity | Contract Maximum a/ | 1986 Deliveries b/ | Projected 2010 | Contracting Entity | Contract Maximum a/ | 1986 Deliveries b/ | Projected 2010 |
|-----------------------------|---------------------|--------------------|----------------|-----------------------------|---------------------|--------------------|------------------|
| Bella Vista WD d/ | 7,000 | 2,060 | 7,000 | Arvin Edison WSD | 500 | 0 | 500 |
| City of Folsom d/ | 22,000 | 15,042 | 22,000 | Arvin Edison (Cross Val.) | 500 | 0 | 500 |
| City of Redding d/ | 21,000 | 10,424 | 21,000 | Broadview WD | 20 | 23 | 20 |
| City/Redding(Buckeye) | 6,140 | 2,320 | 6,140 | City of Avenal | 3,500 | 1,257 | 3,500 |
| City/Redding(Buckeye) | 40 | 40 | 0 | City of Coalinga | 10,000 | 6,000 | 10,000 |
| City of Roseville | 32,000 | 11,591 | 32,000 | City of Fresno | 60,000 | 45,000 | 60,000 |
| City/Sacramento(AnRv) d/ | 326,000 | 71,331 | 227,500 | City of Huron | 3,000 | 828 | 3,000 |
| City/Sacramento(SacRv) d | above | 18,896 | above | City of Lindsay | 2,500 | 2,021 | 2,500 |
| Clear Creek CSD | 10,300 | 1,346 | 6,400 | City of Orange Cove | 1,400 | 422 | 1,400 |
| County of Colusa | 40 | 40 | 40 | City of Tracy | 10,000 | 5,734 | 10,000 |
| Diamond International | 510 | 0 | 510 | Contra Costa WD | 195,000 | 124,386 | 195,000 |
| Diamond International d/ | 425 | 425 | 425 | County of Madera | 200 | 30 | 200 |
| East Bay MUD | 150,000 | 0 | 20,000 | County of Tulare | 1,345 | 1 | 1,345 |
| East Yolo CSD | 9,290 | 0 | 8,860 | Fresno County MW#18 | 150 | 59 | 150 |
| El Dorado ID | 2,875 | 3,006 | 2,875 | Musco Olive Prod. (temp) | -- | 0 | -- |
| El Dorado ID | 7,500 | 1,540 | 7,500 | Pacheco WD | 80 | 12 | 80 |
| Elk Creek CSD d/ | 100 | 96 | 100 | Panoche WD (DMC) | 37 | 18 | 37 |
| Folsom Prison d/ | 4,000 | 1,432 | 4,000 | Panoche WD (SLC) | 63 | 23 | 63 |
| Foresthill PUD | 2,500 | 1,084 | 2,500 | San Benito WD | 8,250 | 0 | 6,680 |
| G.W. Williams | 130 | 0 | 130 | Santa Clara WD | 128,700 | 0 | 117,200 |
| Keswick SD | 500 | 140 | 300 | San Luis WD (DMC) | 140 | 109 | 140 |
| Lake CA (Rio Alto) | 200 | 200 | 200 | San Luis WD (SLC) | 440 | 387 | 440 |
| Louisiana Pacific d/ | 25 | 26 | 25 | State of Calif. | 10 | 10 | 10 |
| Mather AFB (temporary) | 350 | 271 | 350 | Stockton-East WD | 10,000 | 0 | 8,000 |
| Mountain Gate | 350 | 457 | 350 | Tracy Golf Club-CA (temp) | -- | 451 | -- |
| Napa Co. FCWCD | 7,500 | 3,167 | 1,500 e/ | Westlands WD | 10,000 | 5,917 | 10,000 |
| Parks & Recreation d/ | 5,000 | 15 | 15 | | | | |
| Placer Co. Water Ag. d/ | 150,000 | 4,921 | 75,000 | Total San Joaquin | 418,779 | 192,690 | 403,709 |
| Riverview Golf Club d/ | 280 | 280 | 280 | | | | |
| San Juan Suburban WD | 5,600 | 7,840 | 5,600 | Total Sacramento and | 1,425,239 | 431,529 | 1,033,116 |
| San Juan Suburban WD d/ | 33,000 | 23,100 | 33,000 | San Joaquin | | | |
| Shasta County WA | 5,000 | 162 | 2,800 | | | | |
| Shasta CSD | 1,000 | 602 | 1,000 | | | | |
| Shasta Dam PUD | 3,227 | 1,573 | 3,227 | | | | |
| So. Cal. Water Co. d/ | 10,000 | 1,612 | 10,000 | | | | |
| Sacramento MUD | 7,500 | 3,167 | 1,500 | | | | |
| Summit City PUD | 1,170 | 300 | 1,170 | | | | |
| U.S. Forest Service | 10 | 10 | 10 | | | | |
| Total Sacramento and | 1,006,462 | 238,839 | 629,407 | | | | |
| American River | | | | | | | |

- a/ Quantity is a contract maximum or is projected M&I use within a combination M&I/agricultural water service contract.
- b/ Deliveries may include water transferred from other contractors or purchased under provisions of the contract and may therefore be higher than contract maximum.
- c/ Includes Solano FCWCD and Napa Co. FCWCD of Solano Project.
- d/ Contract includes water rights; no payment is made to the United States for water rights water.
- e/ Present use includes City of Napa which will cease when North Bay Aqueduct completed.

Source: USBR, Factsheet: "Exhibits and Testimony before SWRCB, Bay-Delta Hearing, 1987", 1987.

Table 4.9.1-2

SWP WATER DELIVERIES FOR AGRICULTURE, MUNICIPAL AND INDUSTRIAL USES,
RECREATION USE AT SWP FACILITIES AND HYDROELECTRIC ENERGY, 1962 to 1985.

| Year | Water Delivered (Acre-Feet) | | | | Recreation Supported (Recreation Days) b/ | Hydro-Electric Energy Generated (megawatt-hours) c/ | | | |
|----------|-----------------------------|------------------|------------|----------------------------|---|---|--|------------|------------|
| | Entitlement Water | | | Other Deliveries | | | | | |
| | Municipal & Industrial Use | Agricultural Use | Total | Municipal & Industrial Use | | | Agricultural Use Other Water a/ Total Delivery | | |
| 1962 | | | | | 18,289 | 18,289 | 30,000 | | |
| 1963 | | | | | 22,456 | 22,456 | 105,000 | | |
| 1964 | | | | | 32,507 | 32,507 | 331,600 | | |
| 1965 | | | | | 44,105 | 44,105 | 449,800 | | |
| 1966 | | | | | 67,928 | 67,928 | 482,700 | | |
| 1967 | 5,747 | 5,791 | 11,538 | | 53,605 | 65,143 | 455,200 | | |
| 1968 | 46,472 | 125,237 | 171,709 | 10,000 | 14,777 | 308,020 | 931,300 | | |
| 1969 | 34,434 | 158,586 | 193,020 | 0 | 72,397 | 284,246 | 1,554,800 | | |
| 1970 | 47,996 | 185,997 | 233,993 | 0 | 133,024 | 405,097 | 1,804,800 | | |
| 1971 | 85,286 | 272,054 | 357,340 | 2,400 | 293,619 | 697,486 | 2,085,900 | | |
| 1972 | 181,066 | 430,735 | 611,801 | 22,205 | 401,759 | 1,108,892 | 1,971,200 | | |
| 1973 | 293,824 | 400,564 | 694,388 | 3,161 | 293,255 | 1,034,470 | 2,502,000 | | |
| 1974 | 418,521 | 455,556 | 874,077 | 4,753 | 412,923 | 1,340,095 | 4,073,600 | | |
| 1975 | 641,621 | 582,369 | 1,223,990 | 21,043 | 601,859 | 1,914,062 | 4,189,300 | | |
| 1976 | 818,588 | 554,414 | 1,373,002 | 32,488 | 547,622 | 2,070,074 | 4,239,600 | | |
| 1977 | 280,919 | 293,236 | 574,155 | 0 | 390,176 | 964,331 | 3,951,900 | | |
| 1978 | 742,385 | 710,314 | 1,452,699 | 3,566 | 13,348 | 1,592,529 | 5,773,700 | | |
| 1979 | 690,659 | 969,237 | 1,659,896 | 66,081 | 582,308 | 2,497,681 | 5,298,700 | | |
| 1980 | 730,545 | 799,204 | 1,529,749 | 19,722 | 384,835 | 1,982,896 | 5,701,900 | | |
| 1981 | 1,057,273 | 852,289 | 1,909,562 | 12,000 | 896,428 | 3,101,839 | 6,017,800 | | |
| 1982 | 928,721 e/ | 821,303 | 1,750,024 | 0 | 215,873 | 2,121,717 | 6,187,700 | | |
| 1983 | 483,499 | 701,370 | 1,184,869 | 0 | 13,019 | 1,386,484 | 5,838,200 | | |
| 1984 | 723,468 f/ | 865,043 | 1,588,511 | 3,663 | 259,254 | 2,238,933 | 6,273,100 | | |
| 1985 | 998,138 | 1,002,915 | 2,001,053 | 9,638 | 292,372 | 2,717,629 | 6,639,800 | | |
| Total d/ | 9,209,162 | 10,186,214 | 19,395,376 | 210,720 | 5,525,429 | 2,885,384 | 28,016,909 | 76,889,600 | 54,187,000 |

a/ Includes preconsolidation repayment water, emergency relief water, exchange water, regulated delivery of local supply, non-SWP water delivered to Napa County FC&WCD through SWP facilities, conveyance of CVP water (including Decision 1485 water), recreation water, and demonstration ground water fill withdrawal.

b/ A recreation day is the visit of one person to a recreation area for any part of one day.

c/ Includes SWP share of generation from Hyatt-Thermalito, San Luis, Devil Canyon, Warne, and Castaic Powerplants.

d/ In addition, SWP dams have prevented millions of dollars worth of flood damage.

e/ Revised and corrected from, Bulletin 132-85 to reflect 557 acre-feet of 1978 exchange water (MWDC Basin) changed from other water to municipal and industrial use entitlement water.

f/ Revised and corrected from, Bulletin 132-85 to reflect 126 acre-feet of 1982 exchange water (MWDC Basin) changed from other water to municipal and industrial use entitlement water.

TABLE 4.9.1-3
 DELTA DRINKING WATER DIVERSIONS
 AND AREAS SERVED

| <u>Diversion Point</u> | <u>Area Served</u> |
|---------------------------------------|---|
| <u>State</u> | |
| North Bay Aqueduct (Cache Slough) | Solano-Napa County Fairfield Vacaville Vallejo Benicia Napa American Canyon |
| South Bay Aqueduct (Clifton Court) | Livermore Valley Alameda CWD Santa Clara Valley WD |
| California Aqueduct | Avenal Coalinga Kern County WA Antelope Valley MWDSC San Diego CWA Crestline-Lake Arrowhead San Bernardino Valley Palm Springs Indio |
| <u>Federal</u> | |
| Contra Costa Canal (Clifton Court) | Concord Oakley Pittsburg Antioch Martinez Pleasant Hill Walnut Creek |
| Delta-Mendota Canal (Old River) | Tracy Huron Dos Palos |

1/ SWC, 76, 6

The expected additional M&I demand for Bay-Delta water supply is a result both of the loss or degradation of alternative water supplies and of increases in population (SWC,4,6). Supreme Court decisions on the Colorado River have reduced MWD's supply of water by 692,000 AF/yr (SWC,3,2). Ground water pollution and overdraft have restricted the use of some ground water basins (SWC,3,9). Studies performed by DWR indicate a shortage of 1.4 MAF between existing dependable supplies and projected needs in southern California by 2010 (SWC,3,2; DWR,707,43) ⁽¹⁷⁾

Water
loss by
MWD



In the future the SWP and the CVP plan to expand deliveries to new areas and to areas experiencing increased need. SWP is studying a Coastal Branch which will supply water to Santa Barbara and San Luis Obispo counties, and an East Branch enlargement which will increase deliveries to the eastern part of the Metropolitan Water District's service area. CVP is studying an extended San Felipe Branch which will supply water to Monterey and Santa Cruz counties, as well as an American River Aqueduct which will increase deliveries to EBMUD's service area in the Bay Area. SWP is also planning transfer and storage facilities that will increase its water distribution capabilities at these locations: the Kern Water Bank, Los Banos Grandes Reservoir, the South Delta, and North Delta Facilities and additional pumps at the Delta Pumping Plant (DWR,707,42-53).

export
expansion
plans

1/ One of the assumptions of this study was that the maximum salinity level allowable at Clifton Court would be set at 100 ppm chlorides, a project goal. The SWRCB objective for export use at this location is 250 ppm chlorides. Using information from DWR studies, SWRCB staff estimated that the additional volume of water needed to meet the 100 ppm chloride level project goal at Clifton Court can be as much as 200,000 acre-feet per year.

WSD

4.9.2 Agriculture

The CVP and SWP export water from the Estuary to support many farming and ranching operations (RWQCB 5, 1975). The main area of agricultural use of export waters is the San Joaquin Valley; three of its counties, Fresno, Kern, and Tulare, ranked first, second, and third in the nation in gross cash receipts from annual farm marketing in 1982 (CVAWU, 41). The SWP exports water for agricultural use primarily in the Tulare Lake Basin, with smaller amounts exported to other areas. The CVP exports water for agricultural use as shown in Table 4.9.2-1.

TABLE 4.9.2-1
CVP EXPORT AREAS

| <u>Export Area</u> | <u>CVP Unit</u> |
|---------------------|---|
| San Joaquin Basin | Delta Mendota Canal San Luis Mendota Pool |
| Tulare Lake Basin | San Luis Cross Valley Canal |
| Contra Costa County | Contra Costa Canal |

The recently completed San Felipe Unit of the CVP will soon make deliveries to Santa Clara and San Benito counties.

By 1970 the entitlement of agricultural contracts (including exchange contractors^{1/}) to CVP export waters totaled over two million AF/yr (CVPWA, 10-1). With the addition of the Cross Valley Canal Unit and expansion of the San Luis Unit, the 1980 total was almost 2 1/2 million AF/yr (CVPWA, 10-1).

During the 1985 Water Year, the various units of the CVP exported a total of about 2,750,000 acre-feet of water to serve 1,220,000 acres (Table 4.9.2-2).

^{1/} Exchange contractors formerly diverted from the San Joaquin River, but exchanged their diversion rights for a contract that granted more consistent water supplies from the DMC. The maximum contractual entitlement of these users is 840,000 AF/yr (USBR, 1987).

TABLE 4.9.2-2
 AGRICULTURAL WATER EXPORTS AND SERVICE AREAS
 BY CVP UNIT FOR THE 1985 WATER YEAR

| CVP Unit | Water Exported (AF) | Area Served (ac) |
|--|---|--------------------------------------|
| Delta Mendota Canal (including exchange contractors) | 1,050,000 (CVPWA, 11; USBR, 1984; USBR, 1985) | 356,000 (T, XXVI, 186:6-8, 11-17) |
| San Luis | 1,545,000 (CVPWA, 11) | 698,000 (T, XXVI, 186a:24) |
| Mendota Pool | 94,000 (CVPWA, 11) | 42,000 (T, XXVI, 187:14) |
| Cross Valley Canal | 64,000 (CVPWA, 11(b)-3) | 125,000 (CVPWA, 11(b)-3) |
| Contra Costa Canal | 895 (T, XXVI, 185:16-21) | --- |
| TOTAL | 2,754,000 | 1,221,000 |

Although the recently completed San Felipe Unit began making deliveries in mid-1987, two contracts have been executed for a total of 68,600 AF/yr (T, XXVI, 194:2-8). The projected water use by the existing CVP contractors is not expected to differ substantially from this 1985 Water Year level (T, XXVI, 208:6-8). However, additional CVP supplies are needed to help solve ground water overdraft (T, XXVI, 209:6-13).

The SWP exports water for agricultural use via the California Aqueduct to Oak Flat WD in the San Joaquin Basin, to the Tulare Lake Basin and to southern California, and via the South Bay Aqueduct to Santa Clara and Alameda counties. The magnitude of SWP deliveries to the 13 southern California contractors for agricultural use was not identified in the hearing record. The annual SWP exports for agricultural use (excluding southern California) increased from about 237,000 AF in 1968 to about 1.3 million AF in 1985 (DWR, 461). The future need for exported SWP water for agriculture should not change substantially from this 1985 amount (DWR, 707, 11). However, Kern County needs an additional 300,000 AF/yr to help solve its ground water overdraft problem (SWC, 412, 5).

*SWP export
process*

The main change in agricultural production in the San Joaquin Valley since 1955 has been the increased acreage devoted to the production of vegetables, fruits and nuts (CVAWU, 26). The acreage of vegetables increased from about 250,000 acres in 1955 to almost 400,000 in 1985. The acreage devoted to the production of fruits and nuts increased from about 550,000 acres in 1955 to about 1,300,000 acres in 1985 (CVAWU, 26). The acreages of field crops and seeds in the San Joaquin Valley have remained relatively stable since 1955. Overall, the acreage devoted to these four major commodity groups (vegetables, fruits and nuts, field crops, and seeds) in the San Joaquin Valley has increased only about 25 percent from 1955 to 1985, from about 3.7 million acres to about 4.6 million acres (CVAWU, 26).

In 1985, the CVP units listed in Table 4.9.2-2 delivered over 2.7 million AF of water to over 1.2 million acres in the export areas of the San Joaquin Valley to produce crops with a gross value of about \$1.2 billion (CVPWA, 12; EDF, 11, G-148) (Table 4.9.2-3).

TABLE 4.9.2-3
MAJOR CROPS GROWN IN THE CVP EXPORT AREA
BY ACREAGE AND GROSS CASH VALUE

| Crop | Acreage ^{1/} (thousands of acres) | Gross Cash Value ^{1/} (millions of dollars) |
|--------------|---|---|
| Cotton | 450 | 360 |
| Alfalfa | 100 | 70 |
| Wheat | 90 | 22 |
| Tomatoes | 80 | 130 |
| Melons | 50 | 130 |
| Barley | 40 | 6 |
| Almonds | 30 | NA ^{2/} |
| Table Grapes | NA ^{2/} | 80 |
| Apricots | NA ^{2/} | 60 |
| Lettuce | NA ^{2/} | 60 |
| TOTAL | 1,221 | 1,200 |

1/ CVPWA, 12; EDF, 11, G-148

2/ Not available

In 1985, the SWP delivered over 1.3 million AF of water to about 445,000 acres in the export agricultural areas of the San Joaquin Valley to produce crops with a gross value of about \$431 million (DWR, 489h) (Table 4.9.2-4).

TABLE 4.9.2-4
MAJOR CROPS GROWN IN THE SWP EXPORT AREA
BY ACREAGE AND GROSS CASH VALUE

| Crop | Acreage ^{1/} (thousands of acres) | Gross Cash Value ^{1/} (millions of dollars) |
|--------------|---|---|
| Cotton | 210 | 154 |
| Alfalfa | 40 | 27 |
| Almonds | 35 | 26 |
| Wheat | 30 | 9 |
| Pistachios | 18 | 28 |
| Wine grapes | 18 | 13 |
| Table Grapes | 6 | 28 |
| Oranges | 4 | 19 |
| Carrots | 5 | 18 |
| Other | 79 | 109 |
| TOTAL | 445 | 431 |

1/ DWR, 489h

Since water usage and acreage for livestock, poultry, and dairy production were not identified in the hearing record by CVP or SWP export areas, an accurate account of the effect of export water on the market values of these products cannot be given. In addition, project export areas often use supplemental water supplies from ground water and local sources; only a part of the value of agricultural production in the export area can therefore be directly attributed to project exports. Only an indirect indication can be made from the fact that the market value of livestock, poultry and dairy products for the entire San Joaquin Valley in 1982 was over half the value of all crops (CVAWU,28):

| | | | |
|------------------------------|---------------|-----------------------|-------------------------|
| Crops | \$455 million | 1969 \$933 million | 1982 \$4,039 million |
| Livestock, Poultry, Dairy | \$199 million | \$751 million | \$2,053 million |

The hearing record does not indicate any present or anticipated future problem of adequate water quality for agricultural production in the export areas. However, three main problems have affected and will continue to affect the agricultural uses in the export areas: (1) drainage; (2) ground water overdraft; and (3) urbanization. The drainage problems on the west side of the San Joaquin Valley have been well documented. The water quality problems associated with drainage disposal threatens agricultural production in many parts of the export areas, e.g., Westlands WD and entities draining to Grassland WD (EDF, 11, I-2 and I-3). The amount of land with drainage problems will increase in the export area. The use of evaporation ponds for drainage disposal removes agricultural lands from production, especially in the Tulare Lake Basin; ground water overdraft causes lowered water tables and land subsidence and in turn causes higher pumping costs or increased demand for export water; subsidence creates problems of soil compaction and unlevel fields. The overdraft problem is particularly widespread in the Tulare Lake Basin. Encroaching urbanization continues to remove agricultural land from production in the export area.

4.9.3 Fishery Habitat

Export fishery habitat consists primarily of the reservoirs and conveyance channels used for movement and storage of Bay-Delta water south of the Delta. In all cases this habitat may be classified as warm water fishery habitat. The major facilities discussed here and in Section 4.9.5 (Export Recreation) are:

- San Joaquin Valley and San Francisco Bay Area

Delta-Mendota Canal, San Luis Canal, Edmund G. Brown California Aqueduct, Lake Del Valle, Bethany Reservoir, San Luis Reservoir (and O'Neill Forebay), and Los Banos Reservoir.

FIGURE 4.9.3-1 State Water Project Recreation Developments
 (from: SWC, 65, 6)

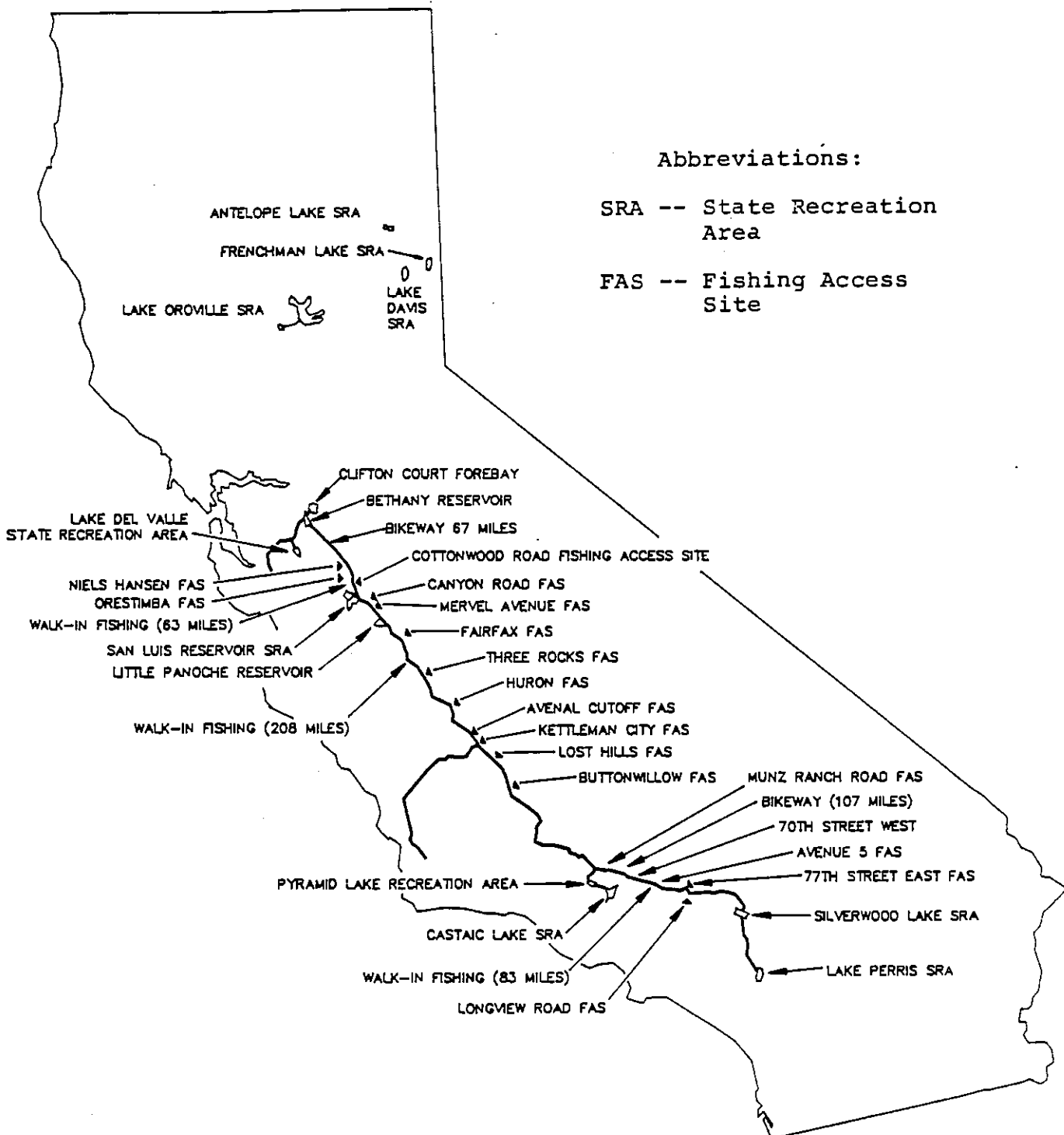

Abbreviations:

- SRA -- State Recreation Area
- FAS -- Fishing Access Site

SOURCE: DWR BULLETIN 132-86

o Southern California

West Branch California Aqueduct, East Branch California Aqueduct, Pyramid Lake, Castaic Lake, Silverwood Lake, and Lake Perris (SWC,65,6).

Recreational access at all SWP facilities is shown in Figure 4.9.3-1 (SWC,65,6). Expansion of this habitat will not occur unless additional facilities are built (e.g., Los Banos Grandes Reservoir) (DWR,707).

Some of the eggs and larvae of some fish entrained into the export pumps survive and develop in the aqueducts and some of the reservoirs such as Bethany Reservoir and San Luis Reservoir (and O'Neill Forebay) (SWC,65,45). The hearing record is unclear whether these populations are self-sustaining or are maintained by additional entrainment. In other reservoirs, the majority of fish are planted for recreational fishing (SWC,65,47) (see Section 4.9.5). (It was inferred from SWC,65,47 that DFG plants the fish in these reservoirs, but no direct evidence was presented.) No information was presented on which species are planted, or what percent of total statewide fish planting is dedicated to SWP facilities.

The aqueducts tend to provide a relatively stable habitat for fish because the export water quality is maintained for municipal and industrial standards, and because water depth in the aqueducts does not change. In some reservoirs such as San Luis, however, the habitat may change significantly due to either seasonal variation in temperature or drawdown to meet water demands. The San Luis Reservoir recreational storage objective for Labor Day is 6,900 acres of surface area, or approximately half the surface area of the full reservoir (DWR,708,14). However, this converts to an 83 percent reduction in storage and, therefore, in fishery habitat. Other reservoirs, especially the terminal SWP reservoirs in southern California, are operated to retain more stable water levels because of the level of recreational activity on them (T,39,122:2-9); DWR presented the specific operating criteria (DWR,708.)

4.9.4 Export Wildlife Use

Water exported from the Sacramento-San Joaquin watershed provides some wetland, aquatic, and riparian habitat wherever it is delivered. Examples of important wildlife uses may be found in a number of export areas (SWRCB,14,III-9). Water in SWP reservoirs and in wildlife areas in southern California provides aquatic habitat where there might formerly have been none or replaces wetland habitat which was damaged or destroyed by earlier urbanization or water development. Substantial waterfowl habitat for example is maintained with DMC water in the Grassland Water District, an area that formerly received water from San Joaquin River overflows and agricultural return flows which ceased when Friant Dam began operations (EDF,11,II-3). The quality of exported water generally meets the water quality needs of wildlife in the export areas, although supplies are unreliable (DFG,2,A-8). Attempts to develop more wildlife habitat by using agricultural drainage water have led to toxicity problems (EDF,11,II-11).

4.9.5 Export Recreation

The aqueducts and reservoirs in the SWP^{1/} are used for recreation in both central and southern California. Fishing and bicycle riding are the main activities along the aqueducts, and numerous fishing access points are available along them (SWC,65,6)(see Figure 4.9.3-1). The reservoirs are used for a wide variety of water-contact and non-water-contact activities, including fishing, swimming, boating, waterskiing, camping, picnicking and bird watching (SWC,65,5). About five million visitors used the SWP facilities south of the Delta in 1985 and they spent an estimated \$95 million to travel to and use these sites (SWC,65,7,14). More than one million game fish were stocked in 1985 (SWC,65,7) to support recreational fishing activity in the four southern California SWP reservoirs. No evidence was presented on alternative sites for freshwater recreation in southern California.

The water quality requirements for salinity and other constituents of SWP and CVP water to protect municipal and industrial uses also protect recreational uses. The aqueducts are usually full, and the southern California reservoirs are operated to minimize impacts on recreation during the peak recreation seasons (T,XXXIX, 122:2-9) primarily by limiting drawdown rates (DWR,708,15-18).

^{1/} Discussion is limited to recreational activities directly related to export facilities of the SWP. No information was provided on recreation at CVP export facilities other than those used jointly by the CVP and SWP, which are included in the SWP descriptions. These facilities are listed in Section 4.9.3 (Export Fishery Habitat).

References for Chapter 4

- Regional Water Quality Control Board #5, Water Quality Control Plan Report 5B, Volume I, 1975, pg. I-2-2.
- Department of Water Resources Bulletin 166-3 "Urban Water Use in California", October 1983, pgs. 1-25.
- Department of Water Resources, Bulletin 27 "Variation and Control of Salinity in the Sacramento-San Joaquin Delta and Upper San Francisco Bay", 1931, pgs. 21 and 47.
- State Water Resources Control Board, "Environmental Impact Report for the Water Quality Control Plan and Water Right Decision, Sacramento-San Joaquin Delta and Suisun Marsh", August 1978, pgs. 142,143.
- National Oceanic and Atmospheric Administration. 1986. Marine Environmental Assessment, San Francisco Bay, 1985 Annual Summary, 122 pp.
- Department of Water Resources. 1987. Sacramento-San Joaquin Delta Atlas.]
- California Department of Fish and Game, and U.S. Fish and Wildlife Service. 1980. Sacramento-San Joaquin Delta Wildlife Habitat Protection & Restoration Plan.
- Department of Water Resources. 1982. Draft Environmental Impact Report. Proposed Additional Pumping Units. Harvey O. Banks Delta Pumping Plant.
- Regional Water Quality Control Board #4, Water Quality Plan Report 4B, Volume I, 1975, pg I-2-2.
- USBR, Factsheet: "Exhibits and Testimony before SWRCB, Bay-Delta Hearing, 1987", 1987.
- Department of Finance, Report 86-E-2, January 1987.
- RWQCB 5. 1975. Water Quality Control Plan Report, Sacramento River Basin (5A); Sacramento-San Joaquin Delta Basin (5B), San Joaquin Basin (5C). Volume I.
- USBR. 1952. Report of Operations. Table 14. December, 1952.
- USBR. 1984. Report of Operations. Table 28. December, 1984.
- USBR. 1985. Report of Operations. Table 28. December, 1985.
- USBR. 1987. Fact Sheet, USBR Exhibits and Testimony before SWRCB, Bay-Delta Hearings.

CVAW-5
CVFJA?

5.0 OPTIMAL LEVELS OF PROTECTION FOR BENEFICIAL USES OF BAY-DELTA ESTUARY WATER

5.1 INTRODUCTION

The levels of flow and salinity considered to be optimal for the protection of beneficial uses are presented in this chapter. The levels needed for protection are developed solely for the beneficial use being addressed; other beneficial uses are not considered. Three levels are addressed: (1) the no action alternative; (2) The advocated level(s); and (3) the optimal level of protection.

1. The no action alternative is considered to provide the minimum level of flow and salinity protection for the beneficial use being discussed. It is the level of protection currently existing at any particular site as a result of the Delta Plan, and the level considered to be in compliance with federal regulations protecting existing uses (40 CFR Section 131.3(e) and (f))^{1/}. Those standards affecting South Delta Water Agency (SDWA) were held in abeyance, at their request, awaiting the results of negotiation among them, Department of Water Resources (DWR) and U.S. Bureau of Reclamation (USBR). Therefore, the existing 500 mg/l TDS standards for Vernalis contained in the New Melones water right permit is considered the "no action" value for this chapter. This standard would be in effect for this area if no further action occurred. Though water quality standards for San Francisco Bay were not explicitly addressed in the Delta Plan, the effects on the Bay were indirectly determined from Delta inflows regulated by the Delta Plan.
2. Advocated level(s) of protection are those recommended by witnesses during Phase I of the hearing. Testimony or exhibits that recommended flow and/or salinity levels to protect a specific beneficial use are summarized. (They are not given in any priority or ranking.)
3. The optimal level of protection can be considered the maximum level of protection possible for a beneficial use. This protection level is identified for a particular site when appropriate, and when data are available. The level can be the same as the two previous levels, if either provides optimal protection; or it can be a separate level based upon an independent evaluation of available data. The optimal level of protection will be used as a point of comparison for developing globally balanced objectives in chapter 6 and 7.

^{1/} The level of protection necessary to maintain the beneficial uses actually attained on or after November 28, 1975 level of protection. The level is mandated to the State Board by EPA regulations (40 CFR 131.12) and is considered to be the minimum protection which may be afforded a beneficial use.

5.2 Hydrologic Considerations

Flow and salinity at any particular location in the Delta is dependent upon Delta inflows, agricultural drainage return flows, consumptive uses, exports, and the placement of the Delta Cross-Channel gates. The major factors affecting the overall Delta flow and salinity are the magnitude and relative distribution of the Sacramento and San Joaquin river's inflows, since they are the major sources of water for the Delta. In the southern Delta, the flow and salinity is almost exclusively influenced by inflow and salt loading from the San Joaquin River due to its proximity to Vernalis. The internal Delta, on the other hand, is influenced to some degree by both river systems, especially when Delta exports are high. For the purpose of considering river effects on the beneficial uses discussed in this chapter, all of the Estuary locations were considered to be part of the hydrologic classification of the Sacramento River system except the following locations which were considered to receive water from the San Joaquin River system: San Joaquin River at Vernalis; San Joaquin River at Mossdale; San Joaquin River at the former location of Brandt Bridge; the bifurcation of Old and Middle River; Middle River at Howard Road Bridge; and Old River at Tracy Road Bridge.

5.3 DETERMINING THE OPTIMAL LEVEL OF PROTECTION FOR BENEFICIAL USES

5.3.1 Municipal and Industrial

5.3.1.1 No Action Alternative

Municipal and Industrial (M&I) use is currently protected by standards developed in the Delta Plan. These standards, listed in Table 5.3.1.1-1, cover both M&I categories of beneficial uses. The level of protection considered adequate to protect municipal uses was determined by the Delta Plan to be 250 mg/L chlorides. This level was not based on a primary health requirement, but on a secondary aesthetic requirement, set by the Department of Health Services (DHS).

The level set for the protection of industrial uses was determined to be 150 mg/L chlorides. This standard, intended to protect the historical water supply of two paper manufacturing industries provided a salinity necessary to maintain industry products.

5.3.1.2 Advocated Levels of Protection

The participating organizations making M&I recommendations have recommended that the Delta Plan be retained in total or in part to protect M&I use (DWR, 280; T, LIX, 189:1-7; T, VI, 125:4-15). Modifications to the Delta Plan M&I standards were recommended by DWR, USBR, SWC, and CCWD. DWR and USBR are unified in their recommended modifications. SWC's recommended modifications fall within the recommendations made by DWR and USBR. The participants' recommendations are:

Table 5.3.1.1-1--Decision 1485
 Water Quality Standards
 For the Sacramento-San Joaquin Delta and Suisun Marsh^{1/}

| Beneficial Use Protected and Location | Parameter | Description | Year Type ^{2/} | Values |
|---|-----------|--|-------------------------|--|
| MUNICIPAL AND INDUSTRIAL | | | | |
| Contra Costa Canal Intake at Pumping Plant No.1 | Chloride | Maximum Mean Daily Cl ⁻ in mg/l | All | 250 |
| Contra Costa Canal Intake at Pumping Plant No. 1 or | Chloride | Maximum Mean Daily 150 mg/l Chloride for at least the number of days shown during the Calendar Year. Must be provided in intervals of not less than two weeks duration. (% of year shown in parenthesis) | | Number of Days Each Calendar Year Less than <u>150 mg/l Chloride</u> |
| Antioch Water Works Intake on San Joaquin River | | | Wet | 240 (66%) |
| | | | Ab. Normal | 190 (52%) |
| | | | Bl. Normal | 175 (48%) |
| | | | Dry | 165 (45%) |
| | | | Critical | <u>155 (42%)</u> |
| City of Vallejo Intake at Cache Slough | Chloride | Maximum Mean Daily Cl ⁻ in mg/l | All | 250 |
| Clifton Court Forebay Intake | Chloride | Maximum Mean Daily Cl ⁻ in mg/l | All | 250 |
| Delta Mendota Canal | Chloride | Maximum Mean Daily Cl ⁻ in mg/l | All | 250 |

1/ All values for surface zone measurements. All mean daily values are based on at least hourly measurements. All dates are inclusive.

2/ The year for the preceding Water Year will remain in effect until the initial forecast of unimpaired runoff for the current Water Year is available.

- DWR, USBR, and SWC (where noted by reference)
 - Eliminate the 250 mg/l maximum mean daily chloride quality standard at Cache Slough. The City of Vallejo will divert water from the newly finished North Bay Aqueduct; the Cache Slough diversion point will only be used as a secondary M&I supply source (DWR,280).
 - Add a quality objective at the North Bay Aqueduct intake at Barker Slough. The recommended objective would be set at a maximum mean daily chloride level of 250 mg/l for all water year types. Barker Slough is an M&I diversion point for Napa, Vallejo, and Sonoma counties (DWR,280).
 - Eliminate the 150 mg/l chloride quality standard at both the Antioch Water Works Intake on the San Joaquin River and the Contra Costa Canal Intake at Rock Slough. This standard is set to protect industrial uses in the Antioch-Pittsburg area. The recommendation to eliminate this standard is based on the evidence indicating that diversion of water for industry of this quality at Antioch is not reasonable when considering the Delta outflow required to maintain it (DWR,280;T,LIX,149:12-20).
 - Add a quality objective at Old River near Rock Slough. The recommended objective would be set at a maximum mean daily chloride level of 250 mg/l for all water year types. This recommendation is based on the conclusion that an objective at Old River near Rock Slough will help in determining an "allocation of responsibility" for meeting the standard at the Contra Costa Canal Intake (DWR,280;T,VI,97:8-19;T,LIX,213:8-214,8).
- CCWD
 - Add a quality objective at the site of the future intake to the Kellogg/Los Vaqueros Reservoir. The location of the intake has not yet been determined. The recommended objective would be set at a maximum chloride level of 50 mg/l for the months of April through June (T,VII,57:13-19; T,VII,118:16-120,9).

5.3.1.3 Optimal Level of Protection

Retain the Delta Plan standards to protect M&I beneficial uses with the following changes:

- Retain the 250 mg/l maximum mean daily standard at Cache Slough as discussed in 5.3.1.2, under the condition that it would only be in effect when water is being diverted from there for M&I uses.
- Add a 250 mg/l maximum mean daily chloride objective at Barker Slough as discussed in 5.3.1.2. This objective will provide protection for M&I uses at this new point of diversion.

- Add a 250 mg/l maximum mean daily chloride objective, to become effective when the proposed facility begins operation, at the future intake to the proposed Kellogg/Los Vaqueros Reservoir. The objective will provide reasonable protection to the M&I uses supplied by the proposed facility.
- Retain the 150 mg/l maximum mean daily chloride objective at the Contra Costa Canal intake/Antioch water works intake. Extend the period of time that this objective is met to the full year. Industrial water quality within the Delta is protected in the Delta Plan by this standard. The amount of time this standard is in effect varies according to year type. Optimally, this objective would be met for the full year and is proposed as such under the optimal levels of protection.

The advocated addition of a 250 mg/l chloride objective at Old River near Rock Slough has been determined to be inappropriate. The current standard at the Contra Costa Canal Intake provides full protection for M&I diversions at that location. The advocated objective, located a distance away from the current point of diversion; does not represent the salinity at the point of diversion; it therefore does not protect the M&I beneficial uses served by the Contra Costa Canal as well as they are by the current standard. Also, the basis for the recommendation, i.e., that it would allow a "...later allocation of responsibilities..." for meeting the standard at the Contra Costa Canal does not justify the addition of a new standard.

The CCWD's proposal to add a 50 mg/l chloride objective at the intake of the proposed Kellogg/Los Vaqueros Reservoir should be rejected because the hearing evidence and testimony presented on M&I beneficial use needs do not justify it. The water quality standard for MUN use is 250 mg/l chlorides, which is a taste rather than a health consideration. Industries outside of the Delta, many of which are supplied from a diversion point other than the Contra Costa Canal, have not submitted evidence showing a need for water quality better than 250 mg/l chlorides. Based on this information, a level of protection better than 250 mg/l is not justified.

Table 5.3.1.3-1 is a list of averaged monthly salinities for each water year type. The source data are mean monthly hourly salinities over a tidal cycle simulated for an unimpaired condition over the Water Years 1922 through 1978. The data show that at no time do these average values exceed the 250 ppm chloride standard set forth in the Delta Plan. Table 5.3.1.3-2 lists the locations and optimal levels protection for M&I uses.

TABLE 5.3.1.3-1
UNIMPAIRED FLOW MEAN SALINITY
(mg/l chlorides)

| WATER YEAR INDEX | JAN | FEB | MAR | APR | MAY | JUN | JUL | AUG | SEP | OCT | NOV | DEC |
|--------------------------------|-----|-----|-----|-----|-----|-----|-----|-----|-----|-----|-----|-----|
| CLIFTON COURT | | | | | | | | | | | | |
| CRITICAL | 190 | 154 | 119 | 77 | 64 | 102 | 137 | 154 | 146 | 176 | 199 | 196 |
| DRY | 145 | 105 | 80 | 56 | 40 | 52 | 107 | 144 | 160 | 163 | 195 | 182 |
| B. NORMAL | 114 | 85 | 63 | 45 | 29 | 44 | 91 | 130 | 158 | 189 | 162 | 127 |
| A. NORMAL | 100 | 53 | 45 | 32 | 21 | 34 | 74 | 114 | 139 | 182 | 200 | 167 |
| WET | 74 | 63 | 52 | 36 | 21 | 22 | 50 | 99 | 140 | 193 | 176 | 99 |
| TRACY PUMPING PLANT | | | | | | | | | | | | |
| CRITICAL | 190 | 182 | 160 | 136 | 109 | 93 | 99 | 127 | 152 | 138 | 162 | 183 |
| DRY | 151 | 143 | 129 | 108 | 88 | 72 | 73 | 100 | 131 | 135 | 156 | 158 |
| B. NORMAL | 161 | 142 | 123 | 101 | 80 | 65 | 62 | 81 | 113 | 133 | 164 | 171 |
| A. NORMAL | 148 | 116 | 91 | 75 | 60 | 50 | 48 | 62 | 96 | 144 | 166 | 166 |
| WET | 124 | 93 | 72 | 58 | 47 | 39 | 37 | 47 | 75 | 142 | 169 | 166 |
| CONTRA COSTA CANAL | | | | | | | | | | | | |
| CRITICAL | 142 | 146 | 157 | 132 | 84 | 74 | 100 | 101 | 146 | 119 | 137 | 145 |
| DRY | 131 | 137 | 130 | 93 | 56 | 50 | 66 | 90 | 92 | 135 | 139 | 133 |
| B. NORMAL | 60 | 59 | 57 | 48 | 33 | 30 | 39 | 54 | 55 | 56 | 58 | 59 |
| A. NORMAL | 69 | 68 | 66 | 49 | 29 | 26 | 36 | 52 | 54 | 71 | 71 | 71 |
| WET | 107 | 103 | 100 | 86 | 44 | 26 | 41 | 65 | 95 | 104 | 109 | 108 |
| CACHE SLOUGH | | | | | | | | | | | | |
| CRITICAL | 16 | 16 | 16 | 16 | 17 | 18 | 20 | 21 | 22 | 19 | 18 | 17 |
| DRY | 16 | 16 | 16 | 16 | 16 | 17 | 18 | 19 | 19 | 20 | 19 | 16 |
| B. NORMAL | 18 | 18 | 18 | 18 | 18 | 18 | 20 | 21 | 22 | 21 | 19 | 18 |
| A. NORMAL | 18 | 18 | 18 | 18 | 18 | 18 | 19 | 21 | 22 | 22 | 20 | 19 |
| WET | 19 | 19 | 19 | 19 | 20 | 20 | 20 | 22 | 22 | 23 | 21 | 20 |
| LINDSEY SLOUGH (BARKER SLOUGH) | | | | | | | | | | | | |
| CRITICAL | 16 | 16 | 16 | 16 | 16 | 17 | 17 | 19 | 23 | 17 | 16 | 16 |
| DRY | 16 | 16 | 16 | 16 | 16 | 16 | 17 | 17 | 17 | 18 | 17 | 16 |
| B. NORMAL | 18 | 18 | 18 | 18 | 18 | 18 | 19 | 19 | 19 | 19 | 18 | 18 |
| A. NORMAL | 18 | 18 | 18 | 18 | 18 | 18 | 19 | 19 | 19 | 19 | 19 | 18 |
| WET | 20 | 20 | 20 | 20 | 20 | 20 | 20 | 20 | 20 | 21 | 20 | 20 |

TABLE 5.3.1.3-2
OPTIMAL LEVEL OF PROTECTION FOR
MUNICIPAL AND INDUSTRIAL USES

| Beneficial Use Protected and Location | Parameter | Description | Year Type | Values |
|--|-----------|---|-----------|--------|
| MUNICIPAL | | | | |
| Contra Costa Canal Intake ^{1/} at Pumping Plant #1 | Chloride | Maximum Mean Daily Chloride in mg/l | All | 250 |
| Clifton Court Forebay Intake at West Canal | Chloride | Maximum Mean Daily Chloride in mg/l | All | 250 |
| Delta Mendota Canal at Tracy Pumping Plant | Chloride | Maximum Mean Daily Chloride in mg/l | All | 250 |
| North Bay Aqueduct at Barker Slough | Chloride | Maximum Mean Daily Chloride in mg/l | All | 250 |
| City of Vallejo Intake ^{2/} at Cache Slough | Chloride | Maximum Mean Daily Chloride in mg/l | All | 250 |
| INDUSTRIAL | | | | |
| Contra Costa Canal Intake at Pumping Plant #1 | Chloride | Maximum Mean Daily Chloride in mg/l | All | 150 |
| or | | | | |
| Antioch Water Works Intake on San Joaquin River | | | | |

1/ This objective will remain in effect until Contra Costa Water District moves its intake to Clifton Court Forebay.

2/ Only used as a control station if City of Vallejo is taking water from this source.

5.3.2 (not used)

5.3.3 Agriculture

5.3.3.1 No Action Alternative

- Western Delta

In the Delta Plan, the 0.45 millimhos/centimeter (mmhos/cm) electrical conductivity (EC) agricultural standards set for applied water in the western Delta were based upon the corn criterion which provided 100 percent corn yield in this region's subirrigated organic soil. These standards were relaxed in all water year types except wet years at Emmaton and Jersey Point, and in the above normal year at Jersey Point. The amount of relaxation was based on time weighted average of water quality over the period April 1 to August 15 for conditions that would exist without Central Valley Project (CVP) and the State Water Project (SWP) conditions (Without Project conditions). Adjustment of the standards for water year type was justified based on the water quality that would have occurred in the absence of the projects for such deliveries. Table 5.3.3.1-1 lists the numerical standards set for western Delta agriculture.

TABLE 5.3.3.1-1
WATER QUALITY STANDARDS FOR WESTERN DELTA AGRICULTURE^{1/}

| <u>Location</u> | <u>Parameter</u> | <u>Description</u> | <u>Year Type</u> ^{2/} | <u>Values</u> | |
|---------------------------------------|------------------|---|--------------------------------|--------------------------------------|---|
| | | | | <u>0.45 EC April 1 to Date Shown</u> | <u>EC from Date Shown^{3/} to August 15</u> |
| Emmaton on the Sacramento River | EC | Max. 14-day Running Avg. of Mean Daily EC in mmhos/cm | Wet | August 15 | — |
| | | | Ab. Norm | July 1 | 0.63 |
| | | | Bl. Norm | June 20 | 1.14 |
| | | | Dry | June 15 | 1.67 |
| | | | Critical | -- | 2.78 |
| Jersey Point on the San Joaquin River | EC | Max. 14-day Running Avg. of Mean Daily EC in mmhos/cm | Wet | August 15 | — |
| | | | Ab. Norm | August 15 | -- |
| | | | Bl. Norm | June 20 | 0.74 |
| | | | Dry | June 15 | 1.35 |
| | | | Critical | -- | 2.20 |

1/ Water Quality Control Plan, August 1978

2/ The year type for the preceding water year will remain in effect until the initial forecast of unimpaired runoff for the current water year is available.

3/ When no data are shown EC limit continues from April 1.

- Interior Delta

The Delta Plan agricultural water quality standards for the interior Delta were set using the same corn criterion as in the western Delta. However, under Without Project conditions, water quality in the interior Delta during the irrigation season was better than in the western Delta. Therefore, water year type relaxations for the interior Delta were not as severe. Table 5.3.3.1-2 lists the interior Delta water quality standards set in the Delta Planhearing process.

TABLE 5.3.3.1-2
WATER QUALITY STANDARDS FOR INTERIOR DELTA AGRICULTURE^{1/}

| <u>Location</u> | <u>Parameter</u> | <u>Description</u> | <u>Year Type</u> ^{2/} | <u>Values</u> | |
|---|------------------|--|--------------------------------|--|--|
| | | | | <u>0.45 EC April 1 to Date Shown</u> | <u>EC from Shown^{3/} to August 15</u> |
| Terminous on the Mokelumne River | EC | Max. 14-day Running Avg. of Mean Daily EC in mmhos/cm | Wet | August 15 | -- |
| | | | Ab. Norm | August 15 | -- |
| | | | Bl. Norm | August 15 | -- |
| | | | Dry | August 15 | -- |
| | | | Critical | -- | 0.54 |
| San Andreas Landing on the San Joaquin River | EC | Max. 14-day Running Avg. of Mean Daily EC in mmhos/cm | Wet | August 15 | -- |
| | | | Ab. Norm | August 15 | -- |
| | | | Bl. Norm | August 15 | -- |
| | | | Dry | June 25 | 0.58 |
| | | | Critical | -- | 0.87 |

1/ Water Quality Control Plan, August 1978.

2/ The year type for the preceding water year will remain in effect until the initial forecast of unimpaired runoff for the current water year is available.

3/ When no data are shown EC limit continues from April 1.

- Southern Delta

Water quality standards for the southern Delta in the Delta Plan were based on University of California guidelines for the quality requirements of two of the most predominant salt sensitive crops grown in the southern Delta, beans and alfalfa. They recommended an applied water quality for beans of 0.7 mmhos/cm EC from April through August, and 1.0 mmhos/cm EC for alfalfa the remainder of the year (WQCP, 8/79; VI-18, 19).

The standards were not implemented pending completion of New Melones Reservoir and an agreement among the South Delta Water Agency, the Department of Water Resources, and the Bureau of Reclamation to complete suitable circulation and water supply facilities. Upon completion of New Melones Reservoir in 1981, a 500 mg/l total dissolved solids (TDS) (770 mmhos/cm EC) standard at Vernalis came into effect. In the Delta Plan the Board stated that, if by January 1, 1980 facilities and water supplies were not in place, the Board would take appropriate enforcement action to prevent encroachment on riparian rights in the southern Delta. At South Delta Water Agency's request, this enforcement action was postponed awaiting results of continuing negotiations among the three agencies. For the purposes of the no action alternative these standards will be considered to have been in place. Table 5.3.3.1-3 lists the southern Delta water quality standards used as the no-action alternative objectives.

TABLE 5.3.3.1-3
WATER QUALITY STANDARDS FOR SOUTHERN DELTA AGRICULTURE^{1/}

| <u>Location</u> | <u>Parameter</u> | <u>Description</u> | <u>Year</u> <u>Type</u> | <u>Values</u> | |
|---|------------------|--|----------------------------|-------------------------|----------------------------|
| Vernalis near the San Joaquin River | TDS | Max. 30-day Running Avg. of Mean Daily TDS in mg/l | All ^{2/} | | 500 |
| | | | | April 1 to August 31 | September 1 to March 31 |
| Tracy Road Bridge on Old River | EC | Max. 30-day Running Avg. of Mean Daily EC in mmhos/cm | All ^{3/} | 0.7 | 1.0 |
| Old River near Middle River | | | | | |
| Brandt Bridge on San Joaquin River | | | | | |
| Vernalis near the San Joaquin River | | | | | |

1/ Water Quality Control Plan, August 1978

2/ After New Melones Reservoir becomes operational and until the standards below become effective.

3/ To become effective only upon the completion of suitable circulation and water supply facilities.

5.3.3.2 Advocated Levels of Protection

Central Delta Water Agency (CDWA):

- Water Quality Objectives

The agricultural water quality objectives for the Delta should be set at a minimum water quality of 0.45 mmhos/cm EC year round except for adjustments in the drier months of drier years. The objective should not require a "leaching regimen" more rigorous than "winter flooding" or "fall sub-irrigation" more frequently than once in three years (CDWA, Brief, 26-27). Delta leaching practices were defined in Section 4.4.1 of this Plan.

- Monitoring Locations

The CDWA requests that monitoring stations be established at Old River near Holland Tract or Rancho Del Rio and on Turner Cut near McDonald Island Bridge, in addition to those previously established by the Delta Plan at Emmaton, Jersey Point, San Andreas Landing and Terminous (CDWA, Brief, 27).

- Water Level Objectives

CDWA stated that, "Water level objectives need to be established to prevent the operations of export diversions from depleting local channel volumes beyond the point that agricultural pumps and siphons are not adequately supplied" (CDWA, Brief, 27-28). No specific method of implementing this was recommended.

Central Valley Project Water Users Association (CVPWA):

- Water Quality Objectives

Objectives should be established at 1.5 mmhoS/cm EC for the April 1 through August 15 period at Emmaton and Jersey Point. This objective should be adjusted to 3.0 mmhos/cm EC in critical Water Years (CVPWA, Brief, 49). No objectives need be established for the areas of the Delta covered by contracts with the Department of Water Resources. DWR currently meets the Delta Plan standards in contracts with ECCID and NDWA (CVPWA, Brief, 49).

- South Delta

Meeting the existing 500 mg/l TDS standard at Vernalis must be the responsibility of all water right holders on the San Joaquin system (CVPWA, Brief, 49).

Contra Costa County Water Agency (CCCWA):

- Water Quality Objectives

The CCCWA recommends that the minimum water quality standard necessary to achieve a 100 percent yield of corn be set at 0.45 mmhos/cm EC for organic soils in the Delta (CCCWA, Brief, 17).

Delta Tributaries Agency Committee (DTAC):

- Water Quality Objectives

DTAC recommends relaxation of the Delta Plan agricultural standard in the Central Delta, to the range of 1.5 to 2.5 deciSiemens/meter in all but critical years (One deciSiemen/meter is approximately equal to one mmho/cm EC). No objectives were suggested for critical years (DTAC, Brief, 6).

- Leaching Objectives

Water quality standards should be carefully established "to provide fall leaching water at the levels needed to leach a necessary minimum amount of salt from the crop root zone of Delta soils, but such leaching standard should be related to the quantity of water available for such leaching" (DTAC, BNF, 6-7).

- Southern Delta Objectives:

DTAC recommends that the Board impose a short timetable for completion of the negotiations between SDWA, DWR, and USBR. Pending completion of such an agreement, the Board should require elimination of reverse flows in the San Joaquin River which are attributable to export pumping, and continuance of Delta plan standards (DTAC, Brief, 6-7).

Department of Water Resources (DWR):

- Water Quality Objectives

"Water quality objectives for the western and central Delta should be based upon the results and information derived from the Corn Study" (DWR, Brief, 28). No specific numerical water quality criteria were recommended.

- Leaching Objectives

An objective for post-harvest subirrigation leaching should be provided for a ten-day period between November 1 and December 20 at the Emmaton and Jersey Point stations. This objective should be in effect only when the upstream October 1 storage conditions are at or above the normal operating level which DWR defines as 11 million acre-feet for the following major Sacramento River system reservoirs: Shasta,

Whiskey Town, Black Butte, Frenchman, Antelope, Grizzley Valley, Oroville, Almanor, New Bullards Bar, Engelbright, Folsom, Berryessa, and Trinity. Furthermore, a winter ponding objective should be provided at the Junction Point and San Andreas Landing stations for the months December through February (DWR, Brief, 29-30).

- Monitoring Locations

DWR recommends that specific Delta agricultural objectives for the irrigation season should be adopted for the following locations: (1) Sacramento River at Emmaton; (2) San Joaquin River at Jersey Point; (3) Mokelumne River at Terminous; (4) San Joaquin River at San Andreas Landing; and (5) Cache Slough near Junction Point (DWR, Brief, 30-31). Furthermore, the water quality objective at Emmaton should be eliminated when overland water supply facilities are developed for Sherman Island (DWR, Brief, 32). The objective would be moved to the intake of the overland facilities.

- Southern Delta Objectives

Negotiations should be completed among the DWR, USBR, SDWA to provide permanent solutions to the problems of local water level, water quality and circulation in the southern Delta (DWR, Brief, 32).

North Delta Water Agency (NDWA) and East Contra Costa Irrigation District (ECCID):

- Water Quality Objectives

NDWA and ECCID recommend that no change be made in Delta agricultural water objectives which would impair the contractual rights and obligations embodied in the contracts among NDWA, ECCID, and DWR (NDWA, Brief, 2). These standards are outlined in summaries of testimony for ECCID and NDWA.

South Delta Water Agency (SDWA):

- Water Flow and Quality Objectives (Without Facilities)

SDWA advocated two sets of recommendations. The first are recommendations with no south Delta facilities (SDWA, 115, 1-2). The second are recommendations with south Delta facilities (SDWA, 116, 1-2). SDWA recommends that water quality at any monitoring points should not exceed an average of 400 mg/l TDS for the period March 1 through September 30 and must not exceed 400 mg/l TDS on a seven-day running average during March through June 30 and 500 mg/l TDS seven-day running average between July 1 and October 31. A TDS of 550 mg/l would be the maximum permissible seven-day running average between November 1 and February 28 (T, XV, 31: 15-31: 23).

The minimum flow at Vernalis should comply with the following schedule to maintain the above water quality (the following figures relate to SDWA channel depletion, with a 500 cfs 5-day running average minimum flow. They do not include a flushing flow.):

| | |
|-----------|---------|
| October | 696 cfs |
| November | 583 |
| December | 500 |
| January | 500 |
| February | 500 |
| March | 600 |
| April | 900 |
| May | 900 |
| June | 1000 |
| July | 1300 |
| August | 1204 |
| September | 847 |

- Water Level Objectives (Without Facilities)

Water levels at low tide should not be less than zero mean sea level at any point north of Vernalis at any time. Export pump drawdown must not contribute to violations of this objective (SDWA, 115, 1).

- Monitoring Locations (Without Facilities)

SDWA proposes monitoring for water levels and water quality in the San Joaquin River near Vernalis, Mossdale, the bifurcation of Middle River and Old River, Middle River at Howard Road Bridge, San Joaquin River at, or near, the former location of Brandt Bridge, Old River at Tracy Boulevard, Old River at Westside Irrigation District intake; and water level only at the south end of Tom Paine Slough. The water flow should continue to be monitored in the San Joaquin River at Vernalis (SDWA, 115, 1).

- Water Flow and Quality Objectives (With Facilities)

"Water quality required at the inflow points would be specified as a function of net daily inflow rate and of channel depletion by months for the channel reaches receiving water from each inflow point. The values would be initially determined by mathematical modeling of the system to give water quality equivalent to the no barrier standards" (SDWA, 116, 2).

"The required net daily inflow rates at each inflow point would be in accordance with a monthly schedule sufficient to maintain the required unidirectional net daily flow in each channel reach" (SDWA, 116, 2).

- Monitoring Locations (With Facilities)

"Water levels would be monitored at Vernalis, on Old River at Middle Howard Road Bridge, on the San Joaquin River near Paradise Cut, on Old River at Tracy Boulevard, on Grantline Canal at Tracy Boulevard, and at Clifton Court" (SDWA, 116,1).

"Water quality would be monitored at Vernalis, on the downstream (intake) side of each barrier, at the former location of Brandt Bridge on the San Joaquin River north of Old River and Tracy Boulevard. On Grantline Canal, flow would be measured at Vernalis and through each barrier" (SDWA, 116,172).

- Water Level Objectives (With Facilities)

"Water level restraints at the monitoring points would be the same as for the no-barrier case except for an additional required level to be determined on the San Joaquin River south of Paradise Cut. Water level maintenance could also be assisted by seasonally functional flow restrictions in Grantline Canal and in the San Joaquin River Channel near Paradise Cut (SDWA, 116,2).

State Water Contractors (SWC):

- Water Quality Objectives

The SWC recommend changing existing standards to reflect the results of the corn study. Specific recommendations are 1.5 mmhos/cm EC from April 1 through August 15 for all water year types, and 3.0 mmhos/cm EC during critical years (SWC, Brief, I-43).

- Monitoring Locations

The measuring station at Emmaton in the Sacramento River should be relocated to Three Mile Slough upon completion of overland water supply facilities to serve Sherman Island (SWC, Brief, I-43).

Bureau of Reclamation with Support from the U.S. Department of Interior:

- Water Quality Objectives

The USBR presented testimony on the leaching requirements of the five most salt sensitive crops grown in the Delta uplands. These were beans, fruit and nuts, vineyards, corn and alfalfa (USBR, 10 & A&B). From these leaching requirements, average irrigation season water quality objectives of 600 mg/l TDS in a normal year and 800 mg/l TDS in a dry year were developed for Delta agriculture (T, XV, 139:15-139:21). The USBR, however, did not formalize these into recommendations (T, XV, 140:3-140:9).

5.3.3.3 Optimal Level of Protection

Western and Interior Delta:

- Water Quality

- Irrigation Water Quality

Field corn, the most widely grown crop in the Delta, is grown on greater than 21 percent of the total Delta land area including greater than 26 percent of the Delta lowlands (DWR, 304). The optimal level of protection for the western and interior Delta will be based on the protection of corn as it is the predominant crop and among the most salt sensitive crops grown in the area.

The results of the corn study show that, with reasonable farm management practices, an irrigation water EC of 1.5 mmhos/cm will provide 100 percent corn crop yields in Delta organic soils that are subirrigated. An irrigation water salinity of up to 2.0 mmhos/cm EC would provide the same protection for corn on Delta mineral soils. In general, the quality level of 1.5 mmhos/cm EC is met under unimpaired flow conditions at all stations in all year types during the irrigation period of April 1 through August 15. Based on the need and the availability of this quality of water during unimpaired flow conditions, 1.5 mmhos/cm EC is proposed as the optimal level of protection. From information given in Phase I, it has been determined that, even with the adoption of these optimal objectives, Delta farmers will on occasion need to monitor field soil salinity conditions and provide effective leaching to bring the soil salinity to below the threshold value of 3.7 mmhos/cm EC (discussed below) before the start of each irrigation season. Results of the corn study also show that irrigation water salinity may be increased to as much as 6.0 mmhos/cm EC after the end of July without loss in crop yield for that irrigation season. The method of irrigation did not influence the salt tolerance relationship of corn but required increased leaching (SWRCB, 22-24).

- On-Farm

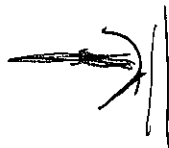

Should the foregoing water quality objectives for irrigation water be adopted, then leaching to remove excess salt buildup will be required. Removal of salt from the crop root zone through leaching will be required when root zone salinity exceeds 3.7 mmhos/cm EC.

- Water Quality Objectives for Leaching

DWR's proposal for a winter ponding objective is appropriate. DWR did not propose a particular level of water quality, but did propose that it be in the form of maximum monthly EC. To protect the Western Delta, this objective should be provided at the Western and interior Delta monitoring agricultural locations for December through February. A maximum monthly EC objective of 1.7 mmhos/cm is recommended for this purpose. This objective is sufficient to provide for the leaching needs throughout the Delta.

- Water Levels

Insufficient information was presented on the negative impacts of water levels and possible solutions to set objectives in the western and interior Delta.

- Location of Objectives

Water quality objectives for the western and interior Delta should be established at the following locations: Emmaton on the Sacramento River, Jersey Point on the San Joaquin River, Terminous on the Mokelumne River, San Andreas Landing on the San Joaquin River, and Cache Slough near Junction Point.

Southern Delta:

- Water Quality

Beans, the most widely grown salt sensitive crop in the southern Delta, were chosen as a target crop for purposes of setting objectives. By setting objectives for this crop, the less salt sensitive crops would also be fully protected. Water quality standards were developed in the Plan for the southern Delta based on bean growth (Table 5.3.3.1-3). As New Melones Reservoir is now operational, the 500 TDS objective at Vernalis is not recommended. The remaining standards, along with a change in the description from a 30-day to a 14-day running average, should provide an optimal level of protection for the southern Delta.

- Water Levels

The issue of protection from low water levels was raised in Phase I of the hearing. Maintaining adequate water levels in the southern Delta can be accomplished through increased

flow releases through regulating export pumping, or through channel modifications. It is believed that structural alternatives combined with dredging and regulating export pumping operations are feasible water level solutions and that no flow objective be set for water levels in the southern Delta.

- Flows

As discussed previously, SDWA requested a schedule of flows for protection of southern Delta agriculture, in addition to minimum water quality standards. Since water quality objectives that will sufficiently protect the crops grown in the southern Delta are being recommended, there is no need for an additional requirement for flows.

- Location for Setting Objectives

The agricultural water quality objectives in the southern Delta should be set at the San Joaquin River near Vernalis and near Mossdale; at the bifurcation of Old and Middle rivers; in Middle River at Howard Road Bridge; in Old River at Tracy Road Bridge; and in the San Joaquin River at the former location of Brandt Bridge.

Bay Agriculture:

Insufficient information was presented in the hearings to set objectives for agriculture in the Bay region.

5.3.3.4 Consideration of Water Availability

- Western and Interior Delta

Figures 5.3.3.4-1 through 5 show the optimal objectives for the western and interior Delta superimposed over unimpaired water quality conditions for an average water year type at selected locations in the western and interior Delta. For the five stations in the western and interior Delta, the 1.5 mmhos/cm EC objective is exceeded at Emmaton only in dry and critical years and at Jersey Point only in critical years.

- South Delta

Figures 5.3.3.4-6 through 11 show the optimal objectives for the southern Delta superimposed over average water year type of unimpaired water quality conditions for selected locations in the southern Delta. All stations in the southern Delta are below the objective of 0.7 mmhos/cm EC through the month of June in all year types. In all cases, July, only the critical years exceed the 0.7 mmhos/cm EC objective. In August through November for most year types, unimpaired water qualities are above the 0.7 mmhos/cm EC objective.

SACRAMENTO RIVER AT EMMATON

MONTHLY MEAN OF YEAR TYPES

FIGURE 5.3.3.4-1

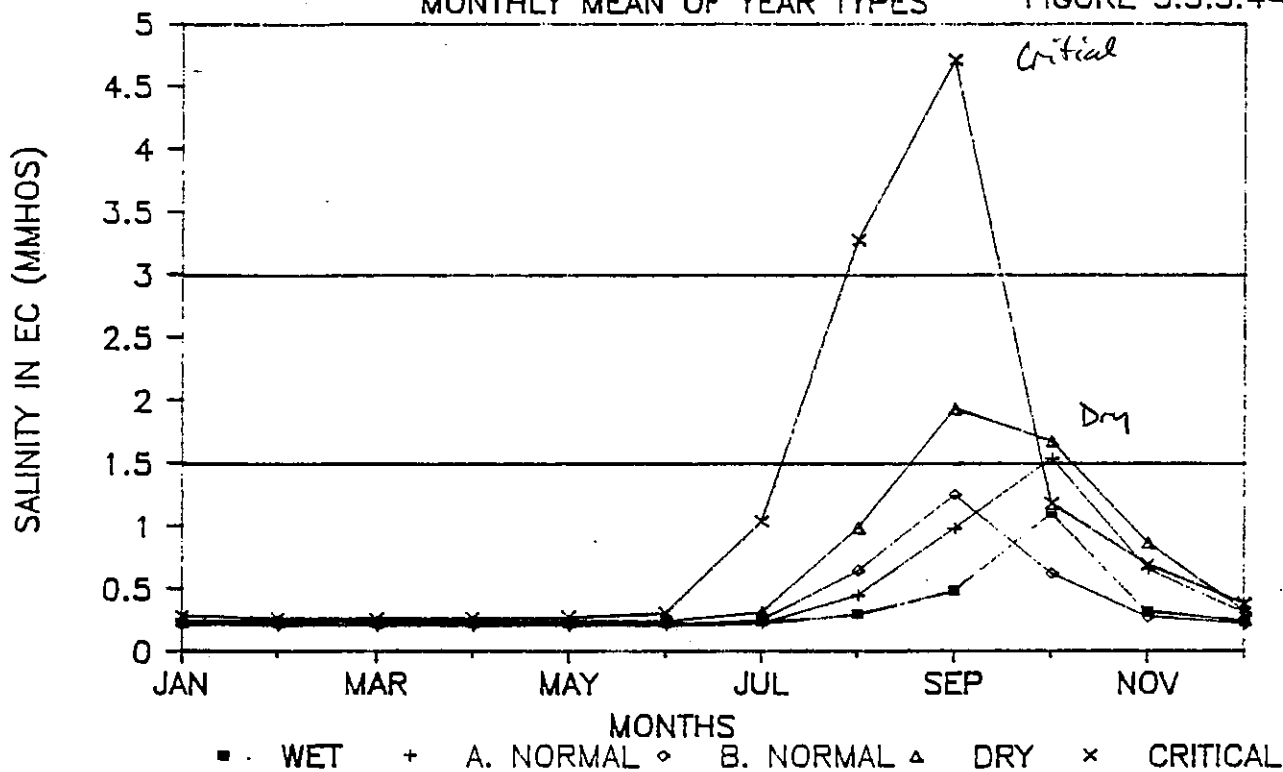

SAN JOAQUIN RIVER AT JERSEY POINT

MONTHLY MEAN OF YEAR TYPES

FIGURE 5.3.3.4-2

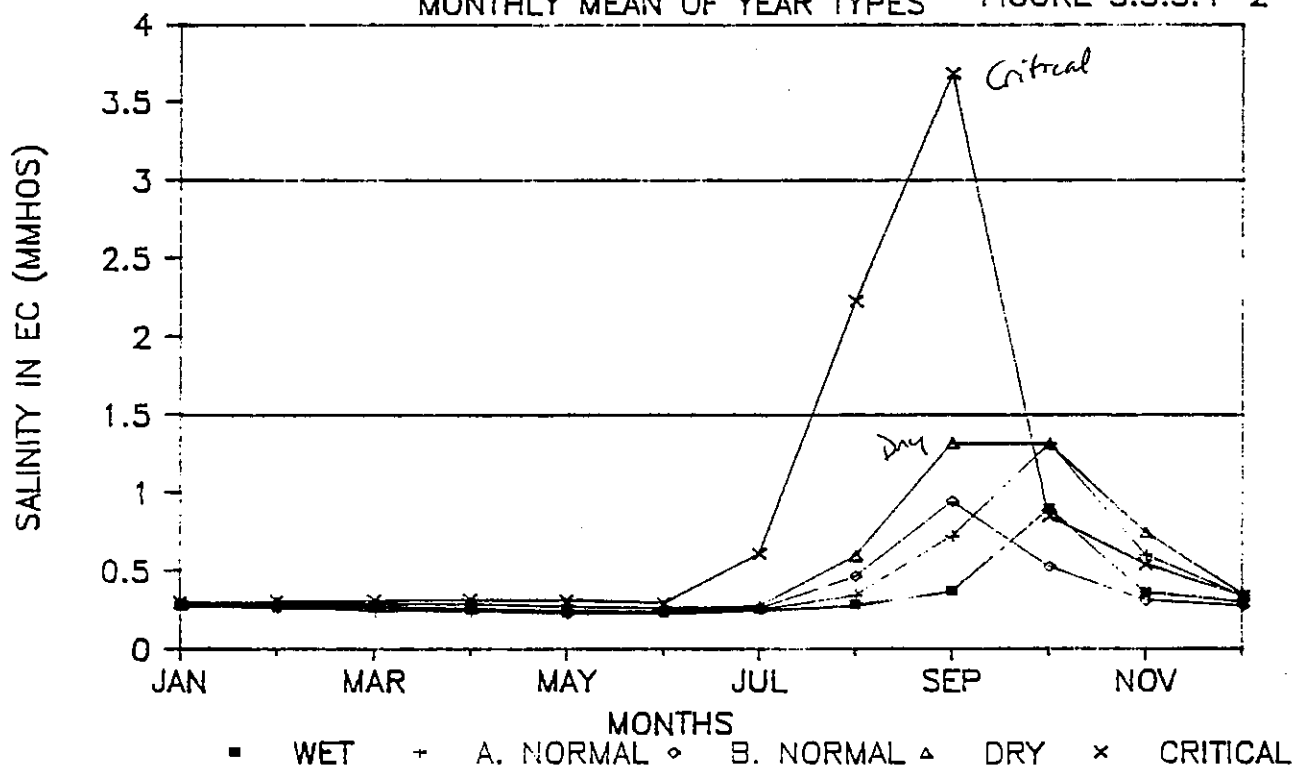

MOKELUMNE RIVER AT TERMINOUS

MONTHLY MEAN OF YEAR TYPES FIGURE 5.3.3.4-3

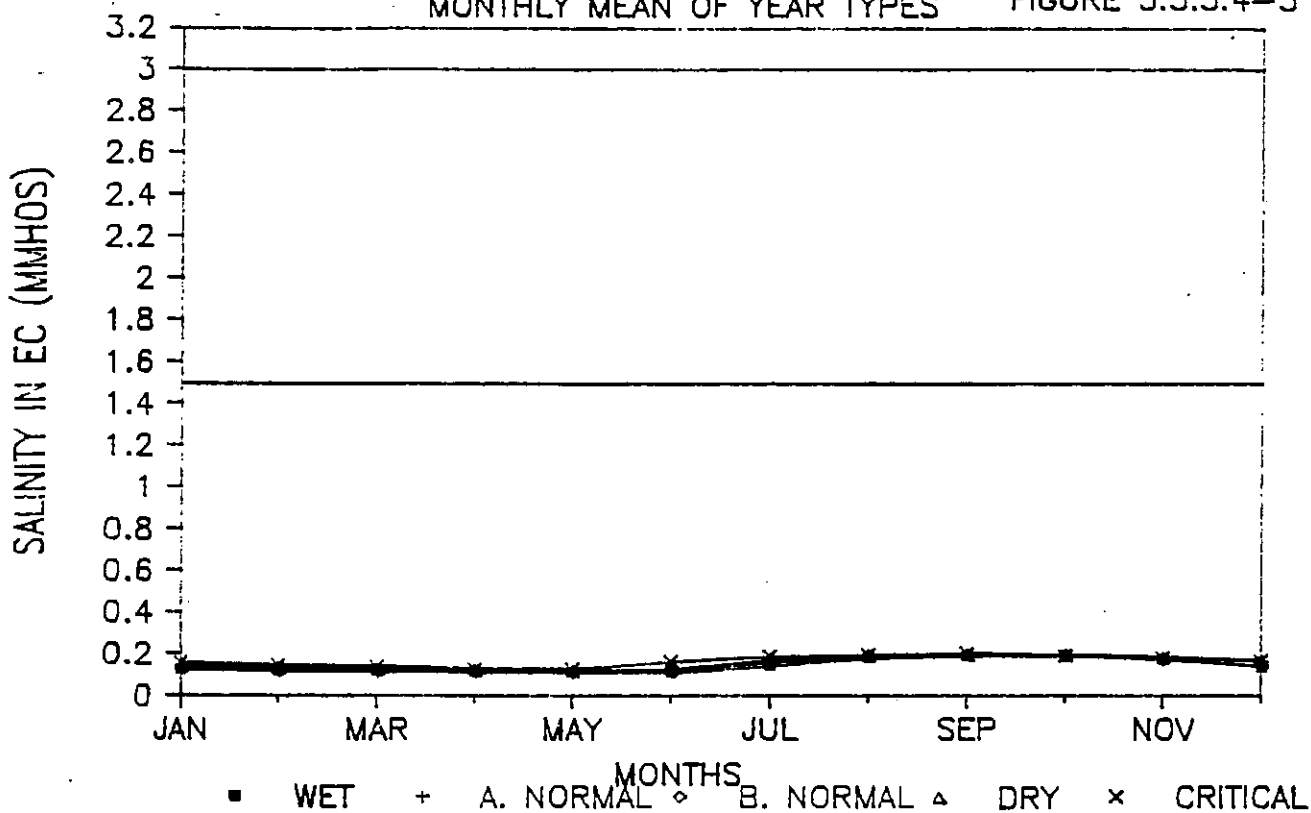

SAN JOAQUIN RIVER AT SAN ANDREAS

MONTHLY MEAN OF YEAR TYPES FIGURE 5.3.3.4-4

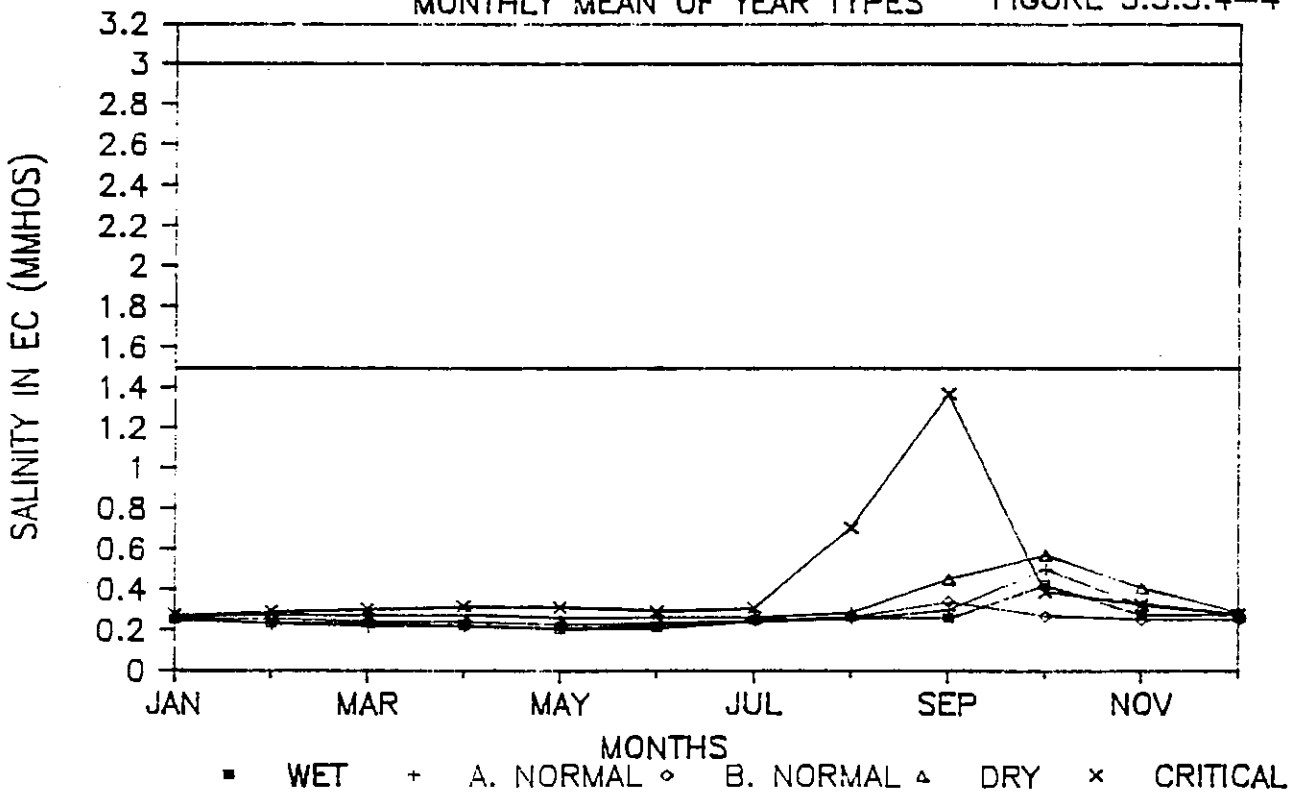

CACHE SLOUGH NEAR JUNCTION POINT

MONTHLY MEAN OF YEAR TYPES

FIGURE 5.3.3.4-5

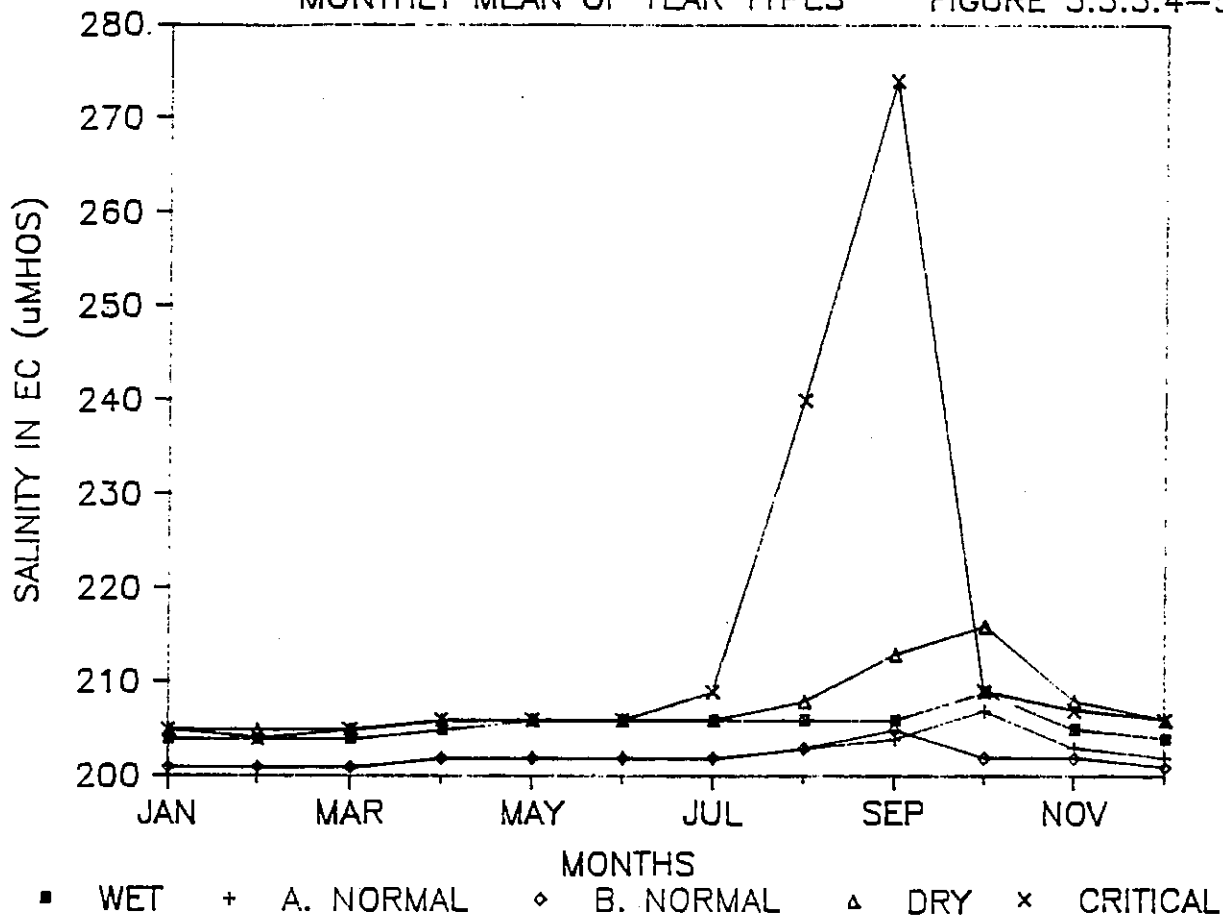

SAN JOAQUIN RIVER AT VERNALIS

MONTHLY MEAN OF YEAR TYPES FIGURE 5.3.3.4-6

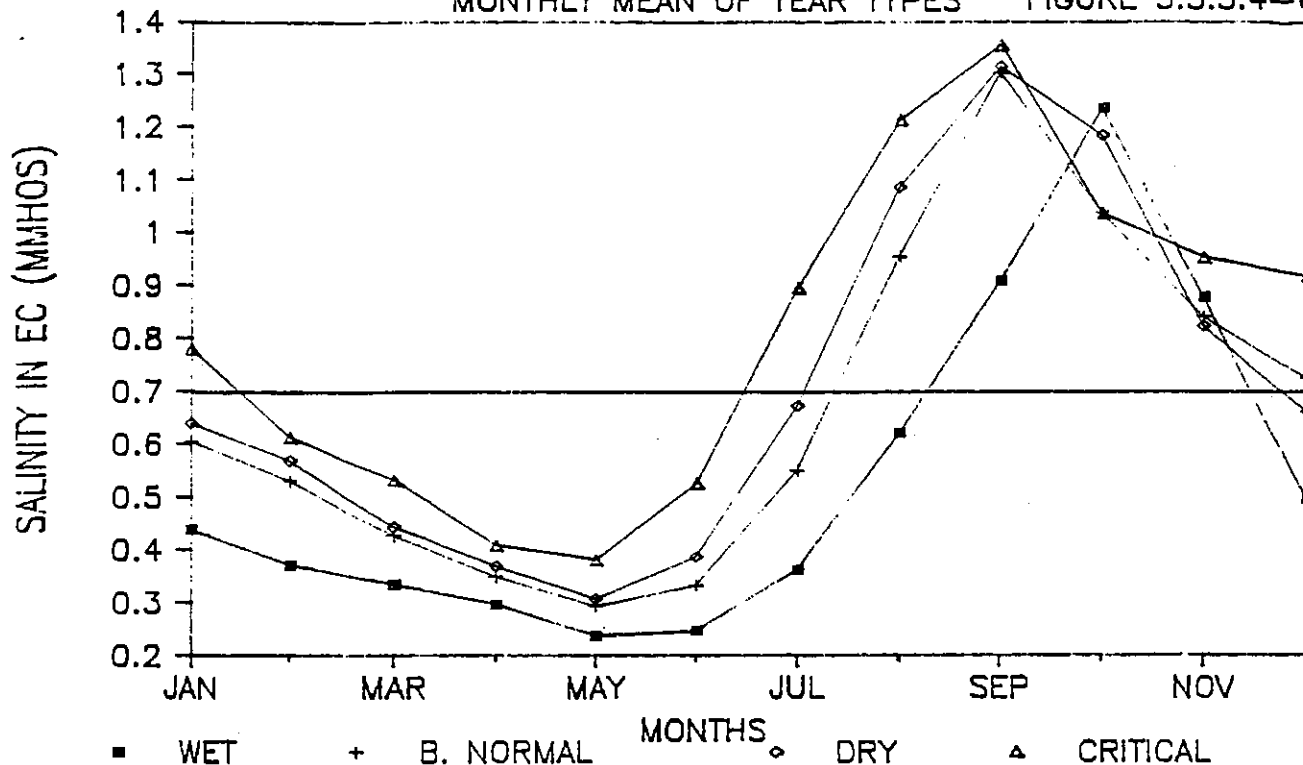

SAN JOAQUIN RIVER AT MOSSDALE

MONTHLY MEAN OF YEAR TYPES FIGURE 5.3.3.4-7

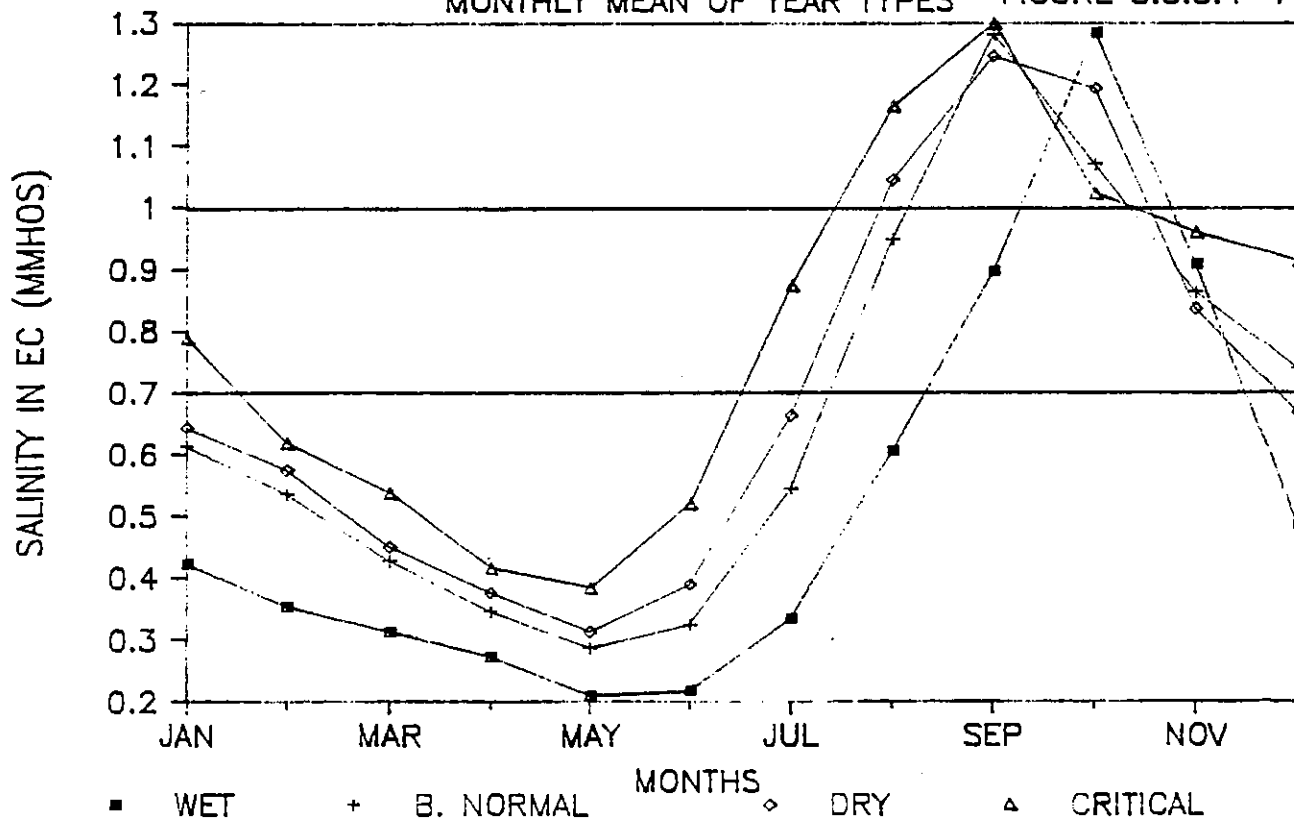

BIFURCATION OF OLD AND MIDDLE RIVER

MONTHLY MEAN OF YEAR TYPES FIGURE 5.3.3.4-8

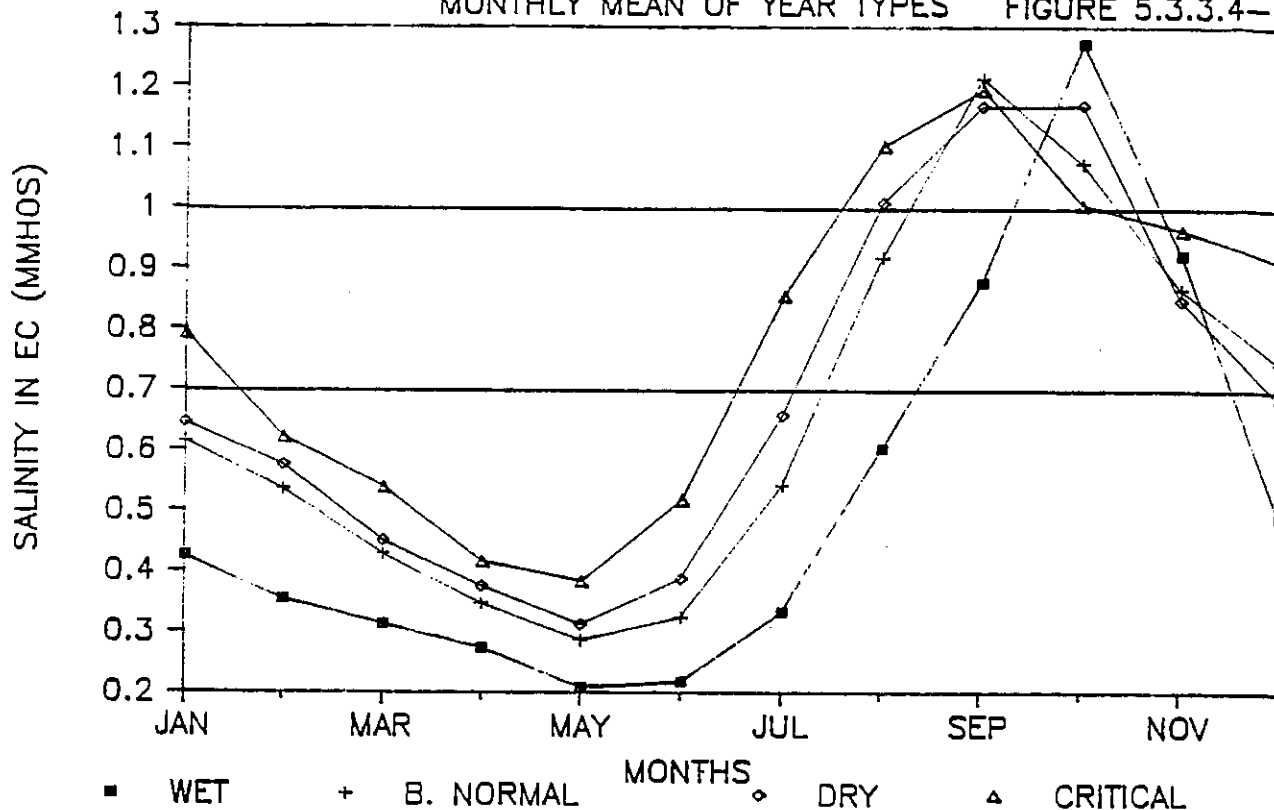

SAN JOAQUIN AT BRANDT BRIDGE

MONTHLY MEAN OF YEAR TYPES FIGURE 5.3.3.4-9

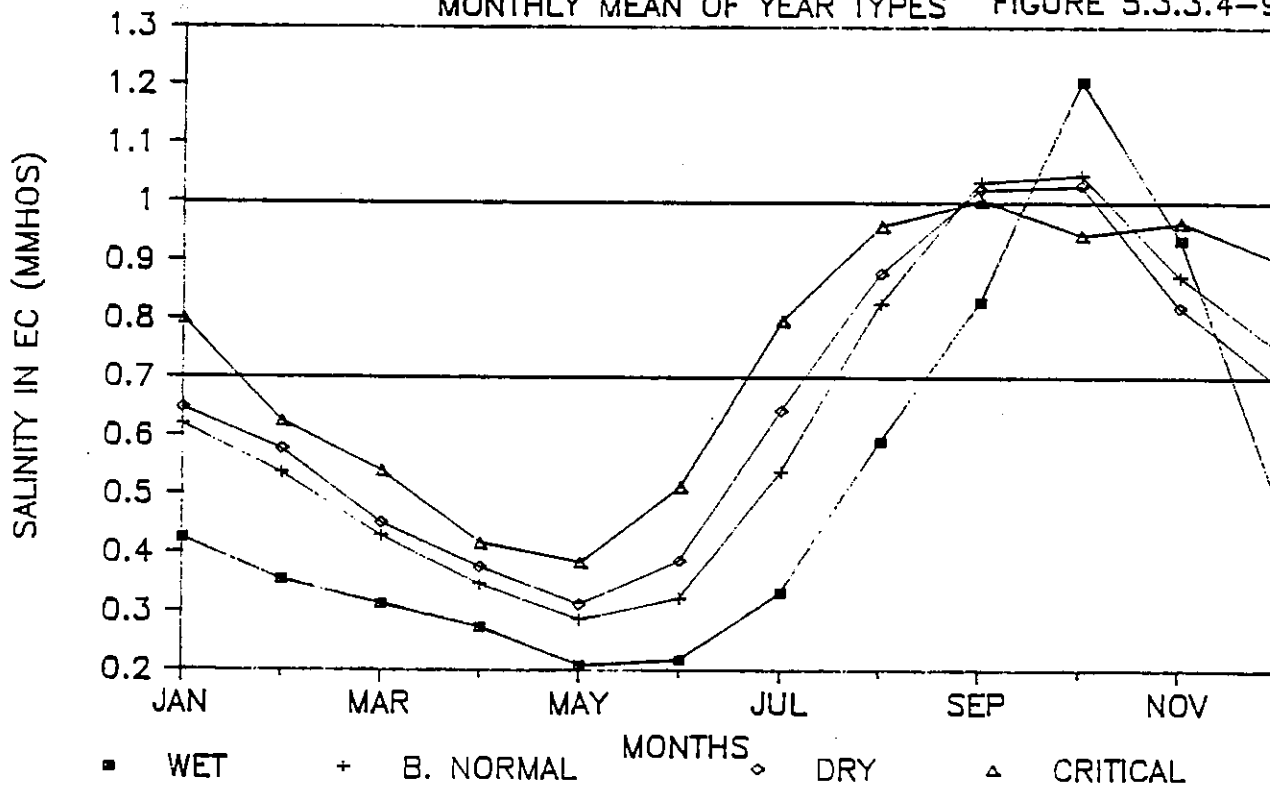

MIDDLE RIVER AT HOWARD ROAD BRIDGE

MONTHLY MEAN OF YEAR TYPES FIGURE 5.3.3.4-10

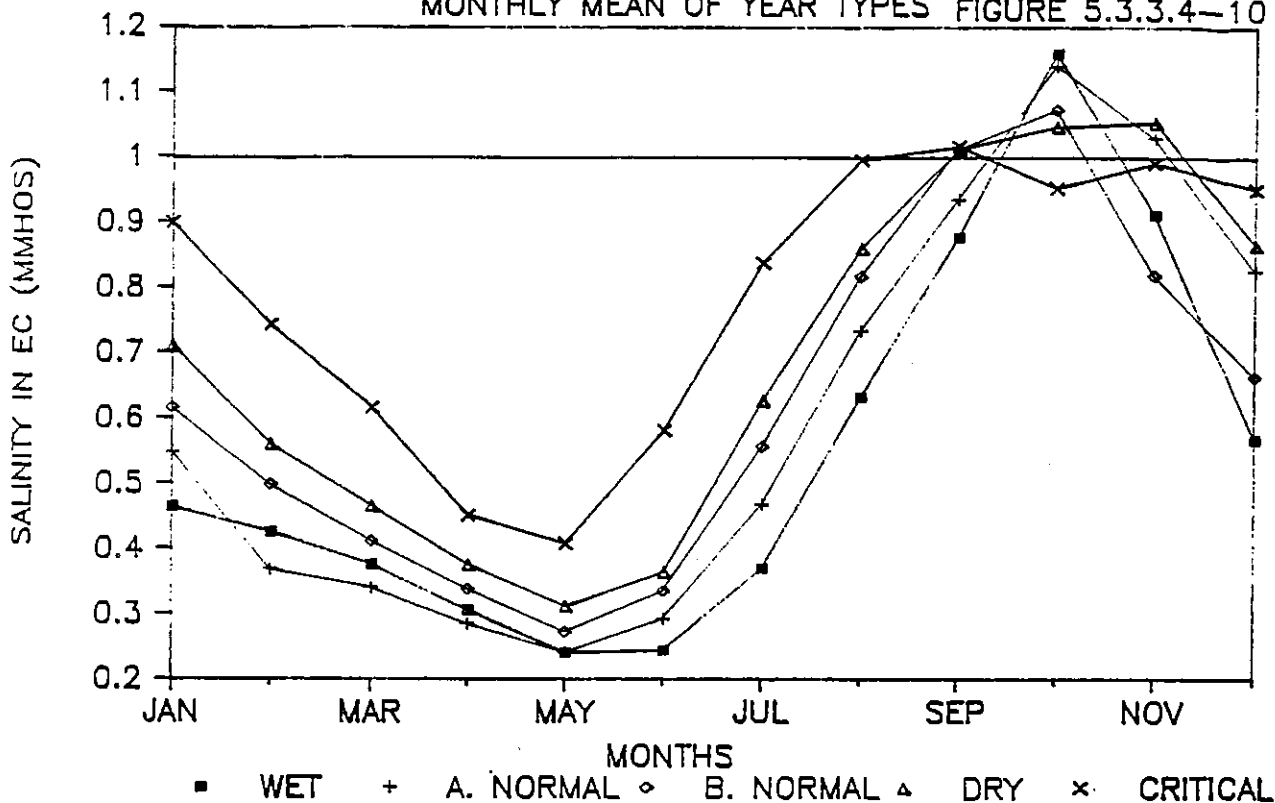

OLD RIVER AT TRACY ROAD BRIDGE

MONTHLY MEAN OF YEAR TYPES FIGURE 5.3.3.4-11

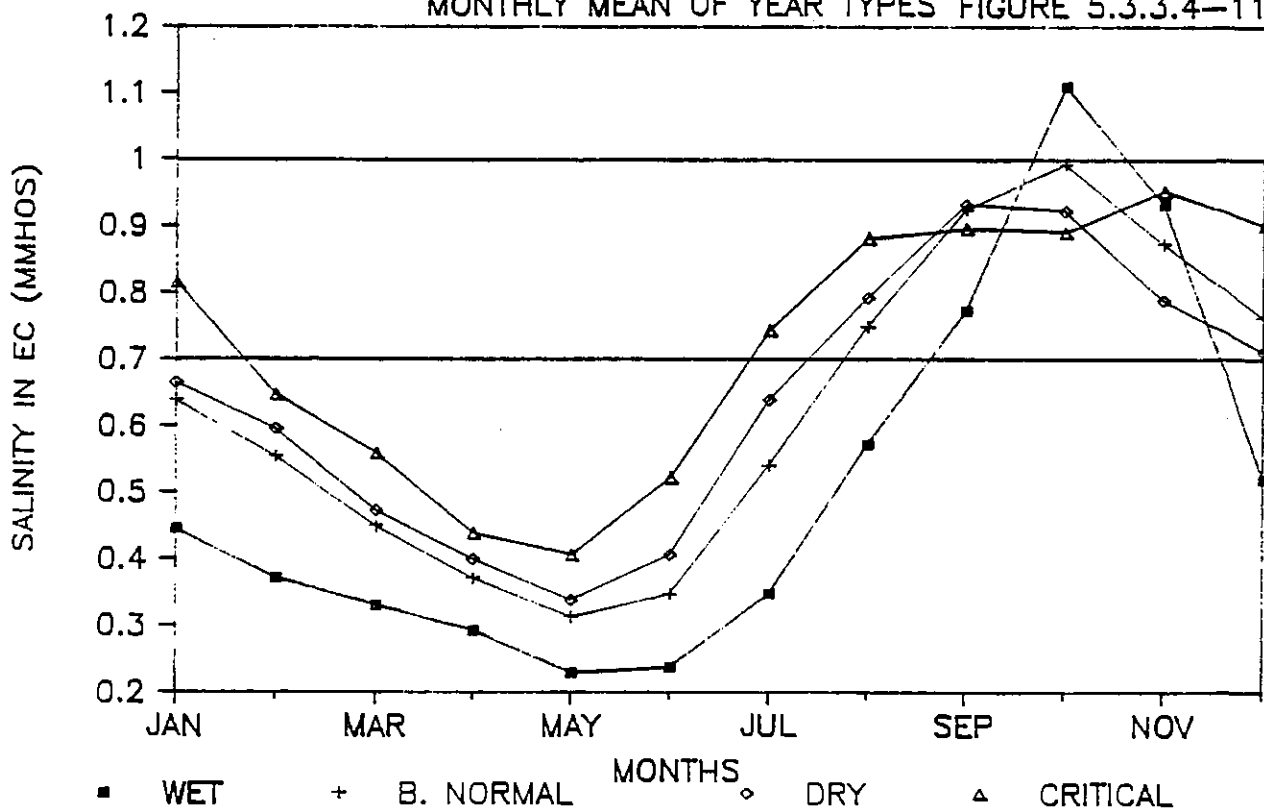

- San Francisco Bay Agriculture

Until additional information is obtained that identifies the needs of Bay agriculture, no objectives can be set for Bay agriculture.

The optimal level of protection for agricultural beneficial uses in the Delta is presented in Table 5.3.3.4.-1.

5.3.4 Chinook Salmon

5.3.4.1 No Action Alternative

The 1978 Delta Plan contains flow objectives for the protection of Chinook salmon migration throughout the year in the Estuary. These standards are 30 day running averages of daily flows at Rio Vista (see Table 5.3.4.1-1) which provide protection of Sacramento River Basin salmon. Special agreements, not included in the Delta Plan, which provide protection to salmon are discussed in Section 5.3.4.3. Figure 5.3.4.1-1 is a schematic representation of the location of sites, facilities and channels to be discussed.

The Delta Plan also requires the SWP and CVP, in all water year types, to close the Delta Cross Channel gates at Walnut Grove when the daily Delta Outflow Index at Chipps Island exceeds 12,000 cfs between January 1 and April 15. The intent is to minimize diverting fry, which rear in the north Delta, into the central or southern Delta. Under the Delta Plan's striped bass standards, DFG can request that the gates be closed between April 16 through May 31 for up to 20 days but not more than two out of four consecutive days. Such closures provide incidental protection for emigrating smolts.

The Delta Plan contains limitations and/or requirements for operation of SWP and CVP fish protective facilities at their respective Delta pumping plants and for maintenance of fish salvage records (SWRCB, 1978, 40). The Delta Plan operational criteria for the fish protection facilities, however, apply to the CVP secondary fish screening system only to the extent that they are compatible with water export rates.

The Delta Plan limits total Delta exports to 6,000 cfs for both the CVP and SWP (3,000 cfs each) in May and June for striped bass protection. However, the entire San Joaquin River flow may be diverted in May and June of most years (T, XXXVI, 166:13-19) when exports exceed San Joaquin River inflows. As exports increase relative to inflows, more of this River's flow is drawn towards the CVP and SWP pumps via Old River (DFG, 15, 28; DWR, 50) (see Figure 5.3.4.1-2) and flows in the lower reaches of Old, Middle, and the San Joaquin rivers may reverse and move upstream towards the export pumps.

TABLE 5.3.3.4-1
OPTIMAL LEVEL OF PROTECTION FOR
AGRICULTURAL USES

| Beneficial Use Protected and Location | Parameter | Description | Year Type | Dates | Values or Limit |
|--|-------------------------|--|-----------|--------------------------|-----------------|
| AGRICULTURE | | | | | |
| Western and Interior Delta Irrigation Sacramento R. at Emmaton San Joaquin R. at Jersey Point Mokelumne R. at Terminus San Joaquin R. at San Andreas Ldg. Cache Sl. at Junction Pt. | Electrical Conductivity | Maximum 14-Day Running Average Mean Daily EC, mmhos/cm | All | 4/1 - 8/15 | EC 1.5 |
| South Delta Irrigation San Joaquin R. near Vernalis San Joaquin R. at Mossdale Bifurcation of Old and Middle rivers Middle R. at Howard Rd. Bridge Old R. at Tracy Rd. Bridge San Joaquin R. at former site of Brandt Bridge | Electrical Conductivity | Maximum 14-Day Running Average Mean Daily EC, mmhos/cm | All | 4/1 - 8/31 9/1 - 3/31 | 0.7 1.0 |
| Delta Leaching (Ponding) Emmaton Jersey Point Cache Slough at Junction Point San Andreas Landing | Electrical Conductivity | Maximum monthly average of mean daily EC, mmho/cm | All | 12/1-2/28 | 1.7 |

5-26

Table 5.3.4.1-1--1978 Delta Plan Salmon Standards

I. Salmon Migration-30 Day Running Average
of Mean Daily Flow at Rio Vista in cfs
Water Year Type

| Time Period | Wet | Above Normal | Below Normal | Dry | Critical |
|-----------------------------|-------|--------------|--------------|-------|----------|
| January | 2,500 | 2,500 | 2,500 | 1,500 | 1,500 |
| February 1- March 15 | 3,000 | 2,000 | 2,000 | 1,000 | 1,000 |
| March 16- June 30 | 5,000 | 3,000 | 3,000 | 2,000 | 2,000 |
| July | 3,000 | 2,000 | 2,000 | 1,000 | 1,000 |
| August | 1,000 | 1,000 | 1,000 | 1,000 | 1,000 |
| September 1- December 31 | 5,000 | 2,500 | 2,500 | 1,500 | 1,500 |

II. Cross Delta diversion of salmon fry

Jan 1-Apr 15

Close Delta Cross Channel Gates
at Delta Outflow Index > 12,000 cfs

III. CVP and SWP Delta pumping plant fish protective facilities

SWP
Nov 1-May 14

CVP
*Feb-May
**June-Aug 31^{1/}

- | | |
|---|---|
| <p>(a) approach velocity 3.0-3.5 fps</p> <p>(b) bypass ratio-1.2:1.0 to 1.6:1.0 in primary and secondary channels</p> <p>(c) primary bay-use Bay B as first choice</p> <p>(d) velocity of water exiting the screened water system not to exceed secondary channel approach velocity</p> | <p>Secondary system to be operated as shown below to the extent compatible with export rates:</p> <p>*(a) secondary velocity 3.0-3.5 fps</p> <p>** (b) secondary velocity not to exceed 2.5 fps (preferably 1.5 fps). secondary velocity ratio not reduced below 1:1.0</p> <p>(c) screened water discharge to lowest possible level consistent with its purpose</p> <p>(d) bypass ratio in the secondary should prevent excessive velocities in the holding tanks but should not be less than the secondary approach velocity</p> |
|---|---|

^{1/}Applies to all fish

FIGURE 5.3.4.1-1 Schematic representation of the Delta and experimental smolt release sites

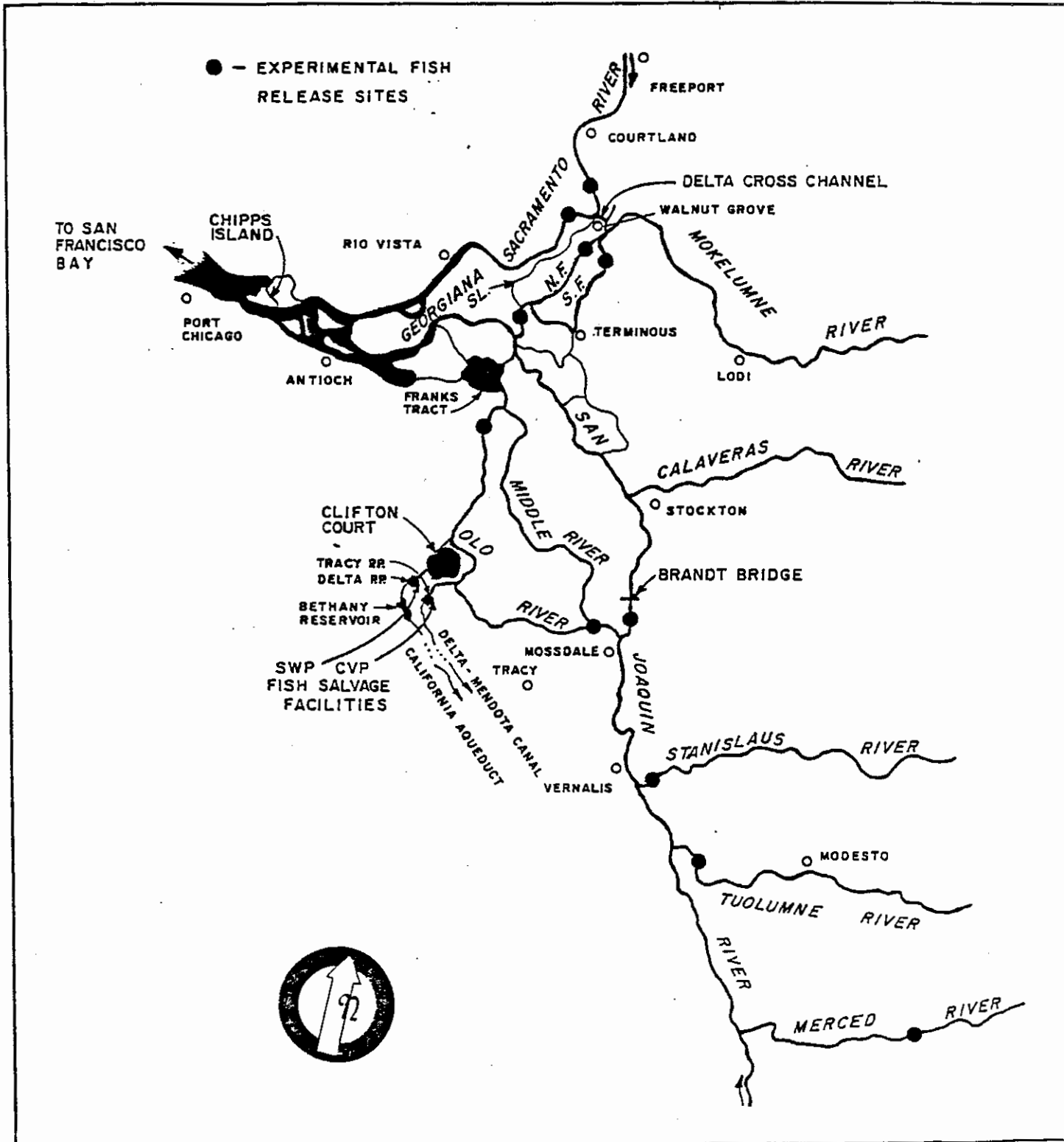
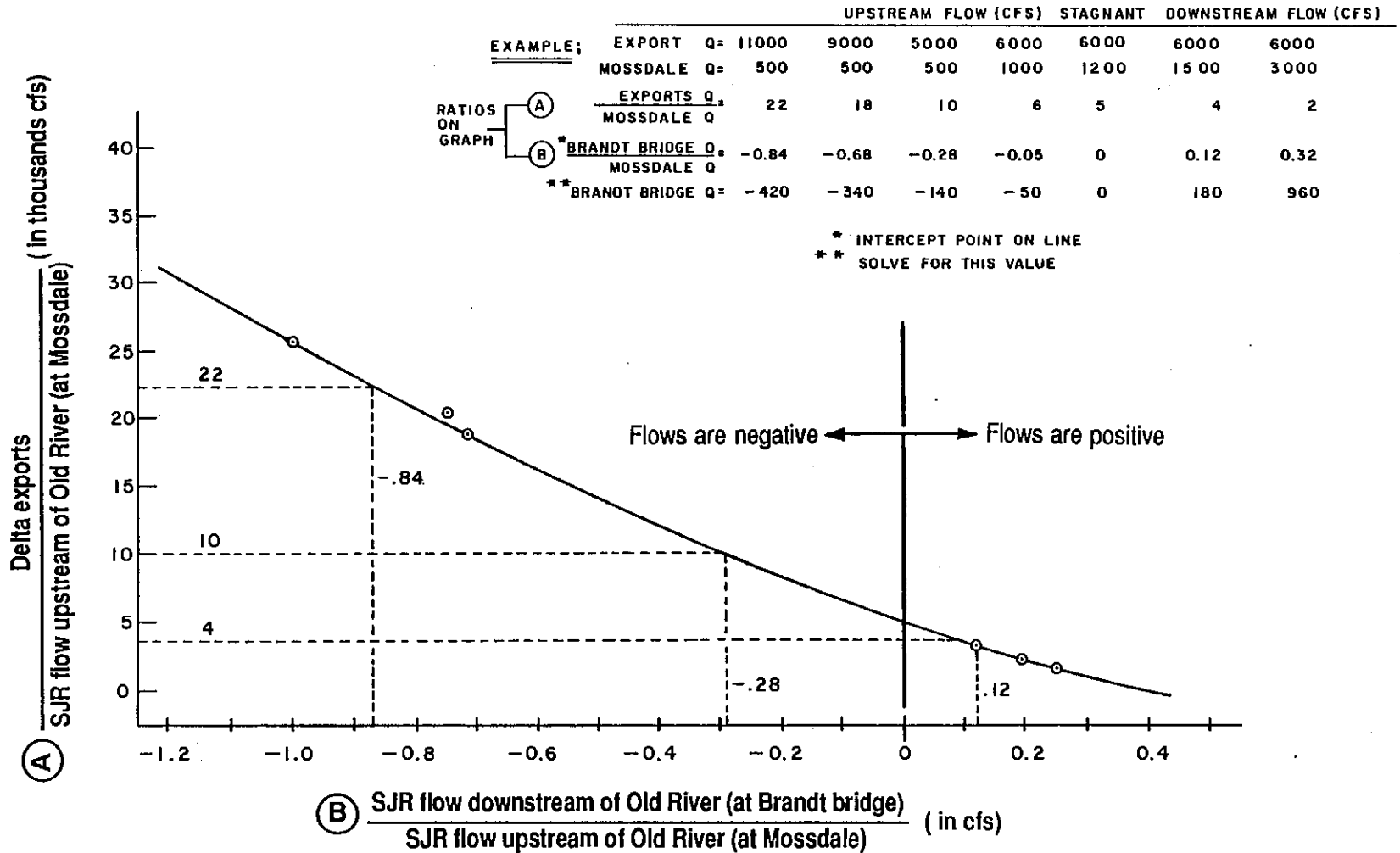

FIGURE 5.3.4.1-2 Relationship between Delta exports and flows in the San Joaquin River upstream and downstream of its confluence with Old River. This shows that as Delta exports increase relative to San Joaquin River inflows at Mossdale, flows downstream at Brandt Bridge will reverse and flow upstream (T, I I, 194:1-197:13) (from DWR 50)



Smolts of the four Chinook salmon races are emigrating through the Delta from about October through June, with the greatest abundance typically from April through June when the fall run emigrates. Average monthly salvage of Chinook salmon at the Harvey O. Banks Delta Pumping Plant reflects this seasonal abundance of young salmon in the Estuary (see Figure 4.5.1.2-3) (T, XXXVII, 128:13-129:1).

Since the 1978 Delta Plan was approved, the survival of fall run smolts emigrating through the Estuary to the ocean has been identified as an issue of concern. Little information was available during the hearing for this plan. Since then, the USFWS on behalf of the Interagency Ecological Studies Program, carried out studies to evaluate the survival of fall run smolts during their emigration through the Estuary. These studies provide significant new information about relationships between smolt survival and Delta conditions under the 1978 Delta Plan, which are discussed in detail in section 5.3.4.3. USFWS has concentrated on Delta conditions affecting fall run smolts emigrating from the Sacramento River Basin. Generally they found that smolt survival improved with increasing flow, up to a maximum. Limited data from studies of San Joaquin Basin smolts show similar results. Evidence was not presented on the effects of existing estuarine conditions on the immature life stages of the other three races of Chinook salmon.

The recent evidence developed by USFWS indicates that, if the 1978 Delta Plan salmon migration flows were the controlling flow standard, fall run smolt survival would be minimal (see Table 5.3.4.1-2). However, under present conditions, other water quality standards and operational constraints on the SWP and CVP result in substantially higher flows during the April through June fall run smolt emigration period. Currently flow requirements to protect agricultural, fish and wildlife, and striped bass beneficial uses provide higher flows than those required for salmon migration (see Table 5.3.4.1-3). Uncontrolled flows during, and sometimes later than, April in wetter water years, also contribute to Rio Vista flows exceeding 1978 Delta Plan requirements (see Table 5.3.4.1-4).

Very little information is available about the effects of present conditions on salmon smolts migrating through the Bay. Information on Bay survival will not be available for several years.

5.3.4.2 Advocated Levels of Protection

Most of the parties presenting testimony on Chinook salmon agree that the 1978 Delta Plan salmon flow standards provide inadequate protection for fall run smolts, and that specific causes of salmon mortality upstream and in the Delta should be addressed to improve survival rates of immature fish. Most participants analysed the same data in preparing their testimony. The major differences dealt with: (1) when, where,

Table 5.3.4.1-2--Estimated Survival^{1/}Index Values Under 1978 Delta Plan
 Salmon Migration Flow Standards during April-June

| Time Period | Water Year Type | | | | | | | | | |
|-------------------|-----------------|-------------------|---------------|-------------------|---------------|-------------------|---------------|-------------------|---------------|-------------------|
| | Wet | | Above Normal | | Below Normal | | Dry | | Critical | |
| | Flow (cfs) | Survival Index | Flow (cfs) | Survival Index | Flow (cfs) | Survival Index | Flow (cfs) | Survival Index | Flow (cfs) | Survival Index |
| April- June 30 | 5,000 | 0.02 | 3,000 | 0.0 | 3,000 | 0.0 | 2,000 | 0.0 | 2,000 | 0.0 |

^{1/}Survival=0.000056Q-0.258 where Q=Rio Vista flows from 4,600-22,000 cfs (from USFWS,31)

Table 5.3.4.1-3--Estimated Controlling Delta Outflows^{1/} Under the 1978 Delta Plan During Fall Run Smolt Migration Period. Values in parentheses are the estimated survival index values (from USFWS,31) if these flows occurred at Rio Vista

| Time Period | Water year Type | | | | | Mean Smolt Survival |
|---------------|---|--|--|--------------------------------|--|---------------------|
| | Wet | Above Normal | Below Normal | Dry | Critical | |
| April | Flow in cfs 10,000 (0.30) | Flow in cfs 7,600 (0.17) | Flow in cfs 7,600 (0.17) | Flow in cfs 7,600 (0.17) | Flow in cfs 4,500 - 6,700 ^{3/} (0.0 - 0.12) | 0.16-0.19 |
| May 1-5 | Flow in cfs 10,000 (0.30) | Flow in cfs 7,600 (0.17) | Flow in cfs 7,600 (0.17) | Flow in cfs 7,600 (0.17) | Flow in cfs 4,500 - 6,700 ^{3/} (0.0 - 0.12) | 0.16-0.19 |
| May 6-31 | Flow in cfs 7,600 - 14,000 ^{2/} (0.17 - 0.53) | Flow in cfs 7,600 - 14,000 ^{2/} (0.17 - 0.53) | Flow in cfs 7,600 - 11,400 ^{2/} (0.17 - 0.38) | Flow in cfs 7,600 (0.17) | Flow in cfs 3,900 (0.0) | 0.14-0.32 |
| June 1-15 | Flow in cfs 7,600 - 14,000 ^{2/} (0.17 - 0.53) | Flow in cfs 7,600 - 10,700 ^{2/} (0.17 - 0.34) | Flow in cfs 7,600 - 9,500 ^{2/} (0.17 - 0.27) | Flow in cfs 7,600 (0.17) | Flow in cfs 3,900 (0.0) | 0.14-0.26 |
| June 16-20 | Flow in cfs 7,600 - 14,000 ^{2/} (0.17) - 0.53) | Flow in cfs 7,600 - 10,700 ^{2/} (0.17 - 0.34) | Flow in cfs 7,600 - 9,500 ^{2/} (0.17 - 0.27) | Flow in cfs 4,700 (0.01) | Flow in cfs 3,900 (0.0) | 0.10-0.23 |
| June 21-30 | Flow in cfs 7,600 - 14,000 ^{2/} (0.17 - 0.53) | Flow in cfs 7,600 - 10,700 ^{2/} (0.17 - 0.34) | Flow in cfs 5,400 - 9,500 ^{2/} (0.04 - 0.27) | Flow in cfs 4,700 (0.01) | Flow in cfs 3,900 (0.0) | 0.08-0.23 |
| Mean Survival | 0.21-0.45 | 0.17-0.31 | 0.15-0.25 | 0.12 | 0-0.04 | 0.13-0.24 |

1/ Flow Estimates derived from DWR, personal communication, to R. Satkowski, SWRCB, dated 2/9/88.

2/ If subnormal snowmelt lower value applies.

3/ If SWP and CVP users are taking deficiencies in firm supplies lower value applies.

5-32

Table 5.3.4.1-4--Comparison of Mean Monthly Controlling
Delta Outflows and Actual Delta Outflows
in cfs (from DWR Dayflow).

| Water Year | Year Type | April | | May | | June | |
|---------------|--------------|---------|---------------------------|--------|-------------|--------|-------------|
| | | Actual | Controlling ^{1/} | Actual | Controlling | Actual | Controlling |
| 77-78 | W | 61,276 | 10,000 | 40,874 | 13,360 | 9,086 | 14,000 |
| 78-79 | D | 14,485 | 7,600 | 13,435 | 7,600 | 5,326 | 6,150 |
| 79-80 | W | 28,689 | 10,000 | 20,912 | 13,360 | 14,870 | 14,000 |
| 80-81 | D | 11,653 | 7,600 | 9,143 | 7,600 | 4,596 | 6,150 |
| 81-82 | W | 140,163 | 10,000 | 57,876 | 13,360 | 28,515 | 14,000 |
| 82-83 | W | 113,053 | 10,000 | 97,996 | 13,360 | 72,154 | 14,000 |
| 83-84 | W | 14,732 | 10,000 | 11,204 | 7,984 | 8,038 | 7,600 |
| 84-85 | D | 6,913 | 7,600 ^{3/} | 7,378 | 7,600 | 5,215 | 6,150 |
| 85-86 | W | 46,572 | 10,000 | 15,911 | 13,360 | 9,322 | 14,000 |
| 86-87 | C | 6,291 | 6,700 | 4,951 | 4,348 | 3,496 | 3,900 |

^{1/}Controlling or minimum required Delta Outflow flows as shown on Table 5.3.4.1-3 from DWR tables revised March 1986 sent to R. Satkowski of SWRCB, 1/9/88. If controlling flow varies within the month each flow is weighted by the number of days in that month for which it applies. Carriage water is not included in these values.

^{2/}Subnormal snowmelt criteria apply.

^{3/}Differences due to imprecision in channel depletion estimates and correlations between flow and EC used to determine minimum required Delta Outflow. These do not represent violations of Delta Plan standards.

and what actions should be taken; and (2) which factors were considered the most influential on adult and/or young salmon survival and production. Only the fishery agencies and environmental groups advocated levels of protection essentially different from those of the 1978 Delta Plan.

The positions taken by the parties at Phase I of the hearing on Chinook salmon are summarized below and in Tables 5.3.4.2-1 through 5.3.4.2-4:

- SWC (SWC, 201, 22-27; T, LIX, 170:7-173:13)
 - Existing Delta Plan striped bass flow standards should be maintained as the salmon flow objectives until adequate data are available to determine whether changes are required.

Table 5.3.4.2-1 shows what the striped bass flows would be from May 6 through June under the 1978 Delta Plan and represents an estimate of the levels of protection advocated by the SWC, USBR, and DWR. USFWS data were used to calculate the estimated smolt survival index under these flows to compare with levels of protection advocated by other parties. For comparison, Table 5.3.4.1-3 gives an estimate of controlling flows during the entire April through June smolt emigration period.

- DWR (T, XLIII, 219:2-221:8)
 - The existing striped bass standards should be the salmon standards.
 - Recent historical levels of catch and escapement are already being maintained.
- USBR (T, LXI, 120:24-131:6)
 - Natural salmon production should be increased.
 - A system-wide management plan that addresses conditions in all salmon habitats should be developed.
 - Structural solutions, such as screens, to improve Delta survival would be preferred to flow increases since they would minimize impacts on other beneficial uses.
 - Continue interagency studies and refine monitoring to determine effectiveness of new programs.
 - Allow operational flexibility to respond to recommendations of the five-agency salmon group, composed of the USFWS, DFG, NMFS, DWR and USBR, recently formed to reduce or solve salmon problems identified in the Phase I hearings.

Table 5.3.4.2-1--Recommended Salmon Flow Standards with present Delta Plan
Delta Outflows for Striped Bass (SWC, USBR, DWR).
(USFWS survival index values are shown in parentheses).

| Period | Water Year Type | | | | | |
|----------|------------------|------------------|------------------|-----------------------|-------------------|----------------------------------|
| | Wet | Ab. Norm. | B. Norm. | Subnormal Snowmelt | Dry ^{1/} | Dry or Critical ^{2/} |
| | Flow in cfs | | | | | |
| May 6-31 | 14,000 (0.53) | 14,000 (0.53) | 11,400 (0.38) | 6,500 (0.11) | 4,300 (0.0) | 3,300 (0.0) |
| June | 14,000 (0.53) | 10,700 (0.34) | 9,500 (0.27) | 5,400 (0.04) | 3,600 (0.0) | 3,100 (0.0) |

^{1/}Dry year following a wet, above normal or below normal year,
from D-1485 Table 2

^{2/}Dry year following a dry or critical year

- Do not change existing standards until the recommendations of the five-agency salmon group can be evaluated.
- DTAC, TID/MID (TID/MID, Brief, 9-14)
 - The smolt survival index should not be used as a standard.
- USFWS (USFWS, 31, 31d-j and 47)
 - Sacramento Basin fall run smolts should be protected April 1 through June 30 and San Joaquin Basin smolts from April 1 through June 15.
 - Sacramento River flows at Rio Vista, depending on water year type, should range from 21,500-10,000 cfs and provide smolt survival indices at the 1940's level, ranging from 0.95 in wet years to 0.30 in critical years.
 - San Joaquin River flows at Vernalis should range from 12,000-4,000 cfs, depending on water year type.
 - Eliminate reverse flows during smolt emigration.
 - Prevent delays to adult migrants, maintain unobstructed migration route, and maintain DO above 5 mg/l between Stockton and Turner Cut in the fall.
 - Survival goals could be achieved by a combination of flow, operational and physical modifications.

Table 5.3.4.2-2 summarizes the protection levels recommended by USFWS and other fishery advocates.

- NMFS (T, LXI, 22:24-28:4)
 - In the Sacramento River system, Delta smolt survival for all four races should be that which occurred under 1940 levels of water development (see Table 5.3.4.2-2).
 - The Water Quality Control Plan should contain a blend of physical and operational management measures as well as some increment of flow increase to improve smolt survival.
 - Interim standards should be established for the San Joaquin River system to improve salmon production.
- DFG (T, XLIII, 76:24-80:24; DFG, 64, and DFG, 30)
 - Survival of each race in the Delta should be based on 1940 historical levels (see Table 5.3.4.2-2).

Table 5.3.4.2-2--Recommended Objectives for Chinook Salmon (USFWS,DFG,NMFS)
(from USFWS,31d-i and 47)

| Water Year Type | <u>Sacramento Basin Smolts</u> | |
|--------------------|--------------------------------|---|
| | April - June Survival Index | April - June Rio Vista Flow (CFS) |
| Wet | 0.95 | 21,500 |
| Above Normal | 0.85 | 20,000 |
| Below Normal | 0.75 | 18,000 |
| Dry | 0.65 | 16,000 |
| Critical | 0.30 | 10,000 |

1. Keep smolts out of central Delta.
2. Keep temperatures below 66 degrees F.
3. Keep smolts out of upper Old River.
4. Positive net flow in the San Joaquin, Old, and Middle rivers.

San Joaquin Basin Smolts

1. Same survival levels as for the Sacramento Basin.
2. Vernalis in flows ranging from 12,000 cfs in wet water years to 4,000 in critical water years.

Central Valley Adults

1. Maintain unobstructed migration route.
2. Dissolved oxygen \geq 5 mg/1 between Stockton and Turner Cut on the San Joaquin River.

- Survival rate for Sacramento Basin fall run salmon should be based on the USFWS flow-to-survival relationship in Exhibit 31.
 - Eliminate flow reversals by 1995 in the San Joaquin River and in Old and Middle rivers.
 - Survival levels in the San Joaquin River should also be based on historical levels but these still need to be defined.
 - Physical and operational measures should be considered to achieve protection.
- EDF (EDF, 23)
 - USFWS flows recommended for Sacramento Basin smolt migration should be adopted.
 - Vernalis flows should range from 11,000-5,000 cfs depending on water year type.
 - Delta outflows should range from 31,000-10,000 cfs, depending on water year type.

Table 5.3.4.2-3 summarizes the flow conditions recommended by EDF.

- BISF (BISF, Brief, 85-86 and 93-98)
 - The spring Delta outflows at Chipps Island, measured as a combination of Sacramento and San Joaquin River flows, should not be less than 38,500 cfs averaged over three to five year periods.
 - Outflows could be reduced in dry years provided compensating flows are available in other years.
 - There should be objectives for wet, median and dry year spring flows at levels greater than D-1485.
 - Endorses other measures proposed by USFWS.

Table 5.3.4.2-4 summarizes the standards recommended by BISF.

5.3.4.3 Optimal Levels of Protection

Evidence presented in Phase I of the hearing indicates that Delta Plan objectives do not fully protect all the different life stages of Chinook salmon using the Estuary. The parties presenting evidence at the hearing reviewed much of the same data and generally agreed that under existing conditions the Delta is a source of significant mortality for smolts emigrating from upstream areas. This section summarizes available information on the factors contributing to reduced

Table 5.3.4.2-3--Recommended April-June Salmon Smolt Migration Standards (EDF)
(from EDF,23)

| Water Year Type | Annual Survival Index Goal | Sacramento R. | | | San Joaquin R. at Vernalis (cfs) | Total River (Freeport + Vernalis) | Estimated ^{4/} Export + Ch. Depl.- E. Side (cfs) | Estimated Delta Outflow (cfs) |
|-----------------------|-------------------------------------|-----------------------|-------------------|--|--|--|---|--|
| | | Rio Vista (cfs) | Freeport (cfs) | Diversion ^{1/} Above RV (cfs) | | | | |
| Wet | 0.95 | 22,000 | 26,000 | 4,000 ^{2/} | 11,000 | 37,000 | 6,000 | 31,000 |
| Above N. | 0.86 | 20,000 | 24,000 | 4,000 ^{2/} | 10,000 | 34,000 | 7,000 | 27,000 |
| Below N. | 0.75 | 18,000 | 22,000 | 4,000 ^{2/} | 9,000 | 31,000 | 8,000 | 23,000 |
| Dry | 0.65 | 16,000 | 20,000 | 4,000 ^{2/} | 8,000 | 28,000 | 9,000 | 19,000 |
| Critical | 0.30 | 10,000 | 15,000 | 5,000 ^{3/} | 5,000 | 20,000 | 10,000 | 10,000 |

1/ From DWR Exhibit 50

2/ Cross Channel closed, Georgiana Slough only

3/ Cross Channel and Georgiana Slough

4/ Based on recent historic DAYFLOW records

Table 5.3.4.2-4--Recommended Salmon Smolt Protection Levels (BISF)
 (BISF, Brief, 85-86 and 93-98)

| <u>Controlling Year Type</u> | <u>Period</u> | <u>Protection Level (Delta Outflow in cfs)^{1/}</u> | <u>Beneficial Use</u> |
|--|---------------|---|---|
| Wet Years (wettest 10%) | Apr-Jun | 38,500-42,000 | salmon smolts, striped bass, shad |
| Median Years (years between wet and dry) | Apr-Jun | 38,500-42,000 | salmon smolts |
| Dry Years (driest 10%) | Apr-Jun | 10,000 | salmon smolts |

^{1/} Combined Sacramento and San Joaquin River flows to meet outflow

salmon production and hypothetical actions which would eliminate these mortality factors providing optimal protection for the salmon beneficial use in the Delta-Estuary. Much of the recent evidence was based on studies carried out since the 1978 Delta Plan went into effect. These study results were presented in terms of either: (1) correlations between fish survival and flow or other conditions in the Delta; or (2) descriptions of results for which only a few years' data were available and general, not always consistent, trends were apparent.

Evidence has been presented showing that natural populations of Sacramento salmon are declining and San Joaquin populations are undergoing extreme fluctuations. Also, Delta Plan salmon standards are not providing inadequate protection particularly with regard to conditions affecting the fall run smolts during their spring emigration.

Recent studies by the USFWS showed a significant positive correlation between April through June Rio Vista flows and survival of marked hatchery smolts migrating through the Delta (USFWS, 31, 33-41). Several years of data from the San Joaquin Basin suggest a similar relationship (USFWS, 31, 65-71). These studies also indicated a positive relationship between survival and keeping smolts in the main channels of the Sacramento and San Joaquin rivers (USFWS, 31, 72-73; T, XXXVI, 152:6-155:23). Furthermore, survival in both basins may be reduced when spring water temperatures are above the stressful range of 66° to 70°F (T, XXXVI, 159:17-20; DWR, 562, 60; TXXXVI, 150:24-151:11; DFG, 15, 26-27).

The amount of flow is the major determinant of both the quantity and quality of fishery habitat. However, it is not feasible to try to establish or achieve precise numerical fish production goals since many factors, all of which may vary from year to year, influence the number of salmon returning to spawn. Instead, determination is made by fishery biologists as to the general habitat conditions needed to ensure the highest probability of reasonable or optimal fish production levels. This was the approach taken in the Interagency Delta salmon studies carried out by the USFWS. The point was made that correlation does not mean causation (T, XXXVIII, 17:14-16) and that more study is needed before specific actions be taken to change beneficial use protection levels contained in the Delta Plan. However, as the SWC's consultant testified, the likelihood of being able to demonstrate causation when so many of the factors are interrelated (T, XXXVIII, 17:17-24) is difficult (T, XXXVIII, 61:11-17).

In the following sections the factors affecting the salmon beneficial uses are discussed in detail. Recommendations are also made which would theoretically provide optimal protection to the fall run Chinook salmon in the Delta. No evidence regarding specific protection levels needed by smolts of the other three races was submitted, therefore, no discussion of them is presented.

- Problem 1: Decreased spring Delta inflows reduce fall run smolt survival.

DFG testified that the primary factor limiting salmon survival in the Estuary is the survival rate for emigrants (T,XXXVII,66:11-14) and that "there are not substitute measures outside the Estuary that could compensate for all the potential harm that could result from decreased survival within the Estuary" (T,XXXVII,69:4-9).

Since the 1940's upstream and in-Delta facilities have altered seasonal flow patterns. Reservoir operations and water diversions have decreased spring inflows to the Delta (see Figure 5.3.4.3-1).

Historically, the magnitude of spring flow during the fall run smolt emigration period has corresponded to the number of adults returning to spawn about two and one-half years later. In the Sacramento Basin before the improvement in hatchery production in the 1970's, spawning escapement fluctuated in relation to conditions during the smolt emigration period (DWR,561,17-20). An analysis performed by DWR's consultant indicated that prior to 1968, the two year moving average of monthly April-June Sacramento River flows during the smolt emigration period correlated significantly with the two year moving average of subsequent Sacramento Basin spawning escapement (monthly R ranging from 0.53-0.72, $P < 0.01$ or < 0.05 for April, May, and June). April through July Delta outflow also correlated significantly with spawning escapement (monthly R ranging from 0.52-0.77, $P < 0.01$ or 0.05). After 1968 no significant correlation between smolt emigration flows and later adult escapement was found (DWR,561,34-48). Various events occurring after 1967 are thought to have eliminated this relationship, including, closure of the Red Bluff Diversion Dam on the upper Sacramento River (DWR,561,17-20;43-49), "an increase in Delta diversions by initiation of SWP exports, transfer of Trinity River water to the Sacramento Basin, and increased trucking of hatchery production around the Delta" (USFWS,31,77-79).

The practice of trucking and releasing hatchery reared smolts below the Delta has enabled the total adult Sacramento Basin fall run population to be stabilized despite the "persistent decline" of all races of naturally produced salmon and those hatchery reared fish which emigrate down the Sacramento River and through the Delta (T,XXXVII,153:-154:1). As discussed in section 4.5.1.2, survival of fish trucked around the Delta is established to be six to eight times greater than survival of hatchery produced smolts migrating through the Delta (T,XXXVII,161:22-162:1).

Figure 5.3.4.3-1 Change in Delta Inflows from Unimpaired Conditions

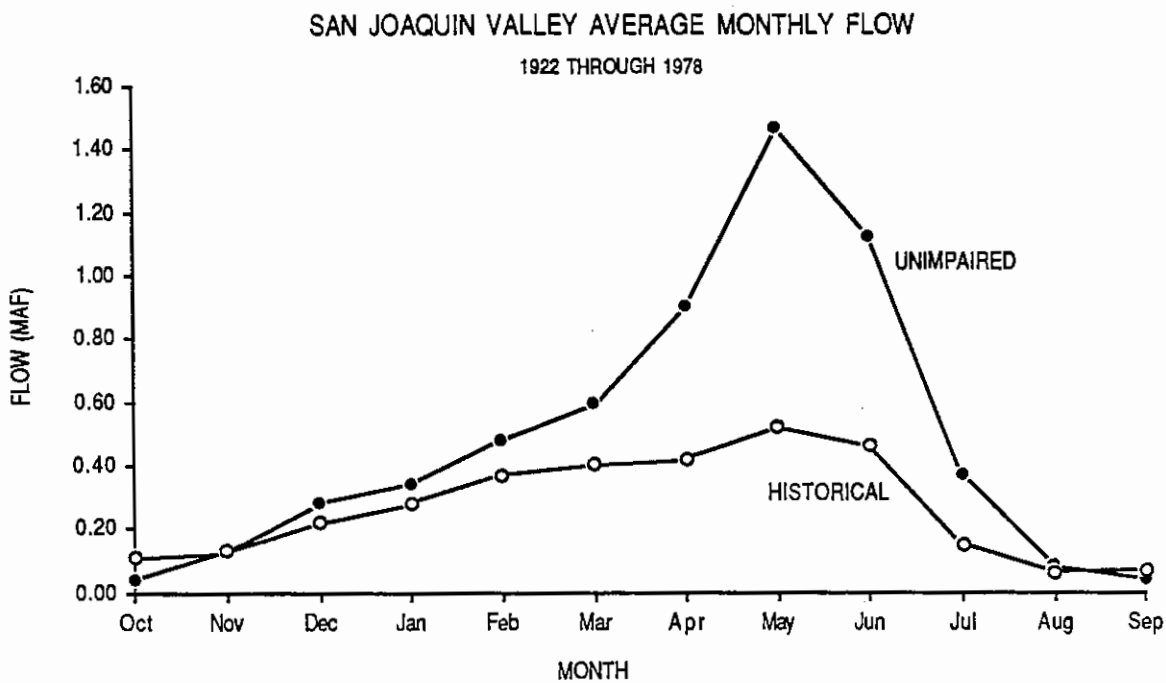
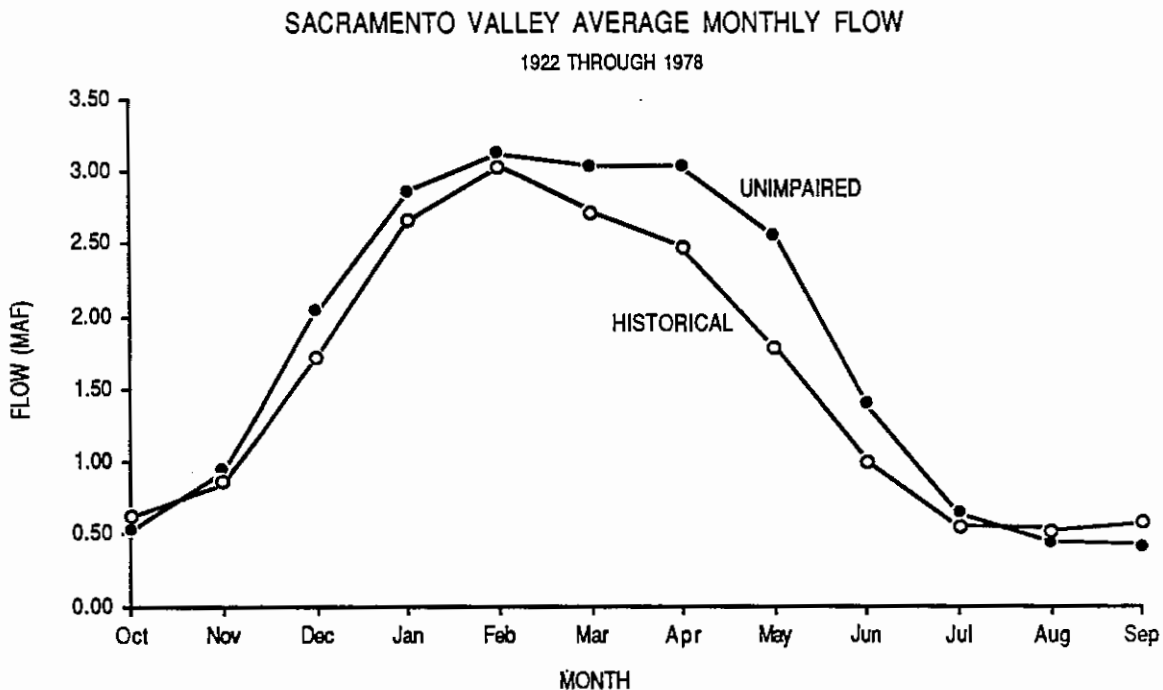

Salmon escapement to the Feather and American rivers has increased, even though reservoir storage has altered spring outflows, because hatchery rearing programs have replaced or augmented natural instream salmon production (DWR, 561, 49). Flows in the lower American River were reported to have no influence on escapement because the run is primarily maintained by planting smolts in the Estuary (DWR, 561, 49). Feather River escapement has continued to be significantly correlated with Sacramento River flows in June ($R=0.75, P<0.01$) and Delta outflow in July ($R=0.74, P<0.01$). Not all Feather River hatchery salmon are released in the Estuary which may account for the continued relationship between Sacramento River flows and escapement to the Feather River. Feather River escapement increases to about 50,000 fish when June flows in the Sacramento River range from about 16,000-25,000 cfs (DWR, 561 40-50) and July Delta outflows range from about 6,000-12,000 cfs (DWR, 561, 41). Feather River escapement appears to have stabilized (DWR, 561, 25) and more escapement fish are produced at lower flows since hatchery production began in 1968 (DWR, 561, 49).

The support provided to the Sacramento Basin salmon fishery by hatchery production has hidden the decline of naturally produced fish migrating down the river (as shown in Figure 4.5.1.2-4). This practice has also counteracted the historical relationship between spring flow conditions and subsequent adult escapement. However, recent USFWS studies of spring inflow to the Delta and smolt survival through the Delta indicate there is still an important relationship between these factors.

USFWS found that Delta smolt survival, as calculated by ocean tag returns of adults marked and released as smolts in the Delta and harvested two to four years later, increases as mean daily flows measured from April through June at Rio Vista increased up to about 22,500 cfs ($R=0.97, P<0.01$) (USFWS, 31, 33-58) (see Figure 5.3.4.3-2). Based on the statistical relationship between Rio Vista flows and smolt survival, USFWS calculated that, under the 1978 Delta Plan salmon flow objectives, the spring smolt survival index would be less than 0.01 (USFWS, 31, 58). In other words, when the regression equation developed from the flow/survival relationship is used with the Delta Plan salmon flows, the resulting amount of salmon smolt expected to survive is less than one percent. The annual abundance of smolts at Chipps Island also increases up to a maximum Rio Vista flow of about 30,000 cfs (USFWS 31, 36-37). Smolt survival was negatively correlated with increasing water temperatures ($R= -0.86, P<0.01$) and percent of Sacramento

FIGURE 5.3.4.3-2 Relationship of smolt survival through the Delta to mean daily Rio Vista flow based on ocean recovery of tagged hatchery smolts. 1/
 (from USFWS, 31, 35)

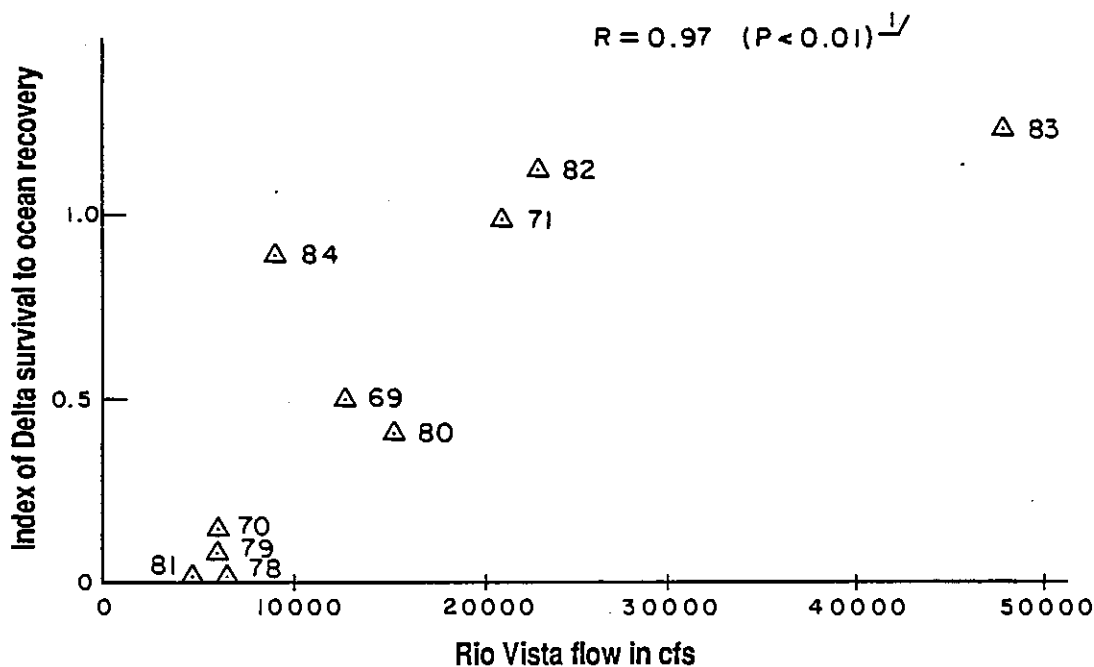

1/ The years 1982-1984 are not included in the regression equation because either fish were released downstream of Sacramento or survival was > 1.0.

2/ Survival = (0.000056 x Rio Vista flow) - 0.258

River flows diverted through the Delta Cross Channel at Walnut Grove during the fall run smolt emigration period of April through June ($R = -0.65, P < 0.05$). Sacramento River flow at Rio Vista was considered to be an index parameter representing the combined interaction of higher Sacramento River flows, lower water temperatures, and a decrease in the relative proportion of Sacramento River flows diverted through the Delta Cross Channel (USFWS, 31, 55; T, XXXVI, 156: 15-23).

These experiments were carried out primarily under 1978 Delta Plan conditions, with normal exports and Cross Channel diversions. As discussed later in this section, these other factors also affect smolt survival.

In addition to calculating monthly survival indices under Delta Plan conditions, USFWS took this index and multiplied it by the percentage of fall run smolts passing Chipps Island in each month (as determined by annual trawl surveys) for 1978-1986 to derive an annual weighted survival index (USFWS, 31, 56-57) (see Table 5.3.4.3-1). As shown in Figure 5.3.4.3-3, annual weighted April through June smolt survival for all 1978-1986 appears to be much better, averaging 0.47, compared to expected survival under the controlling Delta Plan flow objectives which ranges from 0.13-0.24 (see Table 5.3.4.1-3 in section 5.3.4.1). The higher annual weighted survival values, ranging from 0.12-1.0 for any given year, reflect the fact that since 1978 six out of nine years have been wet. As mentioned previously, unregulated Delta flows in April and sometimes in May have been much higher than the controlling flow standards (see Table 5.3.4.1-4).

In order to estimate and compare salmon smolt survival for various historic periods, DWR Dayflow Rio Vista flows values from 1930 to 1987 were used in the USFWS smolt survival/Rio Vista flow equation. Smolt survival indices for mean unimpaired flows for each year type were also compared to the mean historical survivals as shown in Table 5.3.4.3-2. USFWS reported that estimated mean weighted smolt survival using DWRs 1940 level of development hydrology was 0.76 (USFWS, 31e). The smolt survival index values based on selected historic periods indicate a declining trend, from an average of 0.75 under unimpaired conditions to 0.42 since 1968.

Several factors may have contributed some bias in the USFWS studies. Many of the experimental releases of smolts were made in May and June, although emigrating smolts are present throughout April. April conditions are thought to be more favorable to smolt survival (see Figure 5.3.4.3-3) so that the relationship observed between flow and survival may underestimate the mean April through June survival (USFWS, 31, 42-44). Recently planted hatchery fish may not survive as well as wild fish adapted to river conditions.

Table 5.3.4.3-1--Estimated Weighted Survival
Indices Under Delta Plan Conditions^{1/}
(Values in parentheses are the monthly percentage
of smolts migrating past Chipps Island)

| Year | Water Year Type | April ^{2/} Survival Index (%) | May Survival Index (%) | June Survival Index (%) | Annual Estimated Survival Index ^{3/} |
|------|-----------------------|--|------------------------------|-------------------------------|---|
| 1978 | W | 1.0 (27) | 0.69 (40) | 0.07 (33) | 0.57 |
| 1979 | D | 0.40 (19) | 0.30 (52) | 0.05 (29) | 0.25 |
| 1980 | W | 0.74 (14) | 0.40 (34) | 0.33 (52) | 0.41 |
| 1981 | D | 0.43 (34) | 0.17 (50) | 0.0 (16) | 0.23 |
| 1982 | W | 1.0 (18) | 1.0 (49) | 0.80 (33) | 0.93 |
| 1983 | W | 1.0 (19) | 1.0 (49) | 1.0 (32) | 1.0 |
| 1984 | W* | 0.50 (11) | 0.26 (66) | 0.16 (23) | 0.26 |
| 1985 | D | 0.09 (26) | 0.14 (63) | 0.13 (10) | 0.12 |
| 1986 | W | 1.0 (37) | 0.22 (55) | 0.04 (08) | 0.49 |
| Mean | | 0.68 (23) | 0.46 (51) | 0.29 (26) | 0.47 |

* Low spring flows due to subnormal snowmelt

1/ Numbers corrected from values in USFWS, 31,57 Table 4-6,
(P.Brandes pers. comm.)

2/ The monthly survival index is calculated using formula:
 $S = 0.000056 Q - 0.258$; where S=survival and Q=mean monthly
Rio Vista flow in cfs for flows between 4,500 and 22,500 cfs

3/ The weighted annual survival index is the sum of each monthly survival
index times the percentage of smolts migrating past Chipps Island in
that month

FIGURE 5.3.4.3-3 Comparison of mean monthly smolt survival for 1978 Delta Plan controlling flows ^{1/} versus weighted monthly smolt survival based on actual Rio Vista flows and percent smolts passing Chipps Island, 1978 - 1986

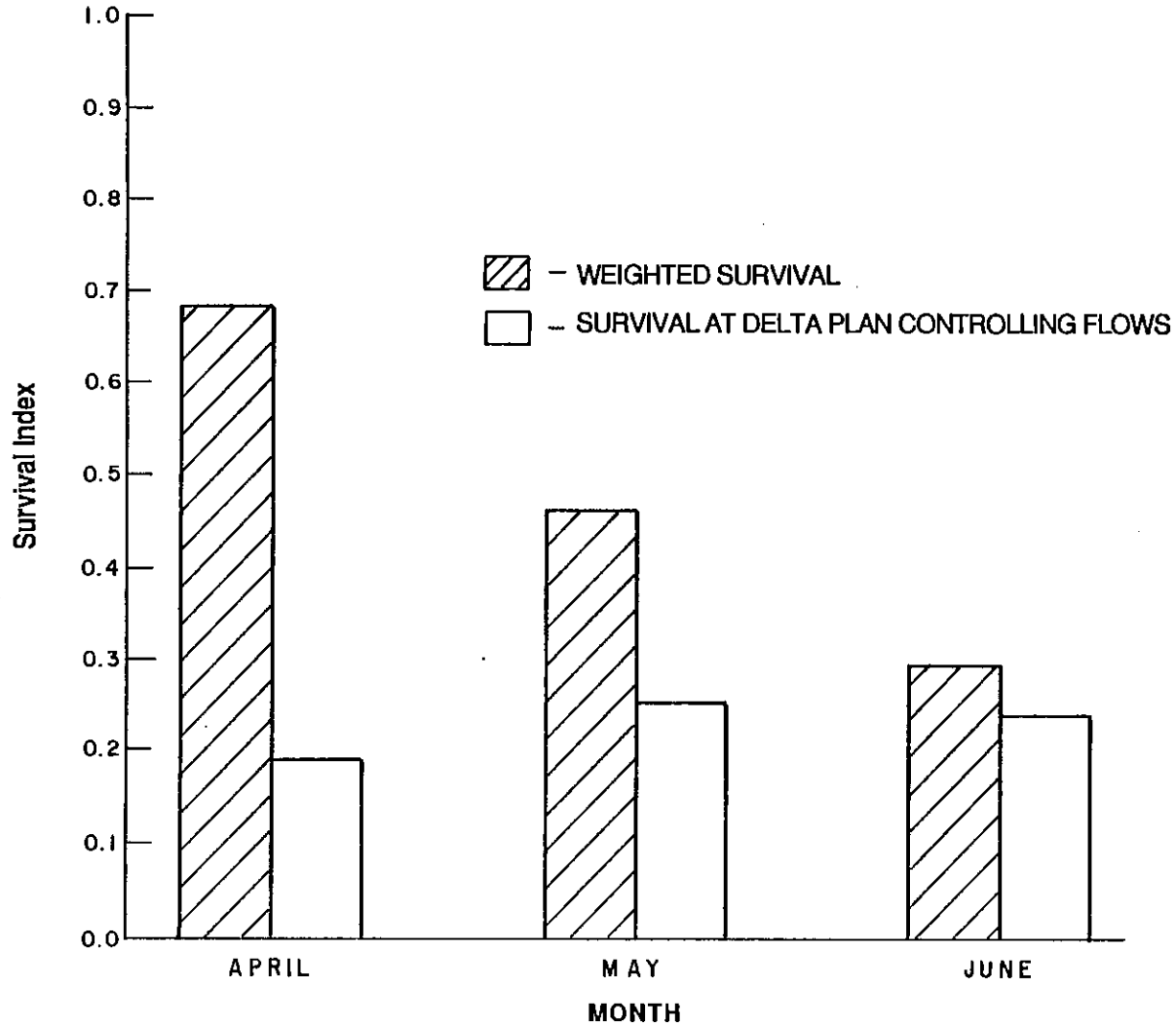

^{1/} Assumes the controlling Delta outflow equivalent occurs upstream at Rio Vista. The upper flow values from Table 5.3.4.1-2 were used so that if the lower flows apply, survival would be reduced from the values shown.

Table 5.3.4.3-2 COMPARISON OF APRIL-JUNE RIO VISTA FLOWS FOR SELECTED HISTORICAL PERIODS 1/ AND CORRESPONDING SMOLT SURVIVAL INDICES

| YEAR TYPE 2/ | APRIL | | MAY | | JUNE | | AVERAGE |
|-------------------------------|----------------|----------|----------------|----------|----------------|----------|--------------|
| | Flow | Survival | Flow | Survival | Flow | Survival | Survival |
| UNIMPAIRED FLOWS 3/ | | | | | | | |
| Wet | 67,308 | 1.00 | 54,248 | 1.00 | 30,468 | 1.00 | 1.00 |
| Above Normal | 51,279 | 1.00 | 33,291 | 1.00 | 16,690 | 0.68 | 0.89 |
| Below Normal | 35,669 | 1.00 | 28,869 | 1.00 | 12,785 | 0.46 | 0.82 |
| Dry | 24,205 | 1.00 | 21,444 | 0.94 | 12,356 | 0.43 | 0.79 |
| Critical | 12,757 | 0.46 | 8,601 | 0.22 | 4,488 | 0.00 | 0.23 |
| Average | 38,244 | 0.89 | 29,291 | 0.83 | 15,357 | 0.51 | 0.75 |
| 1930-1987 FLOWS | | | | | | | |
| Wet | 61,845(22414) | 1.00 | 41,769(22035) | 0.97 | 24,408(18,580) | 0.78 | 0.92 |
| Above Normal | 46,753(22500) | 1.00 | 23,808(20875) | 0.90 | 10,714(10714) | 0.29 | 0.73 |
| Below Normal | 16,933(16333) | 0.66 | 14,672(14554) | 0.56 | 7,563(7563) | 0.17 | 0.46 |
| Dry | 13,205(12673) | 0.45 | 10,818(10203) | 0.31 | 6,619(6619) | 0.12 | 0.30 |
| Critical | 8,749(8749) | 0.26 | 4936(4936) | 0.04 | 2,531(2531) | 0.00 | 0.10 |
| Average 4/ Weighted Avg.5/ | 32,775(17355) | 0.72 | 22,278(15653) | 0.62 | 12,385(10576) | 0.35 | 0.56 0.57 |
| 1953-1987 FLOWS | | | | | | | |
| Wet | 56,542(22371) | 0.99 | 33,327(21,802) | 0.96 | 20,456(17,152) | 0.70 | 0.89 |
| Above Normal | 35,681(22500) | 1.00 | 16,812(16812) | 0.68 | 7,038(7038) | 0.14 | 0.61 |
| Below Normal | 14,178(14163) | 0.54 | 11,558(11381) | 0.38 | 7,331(7331) | 0.16 | 0.36 |
| Dry | 8,177(8177) | 0.20 | 7,027(7027) | 0.14 | 4,841(4841) | 0.03 | 0.12 |
| Critical | 6,690(6690) | 0.16 | 5,165(5165) | 0.05 | 3,715(3715) | 0.00 | 0.07 |
| Average 4/ Weighted Avg.5/ | 27,874(15,401) | 0.61 | 17,685(13,683) | 0.51 | 10,903(9770) | 0.30 | 0.47 0.47 |
| 1930-1952 FLOWS | | | | | | | |
| Wet | 72,452(22500) | 1.00 | 58,653(22500) | 1.00 | 32,313(21436) | 0.94 | 0.98 |
| Above Normal | 51,182(22500) | 1.00 | 26,606(22500) | 1.00 | 12,184(12184) | 0.42 | 0.81 |
| Below Normal | 22,443(20672) | 0.90 | 20,901(20901) | 0.91 | 8,027(8027) | 0.19 | 0.67 |
| Dry | 22,015(20551) | 0.89 | 17,456(15762) | 0.62 | 9,731(9731) | 0.29 | 0.60 |
| Critical | 11,494(11494) | 0.39 | 4,630(4630) | 0.03 | 952(952) | 0.00 | 0.14 |
| Average 4/ Weighted Avg.5/ | 40,234(20328) | 0.88 | 29,268(18650) | 0.79 | 14640(11802) | 0.43 | 0.70 0.70 |
| 1953-1967 FLOWS | | | | | | | |
| ALL | 29,332(16436) | 0.66 | 21,290(15876) | 0.63 | 11,980(10582) | 0.35 | 0.55 |
| 1968-1978 FLOWS | | | | | | | |
| ALL | 24,649(14292) | 0.56 | 13,464(12381) | 0.44 | 8,873(8873) | 0.25 | 0.42 |
| 1979-1987 FLOWS | | | | | | | |
| ALL | 29,387(15031) | 0.58 | 16,835(11619) | 0.39 | 11,588(9513) | 0.28 | 0.42 |

Footnote 1: Flows obtained from DWR DAYFLOW for Rio Vista flows, 1930-1987. 1930-1987 is the period of record. The flow on the left is the actual average flow for all months in that year type. The value in parentheses is the average of the monthly flows with a cap of 22,500 cfs on all individual monthly flows exceeding this value. This is because USFWS data showed that 22,500 cfs produced a maximum survival index of 1.00. It is assumed that flows in excess of 22,500 cfs would not increase smolt survival. 1953-1987 is the period when the major water projects and Delta facilities were in their present configuration. 1930-1952 is the period before the CVP and SWP began major Delta expts. 1953-1967 is the pre-SWP period, 1968-1978 is the pre-Delta Delta Plan period, and 1979-1987 is the post-Delta Plan period. Survival=(Rio Vista Flow)*.000056-.258.

Footnote 2: April-July year type index

Footnote 3: From Flowscience

Footnote 4: Average flow for that month over all year types, not the average of the year type values shown above.

Footnote 5: Weighted survival is the average April-June survival times the number of years of each year type, divided by the total number of years in the historical period.

However, trawl samples of the abundance of unmarked fish at Chipps Island underwent similar numerical changes with changes in flow, temperature, and diversion rate as were observed for marked fish (USFWS,31). Therefore, the survival of the tagged hatchery fish was assumed to be representative of the general effects of certain Delta conditions on all emigrating smolts and accurate enough to be used as an index (USFWS,31,41).

In the San Joaquin Basin, large annual fluctuations in the magnitude of spring flows during the smolt migration are followed by similar fluctuations in adult spawning escapement (T,XXXVI,15:10-23) (see Figure 5.3.4.3-4). The amount of spring flows during the smolt emigration period correlates significantly with subsequent adult escapement two and one half years later ($R=0.82, P<0.01$) (see Figure 5.3.4.3-5). Between 1955 and 1985 when mean April through June flows at Vernalis were around 20,000 cfs or more during smolt emigration, maximum adult escapement of around 40,000 or more fish occurred two and one half years later. Outflows around 5,000 cfs or less were generally associated with subsequent spawning escapement of less than 10,000 fish (USFWS,31,65) (see Figure 5.3.4.3-4). The fluctuating salmon escapement seen in the San Joaquin Basin is probably more typical of the historical response of salmon to varying water supply conditions and the resultant availability of fish habitat with a minimal hatchery contribution; this escapement is similar to what occurred in the Sacramento Basin prior to the increased hatchery contribution of the 1970's (DWR,561,17-20).

Recent USFWS studies of tagged smolts released in the San Joaquin River tributaries in two wet water years when inflows exceeded exports (1982 and 1986), and one critical water year when exports exceeded inflows (1987), showed that the highest survival indices, 0.58 and 0.62, occurred when flows measured at Vernalis were about 8,700 to 12,000 cfs (1982 and 1986). The survival index dropped to 0.17 when Vernalis flows were 2,100 cfs (1987) (USFWS,31,70-71; T,XXXVI,163:11-21) (see Figure 5.3.4.3-6). Based on this limited data, extending a line to intersect the 100 percent survival level suggests that a Vernalis flow of about 20,000 cfs would be needed (see Figure 5.3.4.3-6). DFG estimated that April through early June San Joaquin River inflows to the Delta of about 17,000 cfs would produce 70 percent of historical salmon escapement in the San Joaquin Basin (DFG,15,49). The estimates were based on (1) correlations between spring flows and adult escapement by that year class; and (2) estimates of the channel capacity of a particular river (T,XXXVI,22:17-23:12). Thus, several different evaluations suggest that the greatest salmon smolt survival and/or subsequent adult production occurs when spring flows at Vernalis are around 17,000-20,000 cfs.

FIGURE 5.3.4.3-4 Mean April through June San Joaquin River flows at Vernalis during smolt emigration and subsequent adult escapement 2 1/2 years later. (from USFWS, 31, 66, Figure 4-8)

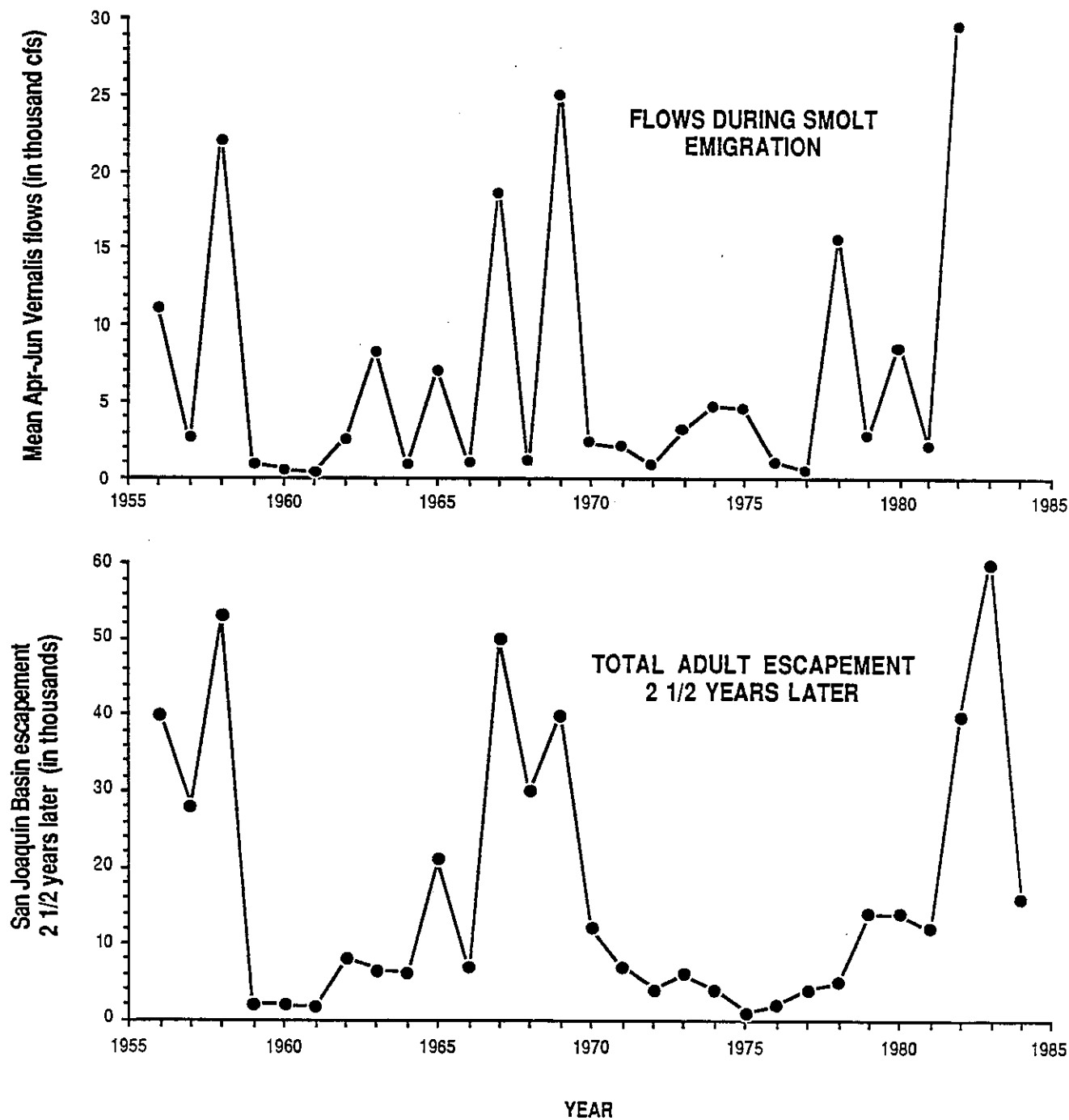

FIGURE 5.3.4.3-5 Relationship between mean April through June flows at Vernalis and adult spawning escapement 2 1/2 years later, 1956-1984 (USFWS, 31, 65)

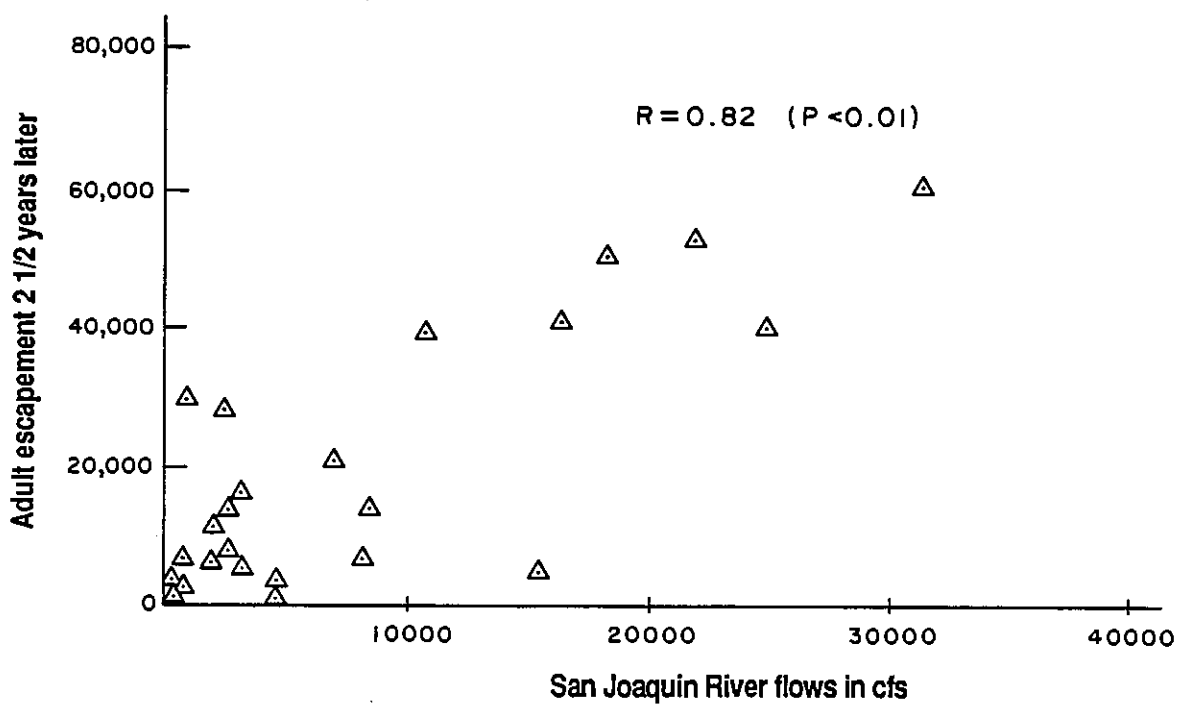
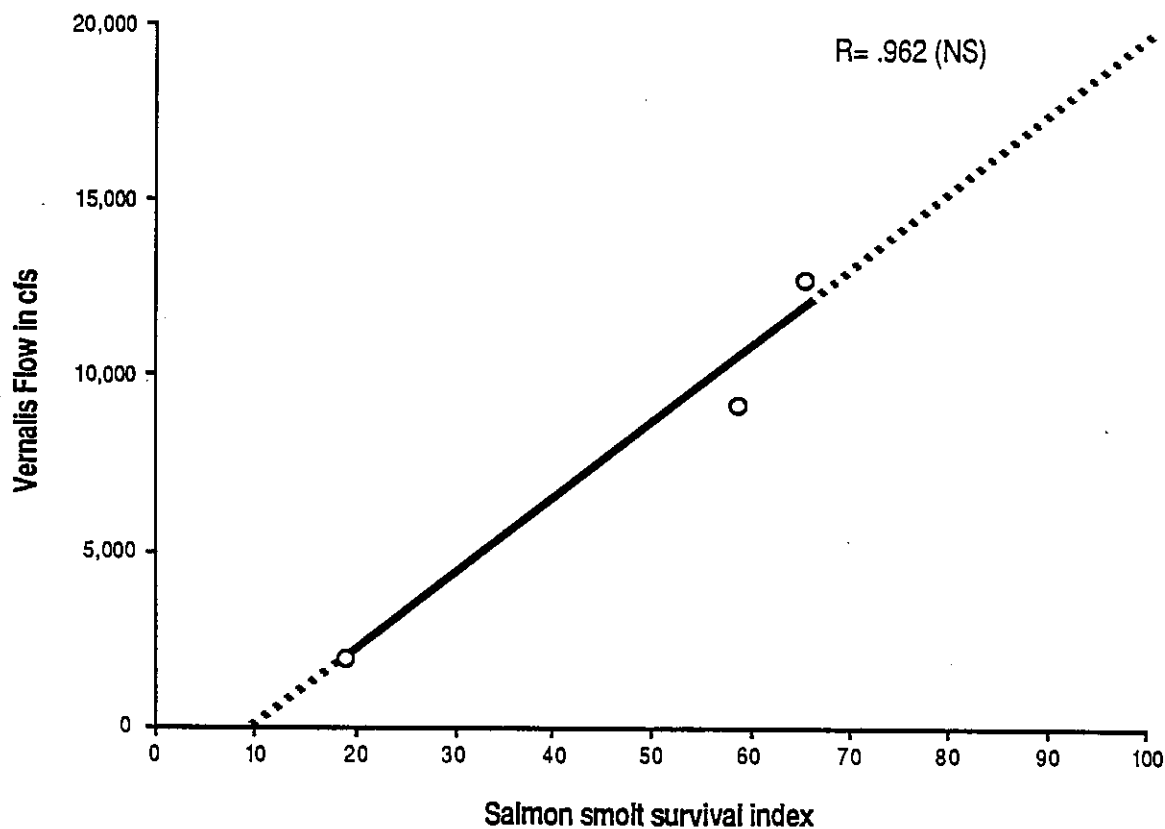

FIGURE 5.3.4.3-6 Mean April to June flows at Vernalis and the corresponding estimated smolt survival index¹ for marked smolt. Projected flows corresponding to maximum adult escapement 2 1/2 years later are shown by the dashed line. (from USFWS, 31,70) (This relationship is shown for informational purposes only since only 3 years of data are available and there is no significant correlation)



¹ Survival = 0.0046 (Mean Apr - Jun Vernalis flow) + 9.733

The optimal protection level described below is based on the flows that would, according to the available evidence, confer optimal habitat protection and facilitate maximum smolt survival without regard to other factors which may also influence Delta smolt survival. Reliance on hatcheries and trucking young fish around conditions shown to cause significant mortality in order to maintain adult production and harvest does not constitute optimal protection of this beneficial use.

- Recommendation: For optimal protection of fall run smolts emigrating down the Sacramento River, the April, May and June mean monthly flows at Rio Vista should be 22,500 cfs.

For the protection of fall run smolts emigrating down the San Joaquin River, the mean April, May and June flow should be 20,000 cfs.

- Problem 2: Diversion of emigrating smolts from historical migration routes reduces their survival.

Tagging studies show that Delta survival decreases when smolts are diverted out of the main channels of the Sacramento and San Joaquin rivers during emigration. Central and southern Delta conditions believed to contribute to reduced smolt survival include: temperatures at stressful, to near lethal, levels during the late spring emigration period; possible poor food supplies; migration delays due to diversion from normal migration routes and reverse flows in Old, Middle, and the lower San Joaquin rivers carrying fish to the CVP and SWP export pumps; high predation rates near the SWP's Clifton Court Forebay; and the fish salvage process at the CVP and SWP export pumps (USFWS, 31, 51-53).

The Delta Cross Channel, which began operating in 1950, splits the Sacramento River flow near Walnut Grove causing more young fish to be diverted into the central and southern Delta than would have passed via Georgianna Slough alone into these areas. Figure 5.3.4.3-7 shows the relationship between Sacramento River flows and flows in the Delta Cross Channel and Georgianna Slough (DWR, 50). Even with the gates closed, a certain amount of Sacramento River flow still moves into the Mokelumne River and the interior Delta via Georgianna Slough (see Figure 5.3.4.1-1). At low flows, a greater proportion of the Sacramento River flow moves through the Cross Channel than at high flows. For example, at Sacramento River flows of 4,000 cfs, about 3,200 cfs or 75 percent is diverted while at flows of 16,000 cfs in the Sacramento River about 6,800 cfs or 42 percent is diverted through the Cross Channel.

FIGURE 5.3.4.3-7 Empirical relationships between flows in Georgiana Slough, Delta Cross Channel and the Sacramento River
 (from DWR,50)

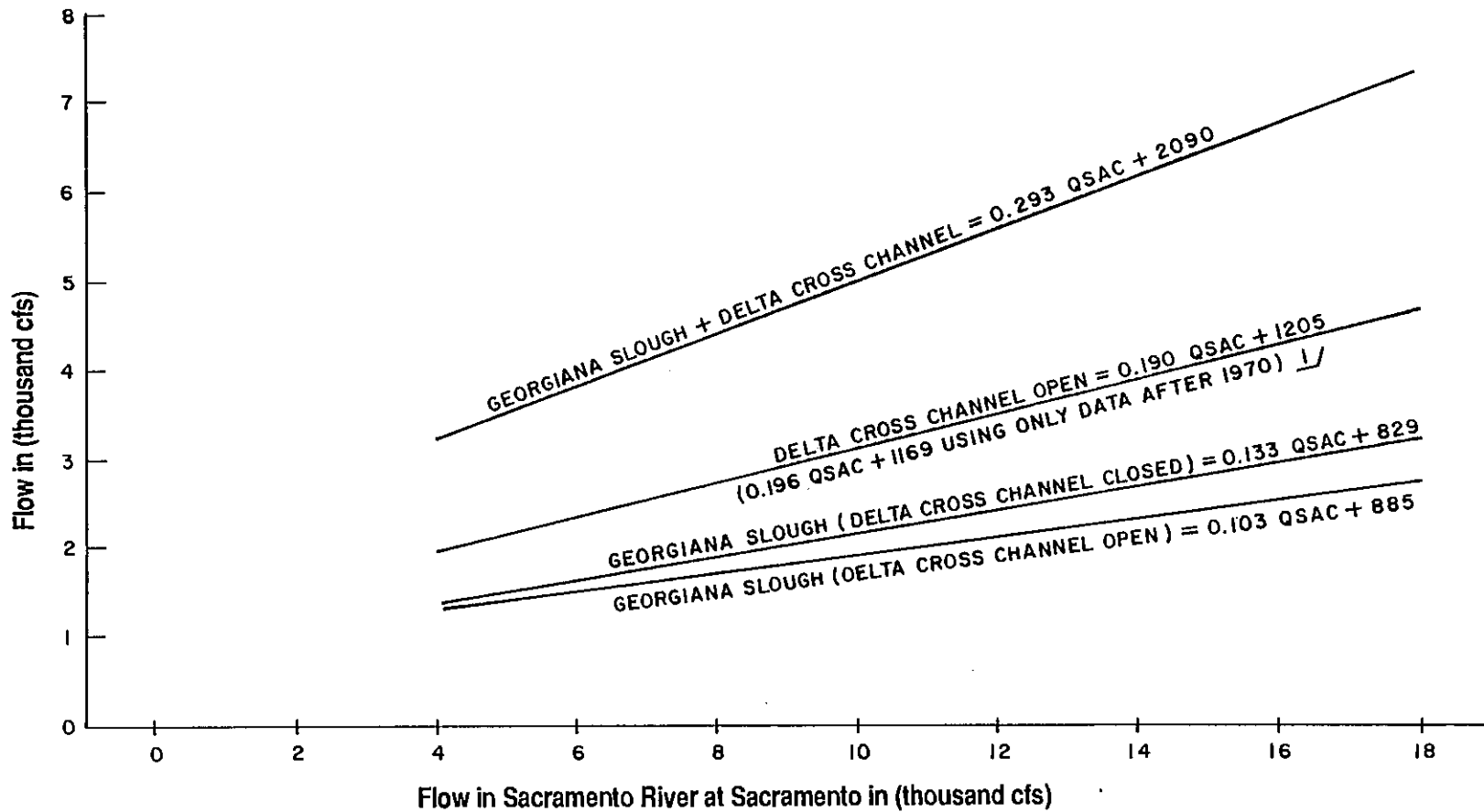

^{1/} Flow split changed slightly after SWP went into operation but the two equations are not significantly different (T,IV, 45: 9-21).

The USFWS reported that one study showed the density of salmon above the Cross Channel to be similar to density in the Cross Channel itself when the gates are open suggesting that fish may be diverted in proportion to the flow split (USFWS,31,44). At lower river flows a greater relative proportion of fish as well as water may therefore be diverted.

If smolts enter the central Delta via Georgiana Slough or the Cross Channel, they can still emigrate successfully by moving down the Mokelumne River and turning west where it joins the San Joaquin River, then following the San Joaquin downstream (see Figure 5.3.4.1-1) (USFWS,31,49). However, smolts migrating to the Bay via the interior Delta travel a longer, more circuitous route and are exposed to increased predation, higher temperatures, and many unscreened agricultural diversions (USFWS,31,44). At the junction of the Mokelumne and San Joaquin rivers they may also encounter reverse flows moving southward toward the SWP and CVP pumping plants (USFWS,31,44-45).

Smolt survival, as measured by ocean tag recoveries, was negatively correlated with the percent of the Sacramento River flow diverted through the Delta Cross Channel ($R=-.65, P<0.05$) flow at Sacramento (USFWS,31,46) (see Figure 5.3.4.3-8). Evaluation of the survival of tagged smolts shows that, with the Cross Channel gates open, smolts released upstream of Walnut Grove survived approximately half as well as smolts released below the Cross Channel in three out of four years (See Table 5.3.4.3-3). Survival of smolts released above the Cross Channel with the gates closed (under low flow conditions and temperatures about 66° F) was about 68 percent greater than with the gates open. When the gates were closed, survival of fish released above the Cross Channel was similar to that of fish released below. Overall, these experiments showed that survival of Sacramento Basin smolts is greatest when they are not diverted into the Delta Cross Channel (T,XXXVI,152:10-155:23).

Studies were also carried out on smolts released at various locations in the central and southern Delta to test the survival of fish diverted from the main river channels via: (1) the Cross Channel; (2) export pumping from Old River; or (3) reverse flows. Although the results of studies in the central Delta are not as clear as those carried out in the Sacramento River, fish released into the central Delta exhibited somewhat lower survival in two out of three years compared to those migrating down the Sacramento River with the Cross Channel closed (T,XXXVI,155:10-17) (see Table 5.3.4.3-3 and Figure 5.3.4.3-8). Overall, survival of smolts released in Old River, where they would be subject to export pumping, was generally lower than the other groups studied except in 1985 (USFWS,31,48-51;T,XXXVI,155:1-23) (see Table 5.3.4.3-3 and Figure 5.3.4.3-9).

FIGURE 5.3.4.3-8 Delta smolt survival (based on ocean tag recoveries of marked salmon) versus percent diverted off the Sacramento River into the Cross Channel and Georgiana Slough at Walnut Grove during the time the marked fish were migrating downstream (USFWS, 31, 46)

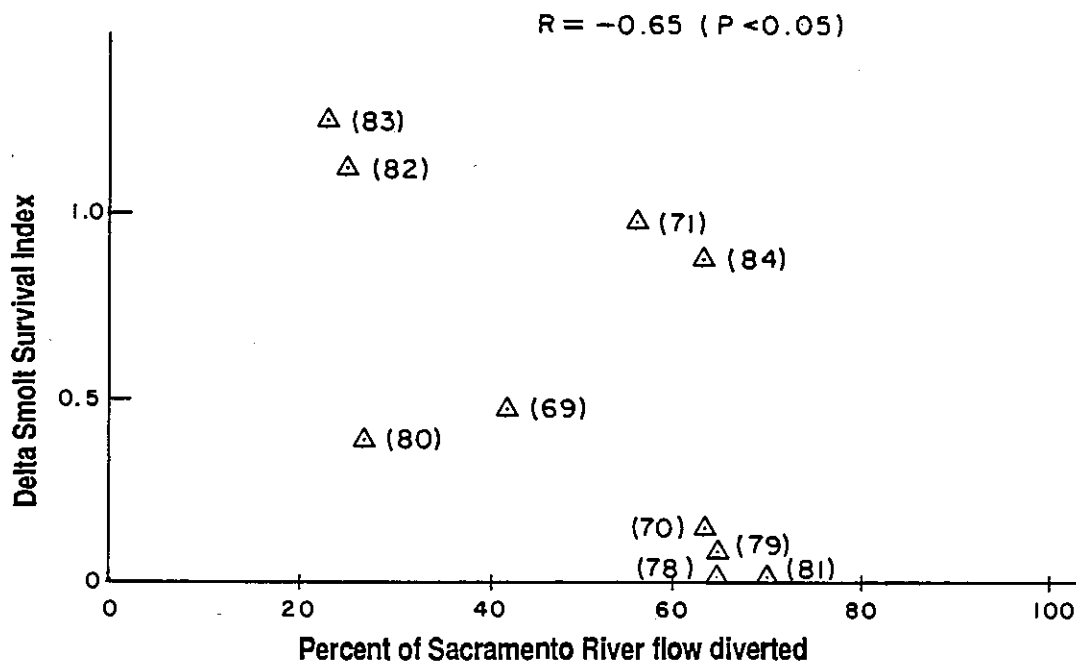

TABLE 5.3.4.3-3 Survival of marked smolts released at different locations in the Delta

| RELEASE LOCATION | Survival Index to Chipps Island | | | | |
|--|---------------------------------|------------------|------------|--------------|-------------|
| | Year | % River Diverted | Gates Open | Gates Closed | Below Gates |
| SACRAMENTO (1) RIVER (Delta Cross Channel) | 1983 | 23 | - | 1.06 (2) | 1.33 (2) |
| | 1984 | 62 | 0.61 | - | 1.05 |
| | 1985 | 65 | 0.34 | - | 0.77 |
| | 1986 | 64 | 0.35 | - | 0.68 |
| | 1987 (0) | 69 | 0.40 | - | 0.88 |
| | 1987 (c) | 29 | - | 0.67 | 0.85 |
| | Mean = | | 0.42 | 0.83 | 0.86 |

| | Survival Index to Chipps Island | | | |
|--|---------------------------------|------------|------------|-------|
| | Year | North Fork | South Fork | Lower |
| CENTRAL DELTA (1) (Mokelumne River) | 1983 | - | - | 1.13 |
| | 1984 | 0.51 | 0.86 | - |
| | 1985 | 0.28 | 0.23 | - |
| | 1986 | 0.36 | 0.26 | - |
| | Mean = | 0.38 | 0.45 | |

| | Survival Index to Chipps Island | | | |
|----------------|---------------------------------|------------------------|------------------------|---------------------------------------|
| | Year | Lower (1) Old River | Upper (3) Old River | San Joaquin R. (3) below Old River |
| SOUTHERN DELTA | 1982 | - | - | 0.60 |
| | 1983 | 0.33 | - | - |
| | 1984 | 0.16 | - | - |
| | 1985 | 0.21 | 0.62 | 0.59 |
| | 1986 | 0.23 | 0.20 | 0.34 |
| | 1987 | - | 0.16 | 0.82 |
| | Mean = | 0.23 | 0.33 | 0.59 |

(1) from USFWS, 31, 48, Table 4-2

(2) values >1.0 suggest some sampling error and were reduced to 1.0 when calculating the mean

(3) from USFWS, 31, 70, Table 4-9

FIGURE 5.3.4.3-9 Mean Survival of tagged smolts released at different locations and recovered at Chipps Island
 (after USFWS, 31, Tables 4-2 and 4-9)

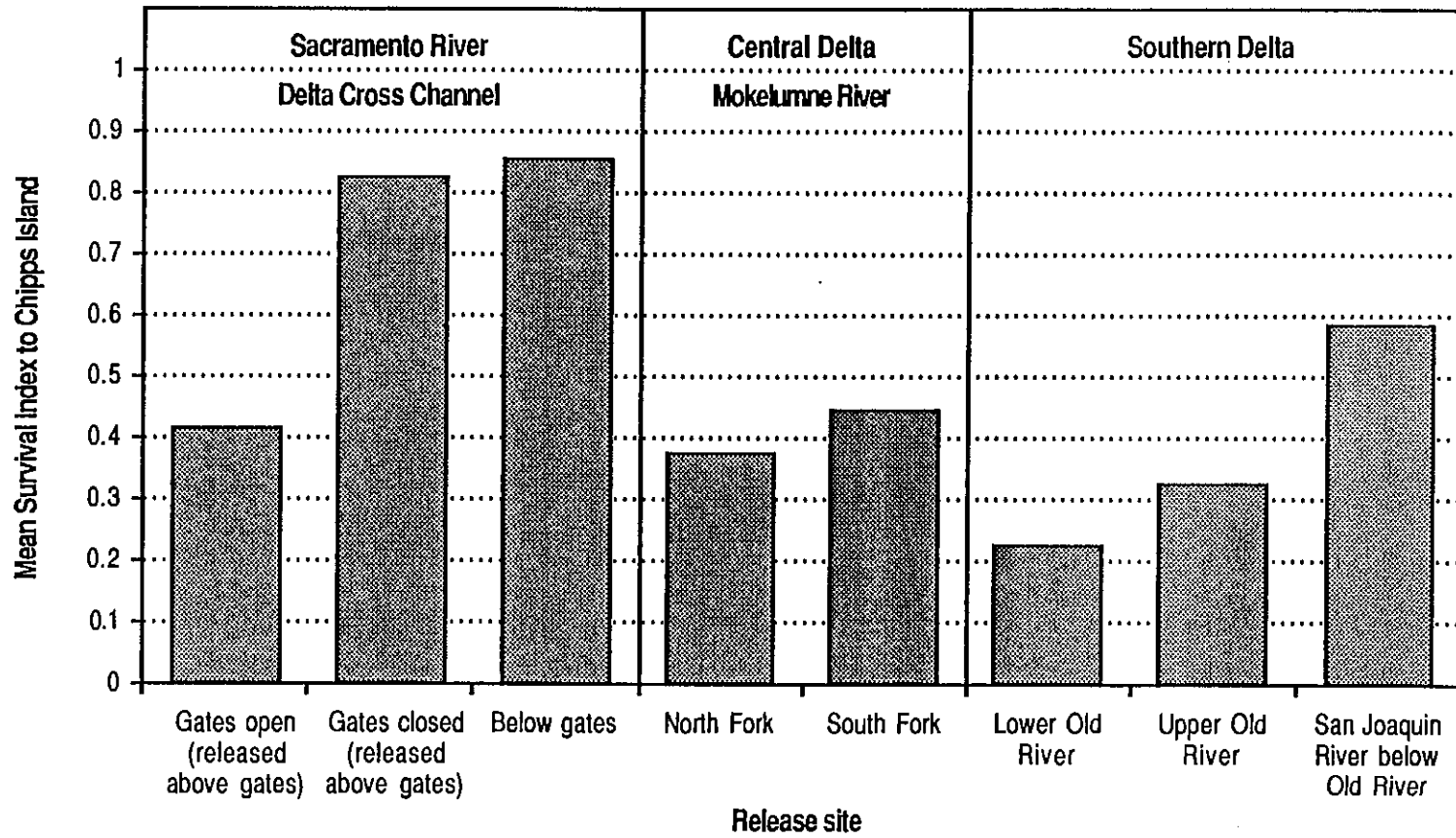

Export pumping is a factor believed to contribute to reduced smolt survival (USFWS,31,44-51). As discussed in Section 5.3.4.1, export pumping in the spring frequently diverts the entire San Joaquin River inflow via Old River and can also reverse flows in the lower reaches of the San Joaquin, Old and Middle rivers downstream of the pumps. Even when most of the San Joaquin River inflows were exported from Old River, smolts generally survived better if they remained in the main channel of the San Joaquin River (T,XXXVI,165:17-23). To test this, groups of smolts were released in the San Joaquin River below its junction with Old River and in upper Old River enroute to the export pumps. Fish released in the San Joaquin River downstream of its junction with Old River had, on average, higher survival rates compared to smolts released in Old River (T,XXXVI,165:7-23) where they would be carried towards the export pumps (see Table 5.3.4.3-3 and Figure 5.3.4.3-9). Of smolts released in upper Old River (upstream of the export pumps) in 1985, 1986 and 1987, 25 percent, 74 percent and 27 percent, respectively, turned up at the pumping plant fish protective facilities compared to 3 percent, 3 percent and 8 percent of smolts released in the San Joaquin River below its junction with Old River (T,XXXVIII,47:10-15;USFWS,31,70). However, recovery of experimental smolts at Chipps Island is highest when smolts remain in the main channels of the Sacramento and San Joaquin Rivers (USFWS,3,45-49; Id.,74). Tagging studies show that, even though all flows may be diverted through the pumping plants, some smolts are able to find their way to Chipps Island (T,XXXVII,47:10-48:4).

Fry also rear in the Delta and, as was mentioned in Section 5.3.4.1, the 1978 Delta Plan provides for closure of the Cross Channel gates when Sacramento River flows exceed 12,000 cfs between January 1 and April 15. Fry are mostly present in the Delta from about January through April (T,XXXVI,169:8-10), with the highest abundance in the Delta in February or March (USFWS,31,82).As inflows to the Delta increase so do the number of fry.Also, their distribution extends further downstream, sometimes as far as San Francisco Bay (T,XXXVI,169:13-18). In wet years USFWS reported that fry survival in the central Delta was no different than that in the north Delta, but in dry years it was lower (USFWS,31,88). Ocean tag recoveries indicate that survival of fry in the northern Delta is better than that of fry released in the central Delta. Survival of Delta fry is better than that of fry released in San Francisco Bay (T,XXXVI,169:21-170:4). This evidence suggests that fry survival is improved if they are kept out of the central Delta in drier years but that their location in the Delta makes little difference in wet years; furthermore, fry carried into the Bay by very high flows may not survive well.

- Recommendations: Diversion of smolt or fry from their historical migration route or nursery areas can reduce survival. For optimal protection of fry rearing in the Delta, the Cross Channel gates should remain closed between January and April under below normal, dry, and critical water year conditions. For optimal protection of fall run smolt emigration, the Cross Channel gates should remain closed from April 1 through June 30.
- Problem 3: CVP and SWP export pumping from the Delta decreases salmon survival.

USFWS presented evidence, described in the previous section, suggesting that smolts subjected to reverse flows associated with export pumping do not survive as well as smolts which are not. Flows in the lower San Joaquin, Old and Middle river typically reverse when Delta exports exceed Vernalis inflows. In the 20 years, from 1968 to 1987, the mean April through June exports exceeded mean Vernalis inflows 15 times (see Figure 5.3.4.3-10). TID/MID's model of factors affecting salmon production also suggests that increasing spring Delta exports contribute significantly to decreases in the magnitude of subsequent adult escapement to the San Joaquin Basin (TID/MID,2,1-4). In addition to diverting emigrating smolts from their normal migration routes, there are direct losses of fish at the Delta pumping plants which increase with increasing export rates (see Figure 5.3.4.3-11)

Salmon losses and salvage values are influenced by the timing, abundance and distribution of salmon in the Estuary, hydrologic conditions and project operations (DFG,17,28; T,XXXVII,35:11-15;T,XXXVII,124:5-22). DFG testified that losses reflect the amount of water going through the pumping plants when fish are present in the Delta (T,XXXVII,38:9-14). Monthly fish losses and salvage are highest during April through June and lowest during July through September (see Figure 4.5.1.2-3) (DFG,17,Appendix Table 4). There are year to year shifts in the peak of emigration through the Delta due to factors upstream of the Delta. In general, San Joaquin Basin smolts migrate somewhat earlier than Sacramento Basin smolts. Many Sacramento River Basin hatchery smolts released upstream of the Delta reach the Delta in June. Tagging studies show that Sacramento Basin smolts are mostly entrained at the SWP facilities while San Joaquin Basin smolts show up at the CVP fish screens (USFWS,31,53-55). The CVP exports averaged about 2,000-3,000 cfs from the Delta during the spring in the 1950's (see Figure 5.3.4.3-10). The SWP began exporting from the Delta in 1968, and, under the 1978 Delta Plan, combined CVP and SWP exports during the spring smolt migration period have increased to around 6,000 cfs (see Figure 5.3.4.3-10). While average salmon losses associated with CVP exports have remained similar since 1968, average losses associated with SWP operations have more than tripled since the 1978 Delta Plan became effective (see Table 5.3.4.3-4).

FIGURE 5.3.4.3-10 Comparison of mean April - June Delta exports and inflows at Vernalis, 1956 - 1987 (from DWR, Dayflow)

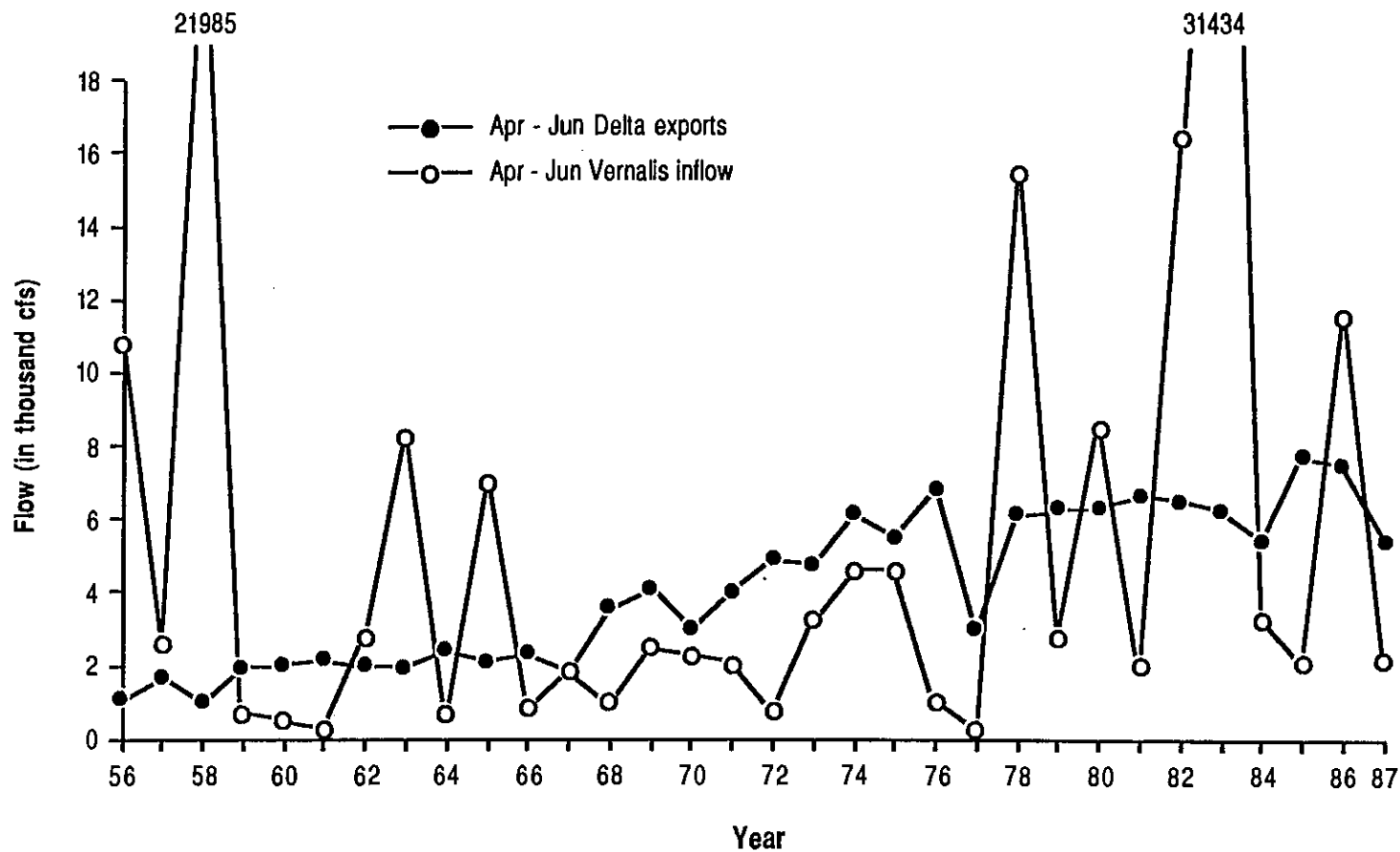

5-62

FIGURE 5.3.4.3-11 Change in mean monthly annual Delta exports and estimated Chinook salmon losses, 1956 - 1986
(from DWR, Dayflow, and DFG, 17)

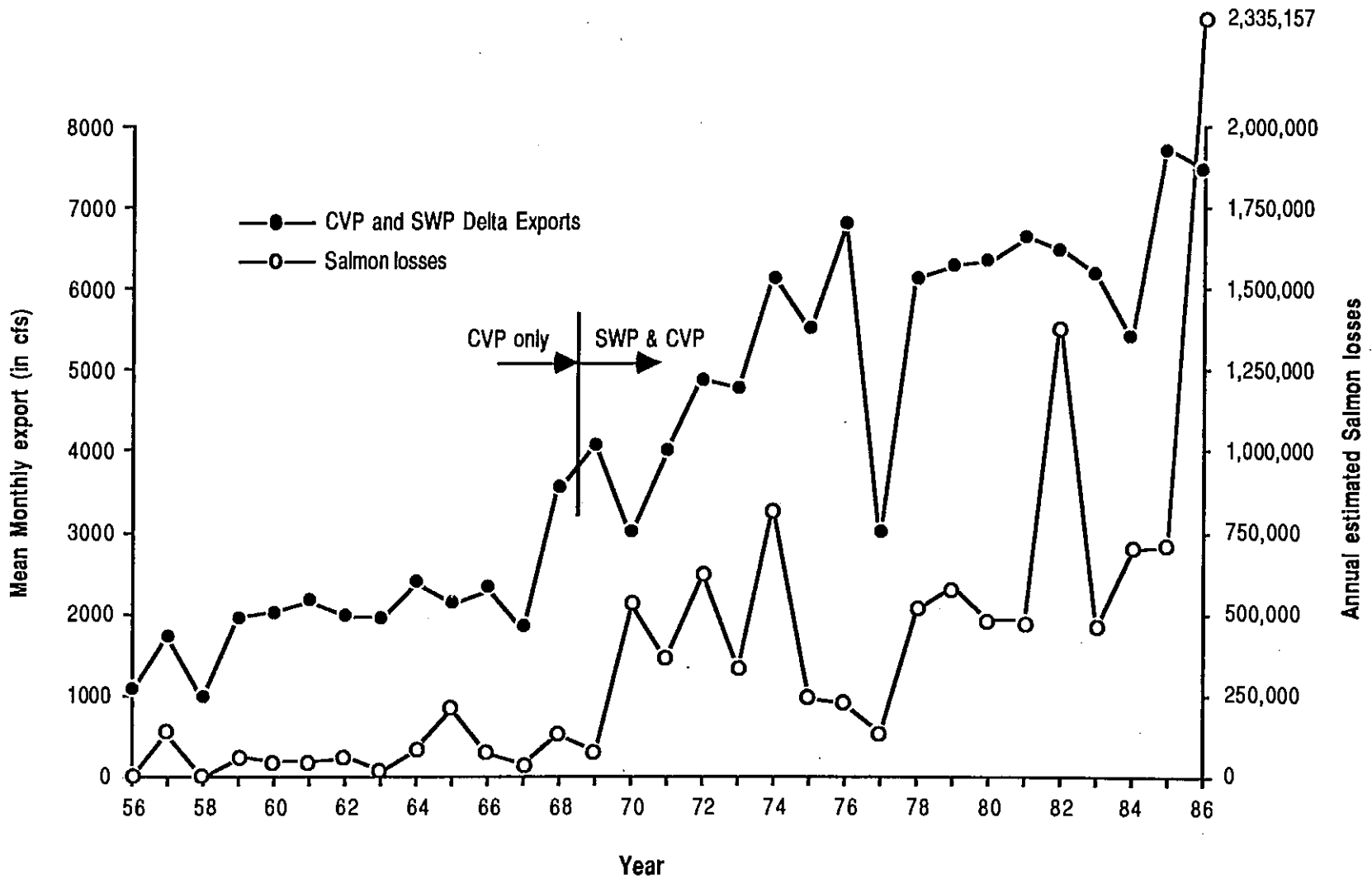

Table 5.3.4.3-4--Comparison of Mean Annual Estimated
Chinook Salmon Losses and Monthly Exports
at the CVP and SWP Fish Protection Facilities
1957-1986 (from DFG,17) and Mean Annual
Exports in cfs (DWR,Dayflow)

| Period ^{1/} | <u>CVP</u> | | <u>SWP</u> | | <u>Total</u> | |
|----------------------|---------------------------------|---------------------------|---------------------------------|---------------------------|-------------------------|--------------------------|
| | Mean Annual Salmon Losses | Mean Annual Exports | Mean Annual Salmon Losses | Mean Annual Exports | Mean Total Losses | Mean Total Exports |
| 1957-1967 | 68,886 | 1,843 | 0 | 0 | 68,886 | 1,843 |
| 1968-1977 | 136,865 | 2,865 | 108,540 | 1,592 | 345,405 | 4,446 |
| 1978-1986 | 129,442 | 3,314 | 719,275 | 3,133 | 848,717 | 6,447 |

^{1/}Begins 1957 when fish losses calculated. Contra Costa Water District exports not included in total

The much higher losses at the SWP's Harvey O. Banks Delta Pumping Plant compared to the CVP's Tracy Pumping Plant may be related to several factors. Forebay conditions, including the presence of predators, contribute to this situation (DFG, 17, 16; DWR, 560, 2-3; DWR, 560-6). Predation losses for salmon in Clifton Court average 75 percent (DFG, 17, 17). Prescreening mortality for salmon was estimated to average 75 percent at the SWP facilities as compared to 15 percent at the CVP facilities (DFG, 17, 14; T, XXXVII, 38:4-8; T, XXXVII, 35:22-36:8). The large increase in losses at the SWP facilities suggest that as exports of water from the Sacramento River Basin, which produces many more salmon, have increased so has the quantity of fish entrained. The USFWS testified that fish salvage operational criteria in D-1485 may provide some protection for fish at the CVP and SWP pumping plants (T, XXXVI, 166:20-21). However, according to DFG, these criteria preclude the flexibility needed to alter operations in response to yearly shifts in the timing of peak fish abundance (T, XXXVII, 134:1-19).

DFG and DWR entered into an agreement, which became effective in 1986, for a program to offset losses of salmon, steelhead, and striped bass at the Harvey O. Banks Delta Pumping Plant (DWR, 569, 1). According to the agreement, habitat restoration and other non-hatchery measures are to be given priority, and special emphasis is to be given to the San Joaquin River system for salmon habitat (DWR, 560, 6). No specific plans to reduce fish losses in Clifton Court forebay are contained in this agreement (DWR, 560, 9).

- Recommendation: Salmon survival is reduced during export of water from the Delta by the CVP and SWP. For optimal protection of fall run smolts, no water should be exported from the Delta by the CVP and SWP between April 1 and June 30.
- Problem 4: Water temperatures during the spring smolt emigration period reach levels that cause stress to fish.

Water temperature is another factor identified as affecting smolt survival in the Delta (see section 4.5.1.2). DWR's consultant testified that since 1978, temperatures at Sacramento have been two to three degrees centigrade (about four to six degrees Fahrenheit) higher (T, XXXVII, 157:11-15). Consequently, smolts emigrating later in the season are likely to suffer higher mortalities (T, XXXVII, 226:15-20). Sacramento Basin smolts would be affected, particularly hatchery reared fish which are released late in the spring, because the peak of emigration occurs somewhat later than in the San Joaquin Basin (T, XXXVII, 215:17-22; T, XXXVII, 225:23-226:7; DFG, 15, 17-23; USFWS, 31, 23). USFWS found that based on ocean tag recoveries, smolt survival decreased as water temperatures increased ($R=-0.86$ $P<0.01$) (see Figure 5.3.4. 3-12). On the other hand, the survival index exceeded 50

FIGURE 5.3.4.3-12 Relationship between mean water temperatures and survival of marked smolts between Sacramento and Suisun Bay (based on ocean recoveries) (from USFWS, 31, 43)

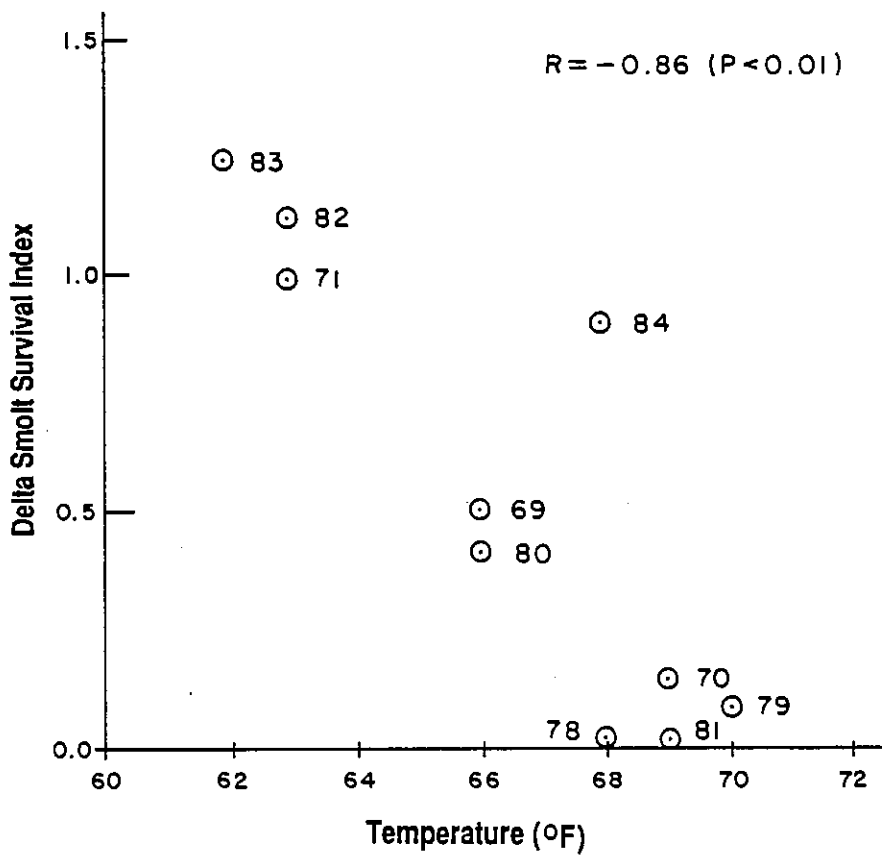

percent when Sacramento River temperature at Freeport was 66°F or less (USFWS, 31, 43). Although temperature generally decreases as flow increases, there is a large temperature range at any given flow (T, XXXVII, 157:4-8). In May, Sacramento River temperatures (at Freeport) are typically less than 66°F at flows between 25,000-30,000 cfs. San Joaquin River temperatures are generally less than 66°F at Vernalis flows of 5,000 cfs or more (DWR, 562, 54; USFWS, 31, 148; DFG, 15, 26). When Sacramento River flows are below 20,000 cfs in June, the 5 day mean water temperature exceeds 66°F about half the time (T, XXXVII, 156:24-157:2). By June temperatures do not drop below 66°F unless flows are about 30,000-40,000 cfs at Freeport (DWR, 562, 55; USFWS, 31, 148).

Laboratory studies have shown that a smolt's tolerance of elevated temperatures is improved when food supply is optimal (DWR, 563, 1-3). DWR's consultants testified that DFG's records indicate that the abundance of Neomysis, one of the primary foods of emigrating salmon (T, XXXVII, 207:23-25), has decreased significantly in the last 20 years (T, XXXVII, 207:25-208:1) and that upstream and estuarine food supplies may be poor. Taken together, these conditions could aggravate the effects of higher temperatures during emigration (T, XXXVII, 207:3-9).

- Recommendation: The recommended flows for optimal protection of fall run smolts should significantly decrease May and June water temperatures in the Sacramento and San Joaquin rivers.
- Problem 5: Water quality conditions may block upstream migration in the San Joaquin River.

Within the Estuary, upstream migration of adult Chinook salmon occurs year round. The largest numbers of adult salmon are present in the Estuary from July through November (T, XXXVI, 171:1-5) with the fall run predominating during much of this period. The fall run, which migrates upstream from July through November, is the only race in the San Joaquin Basin, while the late-fall, winter and spring runs migrate to spawning grounds in the upper Sacramento Basin from October to August (see Figure 4.5.1.2-1). As discussed in Section 4.5.1.2, adults follow olfactory cues contained in downstream flows of water from their homestream. The 1978 Delta Plan contained specific monthly Rio Vista flows for salmon migration ranging from 1,000 to 5,000 cfs (see Table 5.3.4.1-1). No minimum flows of homestream water have been identified for successful upstream migration, though it has been reported that salmon were able to migrate up the San Joaquin River when flows past Stockton were as low as 500 cfs (1978 Delta Plan draft EIR, p.III-80). It has been found that temperatures of about 65°F and DO levels below 5 mg/l in the fall have sometimes partially blocked adult migration in the San Joaquin River near Stockton (USFWS, 31, 94).

To address this problem in the San Joaquin River, an agreement was reached in 1969 among the USBR, DWR, and DFG (an agreement still in effect although not incorporated into the 1978 Delta Plan conditions) under which DWR monitors DO levels in the San Joaquin River between Stockton and Turner Cut (Stockton Ship Channel) during the fall migration. If DO drops below 6 mg/l, a temporary rock barrier is installed across the head of Old River to increase San Joaquin River flows past Stockton thus improving DO levels (T,XXXVII,85:4-22). Better treatment of cannery wastes since 1978 (reducing the biochemical oxygen demand) and improved flows and water quality from New Melones Reservoir operations were reported to have helped alleviate this problem (USFWS,31,94). Since then, the Old River barrier has been installed in the fall of 1979, 1981, 1984 and 1987 (H. Proctor,DWR,pers.comm).

- Recommendation: For the protection of adult Chinook salmon migration in the Estuary, there should be downstream flows in the Sacramento River equal to or greater than those required under the 1978 Delta Plan for salmon migration. Minimum flows in the San Joaquin River past Stockton should be 500 cfs from July through November for protection of fall run upstream migration. DO should not fall below 6 mg/l in the San Joaquin River between Stockton and Turner Cut during these months.

The theoretical objectives which would provide optimal protection for salmon in the Estuary are summarized in Table 5.3.4.3-5.

5.3.5 Striped Bass

5.3.5.1 No Action Alternative:

Striped bass are included specifically in the beneficial uses protected under the Delta Plan (Table VI-1, pp. VI-31-33,35). Included are specific electrical conductivity and flow standards as well as certain operational constraints required of the SWP and CVP. These standards evolved out of negotiations conducted among DFG, DWR, USFWS, and USBR prior to the Delta Plan hearing as part of a draft Four-Agency agreement; this agreement was never implemented (DFG,25,133). These standards have not accomplished the intended goal of maintaining the actual Striped Bass Index (SBI) at a long-term average of 79 (the so called "Without Project" conditions). Based on a mathematical relationship (predicted SBI; see below) developed by DFG, the actual SBI under the Delta Plan (1979-1985) should have averaged about 65 (corrected from DFG,25,134-136 after consultation with DFG staff). In fact, during those years (excluding 1986, in which the index reached predicted levels), the actual SBI averaged 22.4, about one third of the predicted SBI (corrected from DFG,25,136). In 1988, the actual SBI reached an all-time low of 4.6.

Table 5.3.4.3-5--Optimal Levels of Protection for Salmon

| <u>Time Period</u> | <u>Location</u> | <u>Objective/Action</u> | <u>Use Protected</u> |
|------------------------|---|---|--------------------------------------|
| July 1- November 30 | San Joaquin River between Stockton and Turner Cut | Maintain DO \geq 6 mg/l | Adult Migration (fall run) |
| July 1- November 30 | San Joaquin River at Stockton | 500 cfs flow | (fall run) |
| All Year | Sacramento River | flows \geq Delta Plan | (all runs) |
| January-1 April-30 | Delta Cross Channel | Close gates under below normal, dry, and critical water years | Fry Rearing (fall run) |
| April-1 June-30 | Delta Cross Channel | Close gates | Smolt Emigration (fall run) |
| April-1 June-30 | Sacramento R. at Rio Vista | 22,500 cfs flow | Smolt Emigration (fall run) |
| April-1 June-30 | San Joaquin R. at Vernalis | 20,00 cfs flow | Smolt Emigration (fall run) |
| April- June-30 | Delta pumping plants | No exports | Emigration/ Rearing (fall run) |

The actual SBI is a value obtained after extensive field sampling and measuring of larval striped bass each summer. This value is a measure of the relative abundance of young striped bass in the Estuary when their average length is 38 mm (1.5 inches). It is called an index because it is a relative value and is not directly translatable into an absolute value of the number of larvae in the Estuary. However, it is a legitimate and relatively sensitive measure of the change in abundance of larvae between years. The actual SBI tends to underestimate the larval abundance in very high outflow years (such as 1983) because many of the larvae are carried downstream beyond the DFG sampling stations. The actual SBI has been measured every year since 1959, except 1966.

The actual SBI is not the only measurement of striped bass populations. A variety of sampling programs are employed in monitoring various components of the striped bass population (Table 5.3.5.1-1). While the decline rates and patterns may vary somewhat, all programs measuring striped bass abundance show large declines from the levels measured in the 1960's (DFG, 25, 6:25, 9).

Table 5.3.5.1-1--Methods to Assess Population
Levels of Striped Bass

ADULTS

1. Petersen Estimate--Mark and recapture method; 1969 to present; in Delta and Sacramento River; statistical analysis of number of fish recaptured which were marked in previous years.
2. Catch Per Unit Effort (CPUE) Index--Index of population based on number of fish caught per standardized unit of time; same locations as for Petersen estimate; 1969 to present except 1977, 1978, and 1981; possibly more reliable than Petersen estimate (DFG,25,Appendix 1).
3. Tag Returns--1958 to present, except 1962-1964 and 1967-1968; analysis of tags returned by fisherman; provides basis for comparison of fishing vs. "natural" mortality.
4. Party Boat Census--Annual reports submitted by party boat operators; provides information on numbers of fish caught, number of angler-days, and related information.
5. Creel Census--Informal surveys of shorelines, piers and private boats to examine catch rates, fish sizes and other information for other than party boat operations; done sporadically, with reduced effort in recent years.

EGGS, LARVAE AND JUVENILES

1. Petersen Fecundity Estimate--Annual since 1977; combines Petersen population estimate with fecundity (egg number) data from Striped Bass Health Monitoring Program, with certain correction factors (age and number of fish spawning) to estimate total number of eggs produced.
2. CPUE Fecundity Index--Uses same procedure as above except that uses catch per unit effort (CPUE) index value for number of spawning females rather than Petersen estimate.
3. Egg and Larva Survey--Area sampled variable but standardized in recent years to Suisun Bay, central and western Delta, and Sacramento River to Colusa; 1966-1973, 1975, 1977, 1984-1986; intensive sampling at 75 stations in spring to monitor number, growth, movement and mortality of larvae up to about 14 mm in length; Sacramento River stations also monitor egg abundance and movement.
4. Tow Net Survey--1959 to present except 1966; Delta and Suisun Bay; biweekly sampling at 30-40 stations in summer until average length of larvae exceeds 38 mm length; provides index of abundance (actual Striped Bass Index, or SBI) and distributional information.
5. Midwater Trawl--Throughout Bay-Delta Estuary up to Rio Vista and Clifton Court Forebay; 1967 to present except 1974 and 1979; typically monthly tows between September and December at a variable number of stations; gives measure of young-of-the-year abundance; more variable than SBI.

Table 5.3.5.1-1 (Continued)

RELATED SURVEYS

1. Salvage Records--Provides numbers of fish salvaged from Skinner Fish Protective Facility in Clifton Court Forebay; annual from about 1970 to present; provides general estimate of population trends and densities based on number salvaged over time.
2. Striped Bass Health Monitoring Program--1978 to present, not all years; 1984 to present under consistent format; analysis of tissues of 40 prespawning adult female fish from Rio Vista and Antioch; provides samples for fecundity data.
3. Other--Various other special purpose studies which provide special information on striped bass (Export Curtailment Study, gut content analysis, spring die-off monitoring, etc.).

There has been considerable confusion in the testimony concerning whether the SBI in the Delta Plan has "worked" or "failed." This is because the Delta Plan set standards based on a predicted SBI, a mathematical formula based on the relationship of the historical record of larval abundance (actual SBI) to spring Delta outflow and exports. This formula provided a prediction of what the SBI ought to be, given certain flow and export conditions, and it was used to develop the export and outflow standards in the Delta Plan. The discrepancy between the actual and the predicted SBI is the reason that some participants stated that "the SBI has failed". However, the actual SBI has not failed. It continues to provide a comparative measure among years. In fact, the actual SBI simply reflects the fact that the Delta Plan standards have been inadequate to maintain striped bass at 1975 levels, much less restore them to "without project" levels.

The actual SBI is the sum of two separate indices: The Suisun Bay index and the Delta index (Table 5.3.5.1-2). Throughout the 1960's, the Delta index has been the major contributor to the overall actual SBI (Figure 5.3.5.1-1). Generally in the 1970's and 1980's the actual SBI declined, in large part because of the decline in the Delta index (Figure 5.3.5.1-2). As shown in Table 5.3.5.1-2, during the period 1959-1970 (except 1966) the Delta index was greater than 60 percent of the total actual SBI in five of eleven years, and was less than 40 percent of the total actual SBI in only one year (1967). By contrast, during the 18-year period 1971-1988, during which a significant increase in Delta exports had occurred (see section 5.3.5.3), the Delta index was greater than 60 percent of the total actual SBI in only two years (1977 and 1988, both critically dry years with very low outflow and low SBI's), and was less than 40 percent of the total actual SBI in 12 of 18 years. For the ten-year period in which the Delta Plan standards were in effect (1979-1988), the Delta index was greater than 60 percent of the total actual SBI only in 1988, and was less than 40 percent in seven of the ten years. These results indicate a substantial shift in the survival patterns of striped bass larvae in recent years. The probable reasons for this shift are discussed in Section 5.3.5.3.

5.3.5.2 Advocated Levels of Protection

The extensive testimony and exhibits presented on striped bass emphasize the point that, despite years of study, there is no consensus on the causes of the striped bass decline. As a result, two main and highly divergent approaches to the problem evolved during Phase I of the hearing. These approaches may be summarized as follows:

TABLE 5.3.5.1-2 STRIPED BASS INDEX DATA

| YEAR | YEAR | DATE | JULIAN | DELTA | SUISUN | TOTAL | 5-YEAR | DELTA % | PRED. | ACTUAL % | |
|------|----------|----------|----------------|-------|--------|----------------|---------|----------|----------------|----------|-------|
| YEAR | TYPE (1) | TYPE (2) | DATE | INDEX | INDEX | INDEX | RUNNING | OF TOTAL | INDEX | OF PRED. | |
| | | | | | | | AVERAGE | | | | |
| 1959 | D | D | JULY 12 | 193 | 30.7 | 3.0 | 33.7 | - | 91.1 | 34.1 | 98.8 |
| 1960 | BH-SNSM | D | JULY 17 | 199 | 32.0 | 13.6 | 45.6 | - | 70.2 | 55.1 | 82.8 |
| 1961 | D | D | JULY 21 | 202 | 25.2 | 6.4 | 31.6 | - | 79.7 | 45.5 | 69.5 |
| 1962 | BN | BN | JULY 26 | 207 | 46.8 | 32.1 | 78.9 | - | 59.3 | 79.1 | 99.7 |
| 1963 | W | W | AUG 03 | 215 | 38.2 | 43.5 | 81.7 | 54.3 | 46.8 | 87.3 | 93.6 |
| 1964 | D | D | AUG 02 | 215 | 54.7 | 20.7 | 75.4 | 62.6 | 72.5 | 63.3 | 119.1 |
| 1965 | W | W | JULY 31 | 212 | 49.4 | 67.8 | 117.2 | 77.0 | 42.2 | 87.7 | 133.6 |
| 1966 | BN-SNSM | BN | NOT DETERMINED | | | NOT DETERMINED | | | NOT DETERMINED | | |
| 1967 | W | W | AUG 12 | 224 | 35.1 | 73.6 | 108.7 | 95.8 | 32.3 | 92.7 | 117.3 |
| 1968 | BN-SNSM | D | JULY 19 | 201 | 39.6 | 17.7 | 57.3 | 89.7 | 69.1 | 44.5 | 128.8 |
| 1969 | W | W | AUG 09 | 221 | 33.6 | 40.2 | 73.8 | 89.3 | 45.5 | 92.7 | 79.6 |
| 1970 | W-SNSM | D | JULY 18 | 199 | 36.6 | 41.9 | 78.5 | 79.6 | 46.6 | 66.8 | 117.5 |
| 1971 | W | W | AUG 11 | 223 | 24.6 | 45.0 | 69.6 | 77.6 | 35.3 | 83.4 | 83.5 |
| 1972 | BN-SNSM | BN | JULY 25 | 207 | 13.4 | 21.1 | 34.5 | 62.7 | 38.8 | 33.7 | 102.4 |
| 1973 | W | BN | JULY 15 | 196 | 15.6 | 47.1 | 62.7 | 63.8 | 24.9 | 53.8 | 116.5 |
| 1974 | W | W | JULY 22 | 203 | 17.4 | 63.4 | 80.8 | 65.2 | 21.5 | 63.1 | 128.1 |
| 1975 | AN | W | JULY 30 | 211 | 23.4 | 42.1 | 65.5 | 62.6 | 35.7 | 83.8 | 78.2 |
| 1976 | C | C | JULY 16 | 198 | 21.1 | 14.8 | 35.9 | 55.9 | 58.8 | 45.6 | 78.7 |
| 1977 | C | C | JULY 24 | 205 | 8.3 | 0.7 | 9.0 | 50.8 | 92.2 | 47.5 | 18.9 |
| 1978 | W | AN | JULY 23 | 204 | 16.5 | 13.1 | 29.6 | 44.2 | 55.7 | 65.1 | 45.5 |
| 1979 | D | BN | JULY 19 | 200 | 5.4 | 11.5 | 16.9 | 31.4 | 32.0 | 54.9 | 30.8 |
| 1980 | W | BN | JULY 15 | 197 | 2.8 | 11.2 | 14.0 | 21.1 | 20.0 | 80.5 | 17.4 |
| 1981 | D | C | JULY 02 | 183 | 15.4 | 13.7 | 29.1 | 19.7 | 52.9 | 58.0 | 50.2 |
| 1982 | W | W | JULY 30 | 211 | 9.5 | 39.2 | 48.7 | 27.7 | 19.5 | 79.3 | 61.4 |
| 1983 | W | W | AUG 05 | 217 | 1.2 | 14.2 | 15.4 | 24.8 | 7.8 | 78.3 | 19.7 |
| 1984 | W-SNSM | BN | JULY 13 | 195 | 6.3 | 20.0 | 26.3 | 26.7 | 24.0 | 68.6 | 38.3 |
| 1985 | D | D | JULY 16 | 197 | 2.2 | 4.1 | 6.3 | 25.2 | 34.9 | 34.1 | 18.5 |
| 1986 | W-SNSM | BN | JULY 09 | 190 | 23.8 | 41.1 | 64.9 | 32.3 | 36.7 | 65.1 | 99.7 |
| 1987 | C | C | JUNE 22 | 173 | 7.3 | 5.3 | 12.6 | 25.1 | 57.9 | 43.5 | 29.0 |
| 1988 | C | C | JULY 24 | 206 | 3.9 | 0.7 | 4.6 | 22.9 | 84.8 | N.D. | N.D. |

NOTES:

1. WATER YEAR TYPE (1) = BASED ON 1978 DELTA PLAN STANDARDS
2. WATER YEAR TYPE (2) = BASED ON PROPOSED SACRAMENTO VALLEY APRIL - JULY FORMAT
3. WATER YEAR TYPE CODE: W=WET; AN=ABOVE NORMAL; BN=BELOW NORMAL;
D=DRY; C=CRITICAL; SNSM=SUBNORMAL SNOWMELT
4. 5 YEAR RUNNING AVERAGE INCLUDES 4 YEARS ONLY FOR 1967 - 1970
5. N.D. = NOT DETERMINED

FIGURE 5.3.5.1-1 STRIPED BASS INDEX

(NO SAMPLE IN 1966)

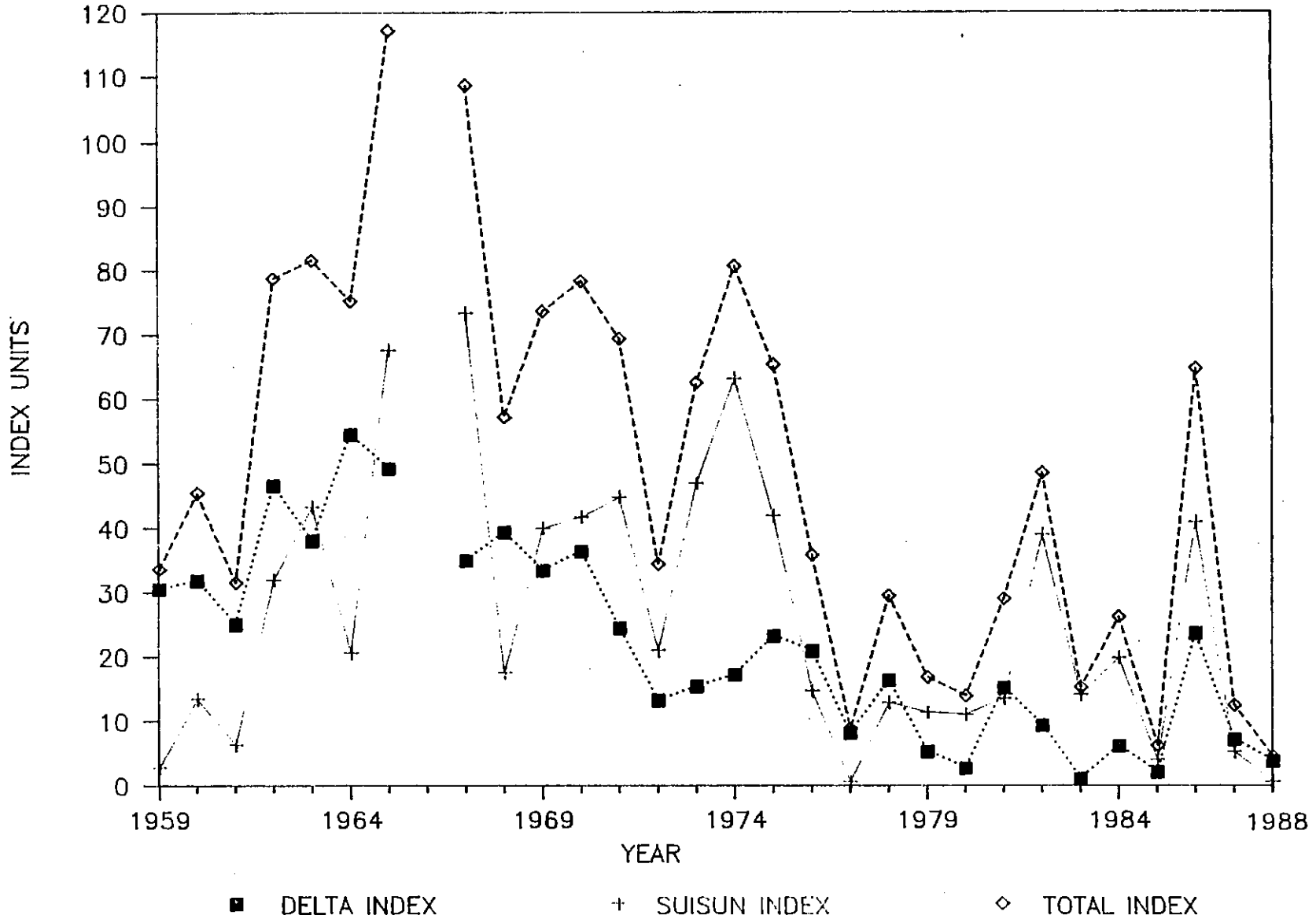

5-75

FIGURE 5.3.5.1-2 DELTA STRIPED BASS INDEX

AS PER CENT OF TOTAL ACTUAL STRIPED BASS INDEX

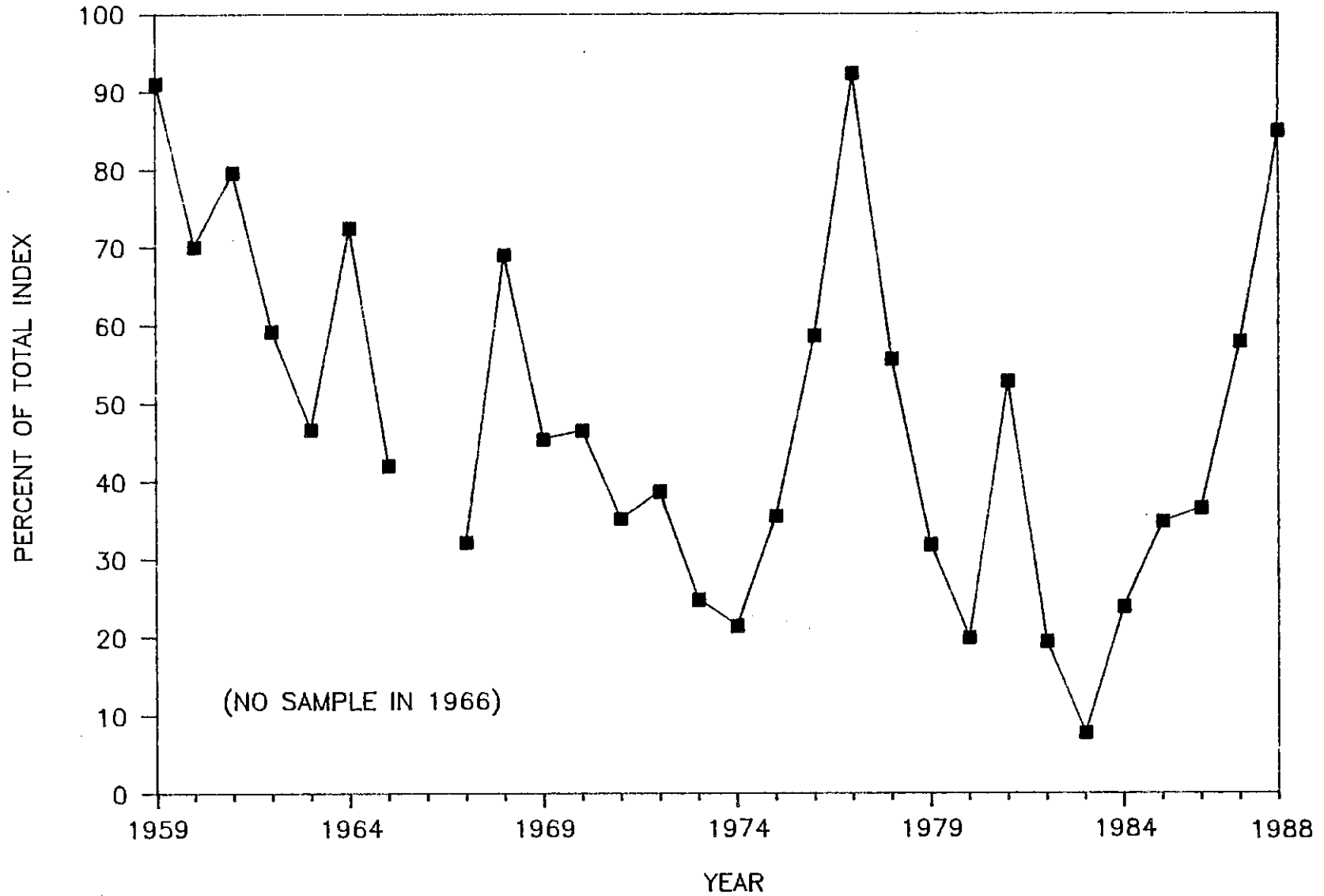

5-76

- Retain Present Standards

Because there is no agreement on what to do about striped bass, it was suggested that the present Delta Plan standards be retained for the most part until "cause and effect" relationships have been determined. This position was advocated by SWC, DWR, and others (SWC, 203, 4; DWR, 602, 2). SWC proposed five major hypotheses for the possible decline of striped bass (SWC, 203, 22). Four of these involve the effects of water export either directly or indirectly. The SWC, among others, advocate an extensive series of experiments to test these various hypotheses; but in the meantime, the current standards should be retained except to facilitate performing these tests. This approach is discussed further in Section 5.3.5.3.

- Change the Delta Plan Standards to Attempt to Provide Additional Protection

This position was advocated by DFG, USFWS, EDF and others. The main argument here is that striped bass are not being protected by the Delta Plan standards, and the population is in serious decline. Therefore, something must be done now, even if all the reasons for the decline are not known; enough is known to at least proceed in some areas.

The major proposal for changed objectives was put forth by DFG (DFG, 64, 6-12) with support from USFWS in their own recommendations (USFWS, 47, 5-6). Both agencies called for short-term measures, primarily in the form of greatly increased outflow and changes in the operation of the Delta Cross Channel gates. Long-term proposals included recommendations for eliminating reverse flows in the San Joaquin River by 1995, examination of new Delta water transfer facilities, possible operational changes, and evaluation of current research and monitoring programs required by the Delta Plan (DFG, 64, 14-19).

The overall goal of DFG was to achieve an annual production of young striped bass equal to a long-term average actual SBI of 106, which they determined was the "historical level" (DFG, 64, 6). DFG believes this is not a realistic objective in the near future (DFG, 64, 6) and cannot be achieved with their present state of knowledge about striped bass (T, LX, 102:24-103:16). In fact, DFG estimated that their increased flow recommendations and other changes would, on average, increase the SBI only to 28, which is six points, i.e., 25 percent, higher than the average of the 1979-1985 period (T, LX, 102:3-21). The proposed flow objectives do not call for increased flow beyond the levels presently required under the Delta Plan for critical years, or for dry years following dry or critical years (DFG, 64, 6; T, LX, 82:2-4). No changes in exports are proposed except that a limit of 5,000 cfs total diversions would be imposed in May and June, rather than the present 6,000 cfs, when water is being withdrawn from storage for export (DFG, 25, 7; T, LX, 82:11-15).

A larger percentage of total Delta inflow is exported under low flow conditions in the Delta; this provision would somewhat reduce impacts on striped bass larvae. DFG also proposed expansion of the provision for closure of the Delta Cross Channel gates to include the ability to request closures when the Delta Outflow Index is less than 12,000 cfs. Under the Delta Plan, DFG can request closure of the gates only when the Delta Outflow Index is greater than 12,000 cfs. DFG did not recommend any change in the length of the period during which such requests can be made (April 16--May 31 in all years). All other Delta Plan standards would remain in effect (DFG,25,7).

USFWS proposed flow objectives and operational changes similar to DFG as short-term measures, as well as similar long-term recommendations, such as elimination of reverse flows in the lower San Joaquin River (USFWS,47,5-6). However, they also proposed that outflow be not less than 10,000 cfs during the May through July period "to keep larvae and young-of-the-year [striped bass] in Suisun Bay and maintain the null zone (spring-summer) no further [upstream] than Honker Bay" (USFWS,47,5). This contradicts their own recommendation in support of the Delta Plan flow standards, per DFG, for critical years, and dry years following dry or critical years. No testimony was presented to resolve this contradiction.

EDF also proposed increased outflow standards (EDF,25). The recommendations are similar to, and are based on DFG recommendations, but include a multiplier factor of 1.5 in May, 1.0 in June, and 0.7 in July to the recommended May-June flow increases to adjust for the greater densities of eggs and larvae which are present in the earlier months (T,LVII,78:21-79:4). The recommended flow levels were expected to provide survival approaching "without project" levels. However, it was EDF's opinion that protection at "historic levels" would require higher levels than those recommended; EDF did not determine what those flow levels might be (T,LVII,79:5-18). In some years, the recommended flows would actually be greater than unimpaired flows (T,LVII,80:7-81:5).

5.3.5.3 Optimal Levels of Protection

The striped bass problem in the Estuary is very complicated, and there probably is no single answer to the problem. However, important steps could be taken to protect striped bass that are not being employed at present. Therefore, the recommendation by some participants that the present Delta Plan standards remain in effect is rejected. The striped bass population has declined too much (perhaps in excess of 70 percent since the 1950's) to take no definitive actions to provide additional protection. None of the participants disputed the fact that there is a problem with striped bass, even if they differed on what course to take. The record low 1988 SBI of 4.6 further emphasizes the need to take immediate action.

Changes in the Delta Plan are appropriate standards because they are not doing what they were intended to do i.e., provide reasonable protection for striped bass. This beneficial use is not being protected to the extent originally intended by the Board in the Delta Plan; therefore, steps must be taken to provide additional protection. Certain steps have been suggested which are not related to flow and salinity standards, or which are intended to provide "equivalent protection" for striped bass. In general, these proposed actions do not provide equivalent protection or are not relevant to actions included under this Plan. These alternative measures will be discussed in individual sections below as appropriate.

In rejecting continuation of the current Delta Plan standards, it is important to understand why those standards did not work. Spring flow and export standards have not worked because they were being applied to a situation in the Delta which was significantly different from the one under which the data used to develop the formulas for the predictive index were obtained. The original relationship among the predictive SBI, outflows and exports was based on data developed during the period 1959-1970. During this period, exports in the spring were primarily from the CVP, and certain major upstream storage projects (Oroville and New Melones) had not been completed or had not yet had a significant effect on the Delta. As shown in Figure 5.3.5.3-1, total Delta exports (SWP, CVP, and CCC) were relatively constant at about 3,500 cfs during the April through July period. However, during the 1971 through 1976 period, when the decline in the Delta portion of the SBI began to become apparent, total exports for the April through July period increased to an average of 6,000 cfs. When Delta Plan standards for striped bass were in effect (1979-1988), the average April through July total exports were about 6,300 cfs, or 80 percent higher than for the 1959-1970 period, and 45 percent higher than the 1959-1976 period (the period used for development of the predicted SBI in the Delta Plan).

The relationship for the May through July periods, on which the Delta Plan standards were set, shows a similar pattern. Average May through July total Delta exports for the period 1959-1970 were about 3,700 cfs. During the period 1971-1976, the average exports increased to 6,300 cfs. For the period that the Delta Plan standards were in effect (1979-1988), average May-July exports declined slightly from the 1971-1976 period to about 6,200 cfs, due to the export restrictions imposed by the Delta Plan. This restriction represents less than three percent reduction from the 1971-1976 period, when the Delta index was declining. In effect, the Delta Plan standards stabilized exports at post-1970 levels, but did nothing to provide protection comparable to that found under the original relationship from the 1959-1970 period. Under the Delta Plan, average total Delta exports in the months of May, June, and July are still 66 percent higher than the 1959-1970 period, and 34 percent higher than the 1959-1976 period (the period used as the basis for the predictive index).

FIGURE 5.3.5.3-1 TOTAL DELTA EXPORTS

COMBINED SWP, CVP, AND CCC; APRIL - JULY AVERAGE

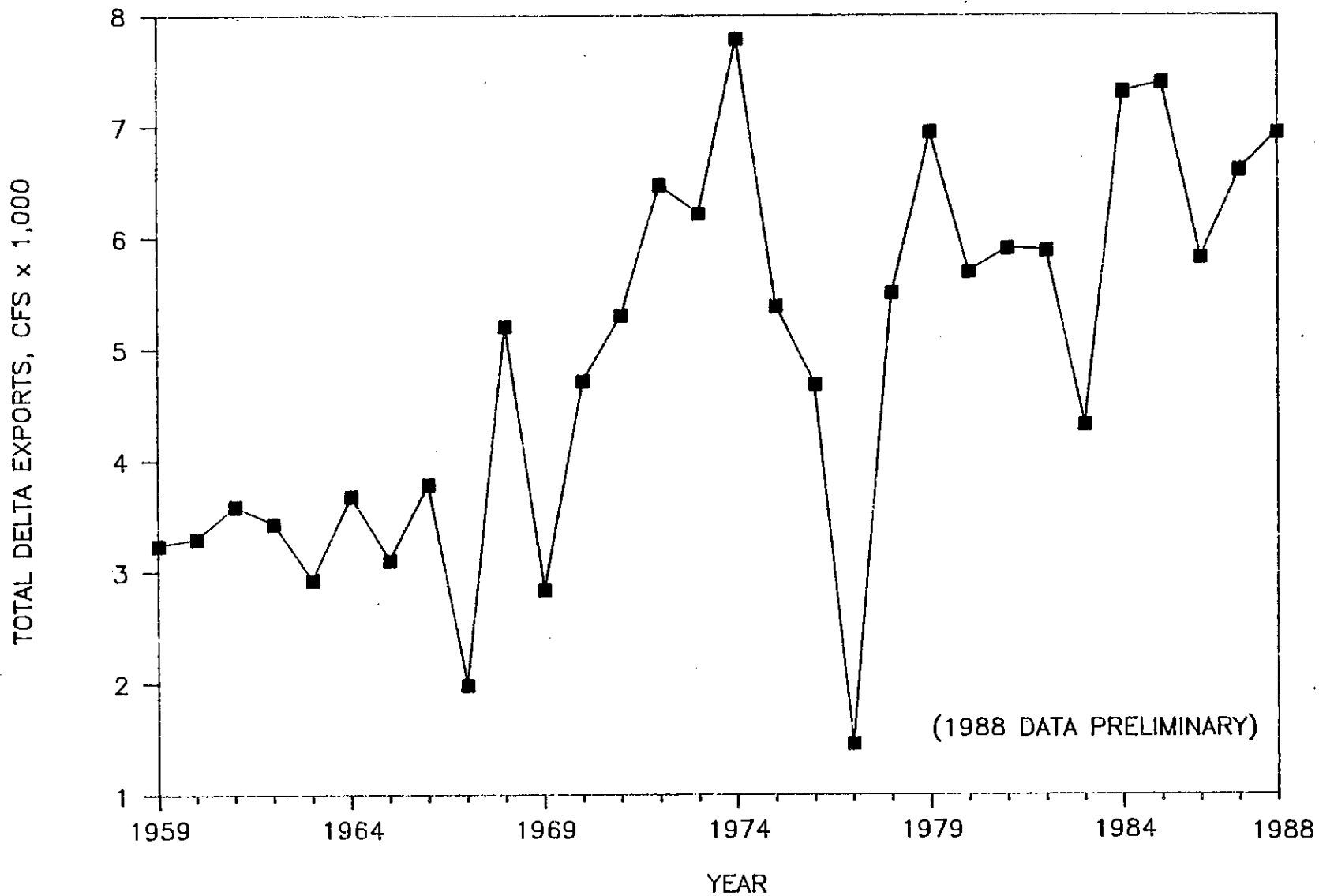

The direct and indirect effects of these increased exports have most likely been the major factor in the recent decline of striped bass. As noted above, four of the five hypotheses proposed by the SWC are directly or indirectly related to flows and exports. All the participants acknowledge that exports and their attendant effects on flows in the Delta do have deleterious effects on striped bass. Below are presented the particular problems related to striped bass and the proposed recommendations to provide them optimal protection. These recommendations are summarized in Table 5.3.5.3-1. Acceptance or rejection of the proposed objectives of the participants will be discussed. As noted above, the proposal to retain the current standards is rejected.

TABLE 5.3.5.3-1
OPTIMAL LEVELS OF PROTECTION FOR STRIPED BASS

| Time | Location | Recommendation | Protection |
|----------------------------------|---|---|---|
| April 1--June 15 (all years) | San Joaquin R. Vernalis to Antioch Bridge | Maximum daily EC not to exceed 0.3 mmhos/cm | Adult striped bass migration and spawning |
| April 15--July 31 (all years) | Delta Cross Channel gates | Closed | Reduce trans- location of eggs and larvae |
| April 1--July 31 (all years) | Statutory Delta channels | No withdrawals or exports (except for emergency) | Reduce egg and larva entrain- ment |
| April 1--May 31 (all years) | Chippis Island | Daily Delta outflow at least 33,900cfs | Move larvae to Suisun Bay nursery area and keep null zone at Honker Bay or down- stream |
| June 1--June 30 (all years) | Chippis Island | Daily Delta outflow at least 32,400 cfs | Move larvae to Suisun Bay nursery area and keep null zone at Honker Bay or down- stream |
| July 1--July 31 (all years) | Chippis Island | Daily Delta outflow at least 29,100 cfs | Move larvae to Suisun Bay nursery area and keep null zone at Honker Bay or down- stream |
| April 1--July 31 (all years) | Vernalis | San Joaquin River component of Delta outflow equal to or greater than proportion under unimpaired flow | Maintain positive down- stream flow in all Delta channels |

- Problem 1: Adult Striped Bass Spawning is Affected by Limitations on the Spawning Area.

DFG has testified that the formation of a salinity barrier in the mainstem San Joaquin River above Venice Island tends to restrict spawning runs and spawning activity in that area (T,XLI,68:1-69:10). DFG also testified, and other evidence shows, that historically striped bass did spawn above the Delta in the San Joaquin River system. Striped bass are not able, under Delta Plan standards, to fully use the historical spawning habitat.

Current Delta Plan standards provide for a maximum of 0.550 mmhos/cm EC at Prisoners Point, on the San Joaquin River from April 1 to May 5. DFG data (DFG,25,44-46) (shows that striped bass will not migrate through the eastern Delta into areas where EC is greater than 0.55 mmhos/cm. In addition, the majority of striped bass spawn in water with EC less than 0.3 mmhos/cm. Thus, the Delta Plan standard effectively blocks upstream migration of striped bass in the San Joaquin River beyond Prisoners Point in drier years, and may have an impact on spawning as well. The short period of time (35 days) which is covered by the Delta Plan standards may also be inadequate to provide full use of the San Joaquin River migration and spawning habitat.

There are two aspects to the solution of this problem: Sufficient flows must be provided to break up this salinity barrier, and water quality in the San Joaquin River must be appropriate to promote migration and spawning upstream. Both can be accomplished by providing water of sufficient quality and quantity at Vernalis, provided that exports are not too large to prevent adequate flow down the mainstem San Joaquin River below Mossdale, and that the protection period is of sufficient length to utilize the habitat fully.

None of the participants proposed any objectives to solve this problem, other than general proposals for greatly increased outflows for striped bass larvae. However, since San Joaquin River flows were not stipulated in these recommendations, it is assumed that this problem was not being specifically addressed.

Based on evidence received, there appears to be no particular problem for adult striped bass, relative to habitat, in the Sacramento River, or to temperature regimes in either the Sacramento or San Joaquin rivers, since spawning tends to be initiated by increasing temperatures. The effects of warmer water in recent years is discussed below in relation to periods of time in which the objectives should apply.

- Recommendation 1: Electrical conductivity in the mainstem San Joaquin River from Vernalis downstream to the Antioch Bridge should not exceed a daily maximum of 0.300 mmhos/cm from April 1 to June 15 in all water year types.

- Problem 2: Eggs and Larvae are Translocated into the Central Delta through the Delta Cross Channel and Georgiana Slough.

Eggs and small larvae of striped bass are carried passively down the Sacramento River and are transported into the central Delta through the Delta Cross Channel and Georgiana Slough. Translocation to the central Delta exposes the eggs and larvae to increased mortality (DFG,25,54). The Delta area is less suitable as a nursery habitat than the Suisun Bay area. Screening is not effective for these small eggs and larvae.

Existing Delta Plan standards call for closing of the Delta Cross Channel gates when the Delta outflow index (DOI) is above 12,000 cfs, but various conditions apply: DFG must request a closure, the potential closure period is only from April 16 through May 31, the maximum number of days available for closure within this period is 20, and no more than two out of four days may be consecutive. DFG has proposed expanding this standard to include closure when the DOI is less than 12,000 cfs, but for only a total of ten days in the period, and no more than one day out of four. Closure periods should be determined by real-time monitoring (DFG,64,7). The USFWS called for closure of the Delta Cross Channel gates and for modification of export operations "when densities [of eggs and larvae] are high" (USFWS,47,5). This recommendation is broader than the DFG recommendation, in that it appears to allow for more flexibility in the closure period to accommodate differences between years in striped bass spawning, but "high densities" is undefined. Neither recommendation provides optimal protection, however, since neither seeks to isolate Sacramento River eggs and larvae from the central Delta entirely.

Georgiana Slough has no gates on it at present. Georgiana Slough intercepts little more than about 13 percent of the Sacramento River flow at Freeport (DAYFLOW documentation). Given the other recommendations proposed below to enhance downstream flows in the central Delta, no recommendation for protection of striped bass passing into Georgiana Slough appears to be warranted. However, losses through the Delta Cross Channel are larger, and protection can be provided with present facilities. In the absence of proven technology to provide real time monitoring, and because of the need to provide full protection, the following recommendation is made.

- Recommendation 2: The Delta Cross Channel gates should remain closed for the period April 15 through July 31 in all water year types.

The above sets of recommendations are all inadequate to protect striped bass eggs and larvae fully because none provide flows sufficient to move all larvae out of the central Delta into Suisun Bay nursery areas in all year types. In addition, none call for curtailment of exports to reduce reverse flows and entrainment. On the other hand, the EDF, recommendation for 38,000 cfs seems excessive since DFG believes that 33,900 cfs will move 100 percent of the eggs and larvae past Collinsville. Since no recommendations for April flows were received, the DFG standard will be applied to April as well as May. April standards are needed because significant spawning occurs in the Delta in April, and these eggs and larvae also require protection.

The outflow recommendations proposed will still not assure positive downstream flows in all Delta channels. In particular, exports from the Delta by the SWP and CVP can induce reverse flows in Old and Middle rivers. Eggs and larvae in the central Delta can be drawn into these channels and entrained in the export facilities and agricultural diversions, or be carried to areas of the Delta which are unsuited for their survival. In addition, if, as a result of removal of the salinity barrier on the San Joaquin River, spawning returns to the area around and above Vernalis, eggs and larvae produced upstream will be pulled into Old River and entrained into the export facilities. These factors represent additional mortality for young striped bass.

Based on the above discussion, a series of recommendations to address these interrelated problems are proposed:

To prevent entrainment of striped bass eggs and larvae in municipal, industrial, and agricultural diversions and export facilities in the Delta:

- Recommendation 3-1: No withdrawals or exports of water from the statutory Delta for any purposes other than for emergency conditions should be permitted for the period April 1 through July 31 in any water year type.

To assure movement of striped bass eggs and larvae into the Suisun Bay nursery area and to keep the entrapment zone west of Collinsville:

- Recommendation 3-2: Daily Delta outflow should be no less than the following in all water year types:

| | |
|------------------------|-----------------|
| April 1 through May 31 | -----33,900 cfs |
| June 1 through June 30 | -----32,400 cfs |
| July 1 through July 31 | -----29,100 cfs |

- Problem 3: Striped Bass Eggs and Larvae in the Central Delta are Lost in Large Numbers.

Considerable evidence has been presented by DFG and USBR, among others, to demonstrate that the central Delta is not an appropriate environment for survival of eggs and larvae of striped bass. The primary causes of these losses are entrainment in agricultural diversions, export facilities and M&I intakes. In addition, the reverse flows and longer residence times induced by the export pumps result in increased starvation of and predation on eggs and larvae. Flows are required to move the eggs and larvae down stream of Collinsville on the Sacramento River and into the Suisun Bay nursery area. Calculations developed by DFG (DFG,64,8) based on egg and larva sampling programs have determined that a Delta outflow of 33,900 cfs in May will move 100 percent of six mm striped bass larvae into the Estuary west of Collinsville. Equal protection in June would require 32,400 cfs, and in July (for seven mm fish, the smallest size class still present in that month) 29,100 cfs. The exhibit does not specify what export levels were present when the data to develop these calculations were collected. Nor does the exhibit present any indication of how the flow should be proportioned between the Sacramento and San Joaquin rivers. Despite evidence that spawning in the central Delta and the San Joaquin River occurs in April (DFG,64,9), no flow requirements or recommendations were presented for the month of April.

USFWS recommendations (USFWS,47,5) basically support those of DFG, but also recommend that Delta outflow be not less than 10,000 cfs during the May through July period, and that reverse flows be eliminated in the lower San Joaquin River at Jersey Point. No recommendations for Delta outflow in April, for required flows in the San Joaquin River, or for elimination of reverse flows in Old and Middle rivers were presented.

As discussed above (see section 5.3.5.2), EDF proposed Delta outflows based on the DFG data but weighted for the abundance of larvae in different months (more larvae present in May, fewer in July). EDF Exhibit 25 calls for flows of 38,000 for the period May 6 through May 31 in wet years, decreasing to 21,000 cfs in critical years. Lesser flows are proposed for the months of June and July. As with DFG and USFWS, no flow is apportioned to the San Joaquin River.

To assure that positive downstream flows are maintained in all Delta channels and to move eggs and larvae downstream from the San Joaquin River system:

- Recommendation 3-3: The contribution of the San Joaquin River to the total Delta outflow should be at least equal to that proportion of flow which would be present under unimpaired flow conditions.
- Problem 4: Disruptions of the Striped Bass Food Chain have occurred

Striped bass may be starving because of loss of food from the central Delta. DFG presented evidence to indicate that zooplankton are becoming depleted, or the species composition of zooplankton has changed in the central Delta. This may have detrimental effects on striped bass when they first begin feeding (DFG, 25, 95-102).

- Recommendation 4: The above recommendations to maintain downstream flows in all Delta channels and to move the larvae rapidly into the Suisun Bay nursery area, where food of the appropriate species composition is available and more plentiful, should provide appropriate resolution of this problem. Should the other recommendations not be fully implemented such that the zooplankton food problem needs to be addressed, separate recommendations will be developed at that time. However, for the present, no recommendation for the protection of striped bass food supply is made.
- Problem 5: Pollutant Burdens

Adult striped bass are burdened with a variety of pollutants which may affect their survival and reproductive potential. DFG and other participants have introduced evidence to indicate that adult striped bass are burdened with various organic and inorganic pollutants, which may affect their survival and their ability to reproduce, particularly through resorption of eggs in the ovaries. In addition, certain of these contaminants may pose a health risk to humans if striped bass are consumed too often. DFG fishing regulations include a precaution against consumption of too much striped bass because of mercury levels in their flesh.

- Recommendation 5:

This subject is not directly relevant to Water Quality Control Plan standards. Actions proposed in the Pollutant Policy Document may have beneficial effects for striped bass. Other related recommendations are discussed in Chapter 8.

- Problem 6: Attraction to Effluents

Evidence presented by DFG indicates that some striped bass may be attracted to certain components of industrial effluent streams and suffer deterioration and starvation. Laboratory tests indicate that the fish are attracted even when these chemicals are extremely diluted. The fish tend to remain in the effluent streams even though little or no food is available, and they undergo fin rot.

- Recommendation 6: Additional study of this phenomenon is warranted (see Chapter 8). Actions proposed in the Pollutant Policy Document may also have beneficial effects for striped bass.

- Other Problems and Considerations

The above recommendations represent those levels of flow, salinity, and operational constraints which will, in theory, provide optimal protection for the striped bass beneficial use. Certain aspects of the problem of the decline of striped bass, such as pollutants, the Suisun Bay spring die-off, and effects of upstream diversions on survival of eggs and larvae, are beyond the scope of this Plan, in that they are not directly related to flow and salinity considerations in the Estuary.

- Hatcheries

Certain other corrective or mitigative measures, such as hatcheries or grow-out facilities for fish salvaged at the export pumps, may be capable of providing some protection for striped bass. The question of hatchery production should not be considered at this time. Although there has been some recent success in producing striped bass in the hatchery, the fate of those fish in the Estuary (and ocean) and their recruitment to the fishery have not yet been determined. In addition, and most critically, even if some hatchery fish are recruited to the fishery and produce viable eggs and larvae, the purpose of that recruitment is lost if those eggs and larvae are subsequently lost to the fishery because of the various problems discussed above. Likewise, the question of other facilities cannot be addressed at this time, since no specific facilities have been proposed.

- Relationship of Recommended Outflows to Unimpaired Delta Outflow

The Delta outflow recommendations proposed in Recommendation 5 above are as follows: 33,900 for April 1 through May 31; 32,400 for June 1 through June 30; and 29,100 for July 1 through July 31 in all years. Based on data developed for SWRCB exhibits, for unimpaired flow at Chipps Island for the years 1922-1978, the objective will be met with unimpaired flows as shown below:

| Year Type | April | May | June | July |
|--------------|-------|-----|------|------|
| Wet | A | A | A | S |
| Above Normal | A | A | M | N |
| Below Normal | A | A | S | N |
| Dry | M | N | N | N |
| Critical | S | N | N | N |

A = recommended flow level met in all years
M = recommended flow level met on average; met in most years
S = recommended flow level met in some years; not met on average
N = recommended flow level not met in any year

5.3.6 American Shad--Protection of Beneficial Uses

5.3.6.1 No Action Alternative

Under the Delta Plan there are essentially no standards to protect American shad. While the impacts of the Delta Plan on shad could not be quantified, it noted that the recommended plan for striped bass protection was expected to provide shad protection as well in wet, above normal, and dry water years, with a "definite lessening of protection" in critical years (Plan, V-39, VI-9).

The only specific standards for shad proposed in the Delta Plan (Table VI-1, pg. VI-35) concerned operation of the CVP's Tracy Fish Protective Facility. Certain secondary velocities and bypass ratios are required "to the extent possible" between June 1 and August 31 to increase screening efficiency for shad and other species. However, these standards are to be met "to the extent that they are compatible with export rates." Thus, shad protection is incidental to the operation of the CVP export pumps. There are no standards addressing shad for the SWP pumps.

5.3.6.2 Advocate Recommended Levels of Protection:

- WACOC

WACOC recommended continuing the current practice of relating flow requirements for the protection of fish and wildlife to the variation of each year's runoff and storage conditions. Specifically, flow requirements "should be

relaxed proportionately in the drier years to meet the reasonable beneficial needs of people, while maintaining reasonable minimum water quality standards for fish and wildlife" (WACOC,4,8).

- BISO/SCLDF

BISO and SCLDF discussed three "perturbations" and resulting adverse effects on shad (BISO-SCLDF, Brief,57-58). These perturbations were: reduced river flow, reduced food supply for young fish, and losses of fish entrained in water diversions. General statements on corrective measures were presented, but no specific objectives were proposed.

- DFG

DFG discussed the present level of knowledge about shad (DFG,23). They made no specific recommendations for protection of shad (DFG,64,12) because they believe the recommendations for protection of striped bass will provide benefits to American shad as well (see discussion of striped bass recommendations in Section 5.3.5.3).

- USFWS

USFWS proposed an overall goal of increasing young-of-the-year (YOY) production of shad. Two main mechanisms ("objectives") were proposed to accomplish this goal. The first is to increase Delta inflow from April to June according to striped bass and salmon flow needs. Though unstated, USFWS appears to support DFG's basic determination that recommended flows for salmon and striped bass will benefit shad as well. The second objective is to reduce fish translocations from the Sacramento River into the central Delta during July to September. This reduction would make the larvae less susceptible to entrainment in all Delta water diversion facilities, and specifically would reduce entrainment at CVP and SWP facilities. A variety of implementation measures are proposed (USFWS,47,6).

5.3.6.3 Optimal Levels of Protection:

The testimony and exhibits indicate that current standards do not fully protect American shad. Evidence for this conclusion comes from several areas:

- The abundance of adult shad appears to have declined from levels early in this century, and more specifically from about 1945 on, although specific population measurements from those years are not available (DFG, 23, 1; DFG, 23, 16; T, XXXIX, 13: 15-17).
- The range of spawning runs has declined, particularly in the San Joaquin River system, where runs in both the mainstem San Joaquin and its tributaries used to occur (DFG, 23, 2; T, XXXIX, 14: 5-11; 31: 5-11; 47: 7-25).

- Up to 4.4 million shad have been salvaged annually at the CVP and SWP export pumps, and about half of those salvaged do not survive; many more larvae and small fish are entrained and lost (DFG, 23, 20-22; T, XXXIX, 17: 4-18: 4).
- Evidence was presented to indicate that a variety of factors may be involved in the current limited protection for shad. Each factor will be discussed in turn, followed by recommendations for optimal protection. The recommendations for optimal levels of protection are summarized in Table 5.3.6.3-1.
- Problem 1: Effects of Decreased River Flows on Spawning Runs.

Decreased flows in the Sacramento and San Joaquin rivers and their tributary streams have reduced spawning runs or have limited the dispersion of adult shad into tributary streams (DFG, 24, 4; DFG, 23; T, XXXIX, 14: 12-22; 16: 14-18; 31: 5-9; 33: 12-34: 14). According to DFG testimony, actual inflow to the Delta in the spring was 32 to 66 percent less than would have been available under unimpaired inflows for the years 1978-1982 (DFG, 23, 24). USEWS (USEWS, 47, 6) has recommended that Delta inflow should be increased in the April-June period according to levels demonstrated by DFG to have positive effects on shad YOY production. DFG's data (DFG, 23, 19) are shown in Figure 4.5.1.4-1. This relationship appears to have a decided break near the 20,000 cfs level; above this level of Delta inflow the relationship between YOY shad abundance and inflow does not appear to be statistically significant. However, since spawning continues into early July, the period of protection should extend beyond that recommended by USEWS (T, XXXIX, 14: 23-24).

- Recommendation 1

Total daily Delta inflow in all year types should be a minimum of 20,000 cfs from April 15 to July 15. The contribution of the San Joaquin River to total Delta inflow should be at least equal to that proportion of flow which would be present under unimpaired flow conditions.

- Problem 2--Effects of Flow on Larval and YOY Shad.

Variations in flows in the Sacramento and San Joaquin rivers and their tributaries may affect the distribution and outmigration of larval and YOY American shad (DFG, 23, 10; T, XXXIX, 16: 4-11; 16: 23-17: 3). Lower flows may concentrate the larvae in limited areas, resulting in depletion of the food supply. Lower flows also lengthen the time required for larvae to get to suitable nursery habitat (DFG, 23, 23). Appropriate flows are required to disperse and transport the eggs, larvae and YOY down the tributary streams and through the Delta. Some young shad do not migrate through the Delta immediately but remain in summer nursery areas in the Sacramento and Feather rivers and the southern Delta. These shad begin their outmigration through the Delta later in the

TABLE 5.3.6.3-1
OPTIMAL LEVEL OF PROTECTION FOR
AMERICAN SHAD

| Time | Location | Recommendation | Protection |
|-----------------------------------|--|---|---|
| April 15--July 15 (all years) | Delta | Minimum daily total Delta inflow cfs. San Joaquin R. component at least equal to proportion of total inflow present under unimpaired flow | Adult shad migration and spawning habitat |
| May 1--November 30 | Delta | Same as Above | Egg and larval outmigration, nursery habitat, zooplankton |
| May 1--November 30 (all years) | Delta Cross Channel Gates | Closed | Reduce translocation of eggs and larvae |
| May 1--November 30 (all years) | Statutory Delta Channels & SWP, CVP, CCC | No withdrawals or exports (except for emergencies) | Reduce egg, larval and YOY entrainment |

year and continue to do so at least through November (DFG, 23, 10-11). Flows are required to facilitate this late outmigration as well as the spring and early summer outmigration (May to July). In order to restore runs in the San Joaquin River and its tributaries, total Delta inflow should be divided between the Sacramento River and the San Joaquin River in proportion to what would be present under unimpaired flow conditions.

- Recommendation 2

Total daily Delta inflow in all water year types should not be less than 20,000 cfs from May 1 to November 30. The contribution of the San Joaquin River to total Delta inflow should be at least equal to that proportion of flow which would be present under unimpaired flow conditions.

- Problem 3--Losses of Larval and YOY Shad to Diversions and Exports.

Shad larvae and YOY are subject to mortality from diversions and export facilities in the Delta. Shad originating in the Sacramento River system may be translocated into the central Delta, resulting in entrainment in local agricultural diversions (DFG, 23, 20; DFG, 23, 25) which are for the most part unscreened (T, XXXIX, 17:9-10). These shad, plus those originating in the Delta or the San Joaquin River system, are also subject to entrainment at the CVP and SWP pumps (DFG, 23, 8-11; DFG, 23, 20-21). Although the export facilities have screens, they are ineffective for eggs and small larvae, and larger fish are subject to as much as 50 percent handling mortality because of their fragility (DFG, 23, 20-22; T, XXXIX, 17:11-18:4).

Based on these findings, a series of recommendations is presented as follows:

To reduce translocation of shad eggs, larvae and YOY into the central Delta:

- Recommendation 3-1

The Delta Cross Channel gates should be closed from May 1 to November 30 in all water year types.

To reduce entrainment of shad eggs, larvae and YOY into municipal, industrial and agricultural diversions in the Delta and into the export pumps.

- Recommendation 3-2

No withdrawals or exports of water from the statutory Delta for any purpose other than emergencies should be permitted from May 1 to November 30 in all water year types.

- Problem 4--Disruption of Larval Shad Food Chain.

Abundance of larval shad may be reduced because zooplankton on which they feed are reduced. This reduction in zooplankton abundance may result from direct entrainment in water diversion facilities, or from high net flows in Delta channels, due to export pumping, which provide a less stable environment for zooplankton, (T,XXXIX,18:6-18). The combination of the proposed recommendations and those proposed for protection of other beneficial uses in the Delta and Suisun Bay should provide adequate protection for the shad food chain. Should the proposed measures be determined to not provide adequate protection, separate recommendations specific to zooplankton will be addressed at that time. However, for the present, no recommendation for the protection of the American shad food chain is proposed.

- Problem 5--Loss Measurement and Mitigation.

At present, American shad losses at the SWP export pumps are not covered under the Two-Agency Fish Mitigation Agreement, and there is no agreement for mitigation of losses at the CVP pumps (T,XXXIX,32:24-33:9). In addition, no evaluations of screening efficiency for American shad have been made (DFG,23,20). These factors will be discussed further in Chapter 8.

When combined, recommendations 1 and 2 above require daily total Delta inflow to be at least 20,000 cfs from April 15 to November 30 in all year types, with proportions of San Joaquin River flow the same as would be present under unimpaired flow conditions. The approximate amount of San Joaquin River flow required in the April-November period in different year types, and the probability of meeting those flows under unimpaired flow conditions, are summarized in Tables 5.3.6.3-2--5.3.6.3-4.

Table 5.3.6.3-2 is derived from data used to prepare SWRCB Exhibit 110, and it indicates the average percent of total inflow in the Delta which would originate from the San Joaquin River under unimpaired flow conditions. Table 5.3.6.3-3 converts the percentages to recommended flow values by multiplying each percentage by 20,000 cfs, the recommended level of total Delta inflow. Table 5.3.6.3-4 indicates the unpaired flow at Vernalis (based on model results used in SWRCB Exhibit 110) and indicates the probability of meeting the recommended level of San Joaquin River inflow.

TABLE 5.3.6.3-2 SAN JOAQUIN RIVER - PERCENT OF TOTAL DELTA INFLOW
(UNIMPAIRED FLOW CONDITIONS; 1922 - 1978)

| YEAR TYPE | APR | MAY | JUN | JUL | AUG | SEPT | OCT | NOV | # OF YEARS |
|--------------|-----|-----|-----|-----|-----|------|-----|-----|---------------|
| WET | 20 | 34 | 45 | 43 | 24 | 12 | 6 | 8 | 15 |
| AB NRML | 24 | 38 | 46 | 39 | 18 | 8 | 9 | 11 | 12 |
| BL NRML | 21 | 32 | 39 | 26 | 10 | 8 | 8 | 10 | 14 |
| DRY | 22 | 38 | 36 | 21 | 9 | 6 | 7 | 13 | 6 |
| CRITICAL | 27 | 35 | 29 | 13 | 7 | 7 | 10 | 9 | 10 |

TABLE 5.3.6.3-3 FLOW REQUIRED AT VERNALIS (IN CFS) TO MEET RECOMMENDED
PERCENT OF 20,000 CFS TOTAL DELTA INFLOW

| YEAR TYPE | APR | MAY | JUN | JUL | AUG | SEPT | OCT | NOV |
|--------------|------|------|------|------|------|------|------|------|
| WET | 4084 | 6824 | 8936 | 8657 | 4773 | 2468 | 1194 | 1606 |
| AB NRML | 4769 | 7511 | 9174 | 7710 | 3562 | 1578 | 1800 | 2181 |
| BL NRML | 4220 | 6418 | 7724 | 5280 | 2031 | 1582 | 1582 | 2026 |
| DRY | 4500 | 7506 | 7249 | 4112 | 1727 | 1260 | 1420 | 2523 |
| CRITICAL | 5356 | 6975 | 5825 | 2540 | 1400 | 1432 | 1920 | 1869 |

TABLE 5.3.6.3-4 ESTIMATED UNIMPAIRED FLOW AT VERNALIS (IN CFS) AND PROBABILITY
OF MEETING RECOMMENDED FLOW UNDER UNIMPAIRED CONDITIONS

| YEAR TYPE | APR | MAY | JUN | JUL | AUG | SEPT | OCT | NOV |
|--------------|-------|-------|-------|-------|------|------|-----|------|
| WET | 21012 | 37369 | 33876 | 12847 | 3014 | 1249 | 509 | 1818 |
| | A | A | A | A | S | N | N | N |
| AB NRML | 18861 | 28015 | 20695 | 6604 | 1515 | 568 | 831 | 1928 |
| | A | A | A | S | N | N | S | S |
| BL NRML | 12889 | 19490 | 15059 | 3861 | 815 | 356 | 752 | 3134 |
| | A | A | M | S | N | N | S | M |
| DRY | 10499 | 16214 | 9373 | 1992 | 556 | 449 | 607 | 2828 |
| | A | A | M | N | N | N | N | M |
| CRITICAL | 8823 | 9773 | 4676 | 966 | 465 | 537 | 963 | 1021 |
| | H | M | S | N | N | S | S | S |

=====
A = MET IN ALL YEARS
M = MET ON AVERAGE; MET IN MOST YEARS
S = MET IN SOME YEARS; NOT MET ON AVERAGE
N = NOT MET IN ANY YEAR

5.3.7 Suisun Marsh Wildlife Habitat Beneficial Use Alternative

5.3.7.1 No Action Alternative

Absent any other action by the Board, operators of the SWP (DWR) and the CVP (USBR) will continue to be bound to meet the wildlife protection terms of the Delta Plan. These terms include measures to meet or exceed certain standards for water quality in the channels of the Delta and Suisun Marsh (SWRCB, 1978, 22). The terms for protection of wildlife were unchanged by the 1985 amendments, except for some changes in monitoring locations, and time for implementation. The original terms required permittees DWR and USBR, in cooperation with other agencies, to develop by July 1, 1979, a plan for protection of the Suisun Marsh (Marsh Plan). This Marsh Plan together with EIR/EIS documentation, was to provide a monitoring network, construction of physical facilities, operation and management procedures for the facilities and assurances by land managers to maintain the Marsh as a brackish water wetland (SWRCB, 1978, 26). The permittees were required to manage the Marsh to produce high quality feed and habitat for waterfowl and other wildlife and to implement the Marsh Plan for full protection of the Marsh by October 1, 1984 (SWRCB, 1978, 26-27). Subsequent extensions of time and modifications to monitoring locations were granted by the Board (DWR, 505).

In the event the Board takes no action, the terms of the Delta Plan, as extended in 1985, remain in effect. These terms provide interim partial protection to Suisun Marsh wildlife in the managed wetland area as well as in part of the natural tidal brackish water marsh area (SWRCB, 14, VII-4). Approximately 40 percent of the 10,000 acres of unmanaged tidal brackish marshes around Suisun Bay were originally protected by the Delta Plan BCDC, 5, 12; BAAC, 4; USFWS, 17; 18; 19; 20).

5.3.7.2 Advocated Levels of Protection

- o DWR, USBR, DFG, SRCD--Four Party Agreement

At the Phase I of the hearing that addressing wildlife, DWR provided testimony and exhibits describing the measures agreed upon by DWR, USBR, DFG and SRCD (hereafter referred to as Four Parties) to meet the the Delta Plan requirements (DWR, 503; 504; 506A; 506B; 507A; 507B; 508A; 508B; 509; 510; 511; 512; 513; 514; 517 A-B; 518; 519; 520 & 521). The measures included a Suisun Marsh Preservation Agreement, a Mitigation Agreement, a Monitoring Agreement, and a Plan of Protection for the Suisun Marsh.

There are differences between standards set in the Delta Plan and its extension (used herein as the No Action Alternative) and those agreed upon by the Four Parties. Principal differences are the addition of a dry year modification of water quality standards in the Suisun Marsh, changes in the Chipps Island EC standard and a lower minimum mean monthly Delta Outflow Index (DWR, 506(B), 5). The

monitoring requirements in the Delta Plan for the Suisun Marsh (Terms 4 and 5) are silent on rare, threatened, or endangered species, although by inference the plan of protection (Marsh Plan) required in Order term 7(a) is intended to ensure protection of all Marsh wildlife. The monitoring agreement developed by the permittees calls for census and surveys of only the salt marsh harvest mouse, and these would only be done if changes in the general plant community are found (DWR,508 B,3). There are no provisions for monitoring other threatened or endangered plants or animals. The Board has not yet found that the plan of protection, which was required under the Delta Plan and prepared by DWR, DFG and USBR (DWR,511) is fully consistent with Term 7(a) of the Delta Plan. According to testimony, the Four Parties have an agreement to implement the plan of protection they have developed (T,XXIX,27,7-23), including the monitoring. The agreement binds the parties to petition the Board to find that the actions are appropriate to protect the Marsh and to substitute the proposed standards for Delta Plan standards (DWR 506A,14,15). There is nothing in the agreement which requires it to be approved by the Board. Thus, in the event of no action by the Board, the parties to the agreement would be obligated to continue to operate their projects under the D-1485 amended standards. These call for standards to be met at some locations on October 1, 1988; in the northwestern Suisun Marsh on October 1, 1991; in the southwestern Marsh on October 1, 1993; and in Suisun Slough at Volanti Slough and at Chipps Island and Van Sickle Island waterfowl management area water supply intakes on October 1, 1997 (DWR,505,1-2).

- BCDC

Experts testifying on behalf of BCDC proposed that the Board revoke its decision of December 5, 1985 amending the standards compliance schedule in the Delta Plan and changing the locations (BCDC,5,31;T,XXIX,238:22-25). The BCDC testimony also proposed an additional standard to protect tidal marshes adjacent to Suisun Bay (BCDC,5, T4;T,XXIX,239:25-240:2). It is BCDC's position that the Board's 1985 amendments to the Delta Plan reduced protection for unmanaged tidal marshes as well as delaying the implementation of measures to protect water quality and beneficial uses in the managed wetlands of the Suisun Marsh (BCDC,5,5).

- BAAC

BAAC recommended a flow and salinity standard which provides greater protection for brackish water tidal marshes than does the Delta Plan (T,XXX,52:6-22). In addition, recommended salinity standards for water quality in tidal marshes (levels not specified) be set for summer rather than ending in May (T,XXX,54:10-21). The position of BAAC was that the brackish water marshes have already been degraded

and they would like to see them improved and restored more toward their natural condition, which would require more stringent salinity standards (T,XXX,94:20-95:2). The BAAC testimony did not explicitly state what those freshwater flows or what salinity standards should be to adequately approach natural conditions.

- PRBO

PRBO advocated freshwater outflow through the Golden Gate as a means to provide a food supply to seabirds ten to 15 miles away in the Farallones National Marine Life Refuge (T,LIV,140:6-143:8). The San Francisco Bay plume of freshwater is an important foraging area in April and May (T,LIV,145:10-12,21-24). The salinity differential and nutrient input produce a concentration of food organisms for seabirds (T,LIV,150:17-23). Birds use the plume for feeding when the normal marine food web closer to the Farallon Islands fails to develop (T,LIV,154:21-23). According to PRBO testimony, during El Nino events, when upwelling of deep-coastal water is less than normal, marine food chains are less productive and seabirds are more dependent on the San Francisco Bay plume (T,LIV,155:10-14). El Nino events are possible during dry years (T,LIV,155:4-6). The PRBO position is that if the plume is less extensive or less frequently close to the Farallones during the breeding season, seabirds which feed there will decline in abundance (T,LIV,160:24-161:1). During cross-examination, it became clear that the linkage between bird populations and the size of the plume is not completely predictable, as populations have increased during some El Nino periods when there was little outflow, such as 1977 (T,LIV,164:8-23). In other years, El Nino events coincided with extraordinarily wet years (T,LIV,154:19-155:1). The plume is a primary foraging area from February through May, while birds resort to the plume if it is present and if upwellings fail during June and July (T,LIV,161:22-24; T,LIV,162:20-22). No testimony or evidence was provided to indicate how often El Nino years would coincide with low outflow under unimpaired conditions.

5.3.7.3 Optimal Level of Protection

Considerations which were not addressed in detail in prior hearings on the Bay-Delta Estuary include the beneficial uses of water by threatened and endangered species. Protection for these species is required by both the state and federal Endangered Species Acts. The Delta Plan did not weigh the obligation of non-project diverters to protect water quality for endangered species or other public trust beneficial uses. The Board has the authority, as the public trustee of water quality for fish and wildlife, to condition all water uses to reasonably protect fish and wildlife including threatened and endangered species.

The salinity of water provided to tidal wetlands of the Suisun Marsh influences the survival and reproduction of marsh plants. For example, the California Native Plant Society (CNPS) exhibit (CNPS,3) and testimony (T,XXX,66:11-25;T,XXX,67:2-13;T,XXX,76:15-23) identified five rare, threatened or endangered plant species, four of which would be less likely to survive, have reduced growth or seed production, or become less numerous because of changes in flow or salinity in the Suisun Marsh portion of the Bay-Delta. Some 50 additional species would be indirectly affected, becoming less abundant or widespread as a result of land use changes induced by newly available water supplies (T,XXX,110:25-111:23). The directly affected rare plant species occur in the tidal marshes. The CNPS testimony indicates that even during normal years, freshwater flow to the Suisun Marsh has been insufficient to prevent reductions in productivity (T,XXX,,79:18-20).

With rare species, once a population is eliminated, it is very unlikely to reinvade because of the scarcity of seed sources. Thus, although common species such as alkali bulrush may be adequately protected or able to recover from higher salinity exposure during a critical dry year, rare species would be at risk (T,XXX,81:22-24). A salinity standard capable of preventing reductions in numbers and range of threatened or endangered species might therefore require a smaller dry year adjustment of the salinity standard. It would have to be set at a level at which the species were capable of sustaining normal survival, productivity and germination. The Suisun Marsh Preservation Agreement, proposed by the Four Parties, does not adequately address these needs in its proposed standards. It is therefore recommended that the Board retain jurisdiction to require additional protection for sensitive special status species rather than fully endorse the Agreement.

Suitable pore water salinity for five sensitive plants ranges from zero to minus two megapascals (comparable to a range of zero to four parts per thousand (ppt) salinity, or electrical conductivity of zero to 6.25 mmhos/cm) for freshwater plants in the Delta (California hibiscus, Delta tule pea) to minus two to minus three megapascals in Suisun Marsh (four ppt to six ppt, 6.25 to 9.36 mmhos/cm) for Mason's lilaepsis and Suisun aster, which tolerate somewhat brackish conditions (T,XXX,76:5-23). On the other hand, salt marsh bird's beak which grows in saline areas could tolerate minus four to minus five megapascals (eight ppt to ten ppt, 12.5 to 15.6 mmhos/cm). These pore water potentials should not occur until after the growing season, which extends from March to July (T,XXX,79:12-14).

The DFG has proposed a method to produce certain salinities in the root zones of managed wetlands based on surface water quality and timing of applied water (DFG,5,T3). To protect the unmanaged vegetation along the channels of the adjacent tidal marsh, comparable application timing and water quality to that DFG proposed for managed wetlands may be needed. If this standard were set, it would require studies relating pore water salinities in the root zones of rare plants to flow and

salinity in channels adjacent to those plants. There is little information in the exhibits or testimony which addresses the relationship between the salinity of applied water and the pore water salinity outside of managed wetlands. If studies showed pore water salinity remained suitable for sensitive plant species even when channel salinities reached high values, relatively little Delta outflow would be required. Conversely, if studies showed pore water salinities were at levels which cause stress or reduced productivity of threatened or endangered plants, improved water quality in adjacent channels would be needed to prevent a significant impact.

Water quality in Suisun Marsh tidal channels for protection of rare and threatened plant species should therefore conform to the dates and salinity levels specified in DFG's Table 3 (DFG, 5, T3). Further, applied water salinity should remain at or below seven ppt (approximately 10.9 mmhos) through July to fully protect threatened and endangered plant species (T, XXX, 79:12-14). The optimal objective for tidal channels within Suisun Marsh is set forth in Table 5.3.7.3-1. The optimal objective for tidal wetlands adjacent to Suisun Bay, but outside the Suisun Marsh is set forth in Table 5.3.7.3-2. It should be noticed that the likely soil water salinity based on DFG's Table 3 would be at nine ppt in March, April, and May, corresponding to the minus four to minus five megapascals tolerated by salt marsh bird's beak, but unsuitable for Mason's lilaepsis and Suisun aster. The existing distribution of rare, threatened and endangered species is thought to reflect the availability of water meeting the optimal objectives in tidal marshes during recent years. These objectives specifically for plants in the Suisun Marsh, as set forth in Table 5.3.7.3-3, should be continued while the relationship between applied water quality and soil water salinity in the rare plant root zone along tidal channels is determined. Provision of water meeting these objectives to managed wetlands only would not guarantee protection threatened and endangered species on tidal channel wetlands.

TABLE 5.3.7.3-1

OPTIMAL LEVEL OF PROTECTION FOR WILDLIFE
(Including Rare, Threatened and Endangered)
USE IN SUISUN MARSH TIDAL CHANNEL WETLANDS

| Time | Location Station, Name | Level of Protection (Section Proposed) | Species Protected |
|--------------|--|---|---|
| October-July | C2, Montezuma Slough at Collinsville | TABLE 5.3.7.3-3 soil water salinity no more than 9 parts per thousand (PPT) TDS | Suisun aster(SA), Mason's Lilaeopsis (ML) |
| " | D7A, Grizzly Bay | during growing season, met by providing a schedule of lowering salinity in channels | salt marsh harvest mouse (SMHM), California clapper rail (CR) |
| " | D10, Chipps Island | prior to growing season by maintaining 7 PPT TDS in channels through July of all year types. (Footnote 1) | CR, Delta tule pea (TP) |
| " | S10, Suisun Slough at Boynton | | CR, SA, slough thistle (ST) |
| " | S17, Cordelia Slough at Ibis | | TP |
| " | S31, Suisun Slough at mouth | | CR, SMHM |
| " | S94, Suisun Slough at Hunter's Cut | | SA, TP |
| " | S42, Suisun Slough at Volanti Slough | | CR, SMHM, ML |
| " | S48, Montezuma Slough at Cutoff Slough | | TP, SMHM, soft bird's beak (SBB) |
| " | S63, Denverton Slough | | SBB |
| " | S93, Hill Slough | | CR, SMHM, SA, ML |

Footnote 1: Objectives based on DFG,5,T3.

TABLE 5.3.7.3-2

OPTIMAL LEVEL OF PROTECTION FOR WILDLIFE
(Including Rare, Threatened and Endangered)
USE IN SUISUN BAY TIDAL CHANNEL WETLANDS
OUTSIDE SUISUN MARSH

| Time | Location Station, Name | Level of Protection (Section Proposed) | Species Protected |
|----------------------|-----------------------------------|---|---|
| Oct-May All Years | 8, Point Edith | Same as original D-1485, Table II | black rail (BR), salt marsh harvest mouse (SMHM), least tern (LT) |
| " | D8b, Middle Point, Suisun | " | BR, SMHM, LT, California clapper rail (CR) |
| " | 9, Port Chicago | " | SMHM, CR |
| " | D9a, Spoonbill Cut | " | CR, SMHM |
| " | D11a, Sherman Lake | " | Mason's Lilaepsis (ML) |
| " | 12, Brown's Is. | " | CR, ML, Suisun aster (SA) Delta tule pea (TP) |
| " | 13, Antioch | " | SA, SMHM, ML |
| " | 21, Point Sacramento | " | ML |
| " | f57, Suisun Bay at Roe Is. | " | CR |
| " | f59, Suisun Bay at Seal Island | " | CR |

TABLE 5.3.7.3-3

OPTIMAL OBJECTIVES FOR SALINITY OF WATER IN SUISUN MARSH
TIDAL CHANNELS TO MAINTAIN SENSITIVE PLANT SPECIES*

| Month | Applied Water Salinity | | Pore Water Salinity | | Ratio, Pore Water Salinity to Applied Water Salinity |
|----------|------------------------|------------------|---------------------|------------------|--|
| | EC (mmho/cm) | TDS (p/thous) | EC (mmho/cm) | TDS (p/thous) | |
| October | 18.8 | 12 footnote 1 | 50.0 | 32 | 2:1 |
| November | 15.6 | 10 footnote 2 | 37.5 | 24 | 2:1 |
| December | 15.6 | 10 | 31.2 | 20 | 2:1 |
| January | 12.5 | 8 | 25.0 | 16 | 2:1 |
| February | 7.8 | 5 | 15.6 | 10 | 2:1 |
| March | 7.8 | 5 | 14.1 | 9 | 1.8:1 |
| April | 10.9 | 7 | 14.1 | 9 | 1.3:1 |
| May | 10.9 | 7 | 14.1 | 9 | 1.3:1 |
| June | 10.9 | 7 footnote 3 | 14.1 | 9 | 1.3:1 |
| July | 10.9 | 7 | 14.1 | 9 | 1.3:1 |

- 1/ The salinity of water applied in October (12 ppt) dissolves surface salts and is increased by 4 ppt (to 16 ppt), hence the 32 ppt TDS in the soil, which has a 2 to 1 ratio to applied water salinity (DFG,5,T3).
- 2/ The salinity of water applied in November is increased by 2 ppt TDS (to 12 ppt) due to residual surface salts, hence the 24 ppt TDS in soil (DFG,5,T3)
- 3/ The salinity of applied water and soil water in June and July is assumed to continue unchanged from May.

* Table adapted from DFG,5,22.

5.3.8 Other (i.e., Navigation/Recreation)

Other beneficial uses of the Estuary affected by flow and salinity are commercial navigation, and contact and non-contact-water recreation. Uses that are part of non-contact-water recreation include esthetic appreciation and educational and scientific study (RWQCB 5,1975,5B,I-2-2).

5.3.8.1 No Action Alternative

Under a no action situation, flow and water quality standards established by the Delta Plan would be continued and navigation uses and other beneficial uses would continue to receive the same level of protection they now have.

No explicit standards for the protection of the beneficial uses of navigation or recreation were addressed in the Delta Plan. Because both are among the uses generally considered to fall within the public trust purview, the Board must provide for the protection of these uses, even if no participant addressed the needs during Phase I of the hearing.

Because the existing water quality and fish populations are in large measure attributable to the standards set by the Delta Plan, a no action alternative would provide for continuation of current recreation, navigation and esthetic appreciation beneficial uses.

5.3.8.2 Advocated Levels of Protection

- PICYA/EBRPD

The PICYA prepared and submitted an exhibit regarding beneficial uses relating to recreational navigation, but their exhibit was never made part of the hearing record. The essence of the PICYA submittals was that swimmable, fishable waters which supported existing populations and runs of fish were an important part of their recreational boating experience (PICYA,1,3). In addition, the PICYA document proposed improvements for boat passage at the Delta Cross Channel, protection of existing unveeved Delta islands and maintenance of through navigation (PICYA,4).

EBRPD submitted testimony and exhibits which showed that rapid growth (122 percent increase in two years) in water-oriented recreation was taking place within their jurisdiction (EBRPD,34,1). These two parties emphasized their interest in providing abundant supplies of uncontaminated fish to provide boaters and fishers with an opportunity to experience successful fishing (PICYA,1,3; EBRPD,34,3).

- SWC

SWC presented testimony and exhibits which estimated the economic value of recreation at CVP and SWP reservoirs and proposed that flow reduction in the Delta would be of less economic harm than reduction in flows to reservoirs and canals in the export area (SWC,66,13). No explicit objectives for flow or salinity were proposed by SWC for the protection of recreational uses in the Bay-Delta. SWC argued instead that added diversions would have no effect on recreational fishing, and be to the state's economic advantage, because of higher recreational values in southern California (SWC,66,12).

- BISF

BISF submitted exhibits and testimony regarding recreational uses of the San Francisco Bay area (BISF,38,T2;T,XXX,174:2-9), and identified the values of a variety of water-oriented recreational activities from the California State Parks and Recreation Department's PARIS model (BISF,38,T3). Cross-examination indicated that some of the recreational activities added into the tabulation were such that they were clearly poorly related to the flow and salinity in the Bay-Delta Estuary (T,XXX,199:17-,200:19). Although BISF did not propose flow and salinity objectives during the session on recreation, they did so in a later session (T,LVIII,236:18-240:18). It was not clear that their recommendations for flow and salinity at the later session were fully keyed to the recreational values earlier described.

- Commercial Navigation

No advocate for commercial navigation presented any testimony on flow or water quality during Phase I of the hearing. A standard exists for protection of shallow draft commercial navigation; the requirement being 5,000 cfs year-round in the Sacramento River at Wilkins Slough near the Tisdale Weir. This standard reflects historical, rather than current uses.

5.3.8.3 Optimal Level of Protection

To protect navigation in the Bay-Delta Estuary, flows in the upper reaches of the system must be sufficient to maintain the draft in Delta channels (Table 5.3.8.3-1). Recent measures taken by DWR to control salinity in south Delta channels (DWR,349,3) and structural measures to control flows in the Suisun Marsh have been in potential conflict with navigation. Features such as boat locks have been included in some (e.g., Montezuma Slough) but not all of these structures. The Montezuma Slough Control Structure includes a boat lock, but Roaring River Intake does not. If flow and salinity in the Estuary are to be controlled by structural facilities, the impacts on navigation will have to be considered, and the balance of public interest in flows, salinity and navigation addressed.

Based on a recent survey prepared for the California State Lands Commission (CSLC, May, 1986) of existing marina capacity in the general vicinity of Sacramento, 26 percent of moored boats were under 25 feet long, 65 percent were between 25 and 40 feet long, and 9 percent were over 40 feet long. This survey indicated that moored boats tended to be larger, as a class, than the entire class of boats registered in the area by the Department of Motor Vehicles. When considering total boat population, easily trailered boats (those under 21 feet long) made up about 87 percent of the total (CSLC, May, 1986). The ability of Bay-Delta channels to serve recreation and navigation is partially related to the size and draft of the boats using the channels.

Boater activity data derived from DWR studies indicate about 59 percent of the boaters' time is spent fishing, 4 percent water skiing, 36 percent general pleasure boating, and less than 1 percent sailing or jet skiing (SRRS, 1980). The season of use for boat fishing has a peak of 27.9 percent of year-round activity during April and 16.8 percent in May, and a lesser peak of 12.0 percent in October corresponding to striped bass (spring) and salmon (fall) runs. Water skiing, a year round activity, is concentrated during June, July and August, with about 85 percent of all such use occurring in these months. Cruising and general boating have nearly the same pattern. Reduced river flows and reduced channel width and depth during these seasons would affect navigation.

There is a relationship between river flow and the width of the channel, with the channel narrowing during low flow periods. During these lowered flows, there is less room to pass other boats and moored vessels, and traveling boats are required by federal law (33 USC Sec. 1006) to slow down to avoid damaging vessels and docks with their wakes. The State has adopted the federal criteria (Title 14, California Administrative Code, Section 6615) and added specific speed constraints for vessels passing within 100 feet of swimmers or 200 feet of beaches, floats, lifelines or mooring areas (Harbors and Navigation Code, Section 655.2). At extreme low water in Sacramento (approximate elevation 4 feet), channel widths are as narrow as 300 feet at some locations, compared to widths of nearly 700 feet at extreme high water (elevation 29 feet). The result is that flow affects not only depths, which will conflict with navigation by larger boats, but if low flows or structures reduce the available channel width, below 200 feet in areas where people swim, boat speeds will be constrained as well.

The flow and water surface elevation needed to prevent adverse effects on navigation will differ in each channel. As a rule, to protect recreational boating beneficial use, channels must remain open to passage. Furthermore, the water in any channel must be sufficiently deep to permit passage by any boats which ordinarily use that channel. These effects must be considered on a case-by-case basis, rather than by adopting a uniform objective.

TABLE 5.3.8.3-1
OPTIMAL LEVEL OF PROTECTION FOR NAVIGATION USE

| <u>Time</u> | <u>Location</u> | <u>Level of Protection</u> | <u>Protected</u> |
|-------------|---|---|--|
| All Year | Wilkins Slough near Tisdale Weir | 5,000 cfs | Commercial shallow draft navigation |
| All Year | All Channels | Maintain open to navigation at existing speeds by recreational watercraft on a case-by-case basis. | Recreational boating |
| All Year | Channels affected by flow control or salinity control structures | Maintain existing channel widths where over 100 feet, and with no swimming use of bank side development. Maintain existing channel widths where over 200 feet and adjacent to beaches, floats, lifelines or mooring areas. Decision to be made on a case-by-case basis. | High speed boating water skiing |

5.4 Summary

Table 5.4-1 was prepared to show the flows and water quality objectives needed in the Sacramento-San Joaquin Delta to provide optimal protection for beneficial uses such as municipal, industrial, agriculture, fish, wildlife, and wetland habitat.

Objectives for optimal protection of wetland habitat in the tidal channels of the Suisun Marsh appear in the form of electrical conductivity levels, which have been converted to approximate Delta outflows, based on a series of curves presented in DWR-57, Revised. For example, the electrical conductivity objective for February is 7.8 mmhos/cm which would be accomplished in Suisun Bay by a Delta outflow of about 17,000 cfs. Other flows and water quality objectives are introduced earlier in this chapter.

TABLE 5.4-1

OPTIMAL WATER QUALITY OBJECTIVES (Footnote 1)
FOR M & I, AGRICULTURAL, WILDLIFE, SALMON AND DELTA FISHERY USES

| Beneficial Use Protected and Location | Parameter | Description | Year Type | Dates | Values or Limit |
|---|-------------------------|--|-----------|--------------------------|-----------------|
| MUNICIPAL | | | | | |
| Contra Costa Canal at Pumping Plant #1 | Chloride | Maximum Mean Daily Chloride, mg/l | All | 1/1-12/31 | 250 |
| Clifton Court Forebay Intake at West Canal | " | " | " | " | " |
| Delta Mendota Canal at Tracy Pumping Plant | " | " | " | " | " |
| North Bay Aqueduct at Barker Slough | " | " | " | " | " |
| City of Vallejo Intake at Cache Sl. | " | " | " | " | " |
| INDUSTRIAL | | | | | |
| Contra Costa Canal Intake at Pumping Plant #1 -or- Antioch Water Works Intake on San Joaquin R. | Chloride | Maximum Mean Daily Chloride, mg/l | All | 1/1-12/31 | 150 |
| AGRICULTURE | | | | | |
| Western and Interior Delta Irrigation Sacramento R. at Emmaton | Electrical Conductivity | Maximum 14-Day Running Average Mean Daily EC, mmhos/cm | All | Dates 4/1 - 8/15 | EC 1.5 |
| San Joaquin R. at Jersey Point | | " | " | " | " |
| Mokelumne R. at Terminous | | " | " | " | " |
| San Joaquin R. at San Andreas Ldg. | | " | " | " | " |
| Cache Sl. at Junction Pt. | | " | " | " | " |
| South Delta Irrigation San Joaquin R. near Vernalis | Electrical Conductivity | Maximum 14-Day Running Average Mean Daily EC, mmhos/cm | All | 4/1 - 8/31 9/1 - 3/31 | 0.7 1.0 |
| San Joaquin R. at Mossdale | | " | " | " | " |
| Bifurcation of Old and Middle rivers | | " | " | " | " |
| Middle R. at Howard Rd. Bridge | | " | " | " | " |
| Old R. at Tracy Rd. Bridge | | " | " | " | " |
| San Joaquin R. at former site of Brandt Bridge | | " | " | " | " |
| Delta Leaching (Ponding) | | | | | |
| Emmaton Jersey Point Cache Slough at Junction Point San Andreas Landing | Electrical Conductivity | Maximum monthly average of mean daily EC, mmho/cm | All | 12/1-2/28 | 1.7 |

Footnote 1: Optimal levels of protection designed to protect beneficial uses without consideration of impact on other beneficial uses or water needs.

TABLE 5.4-1 cont'd.

OPTIMAL WATER QUALITY OBJECTIVES (Footnote 1)
FOR M & I, AGRICULTURAL, WILDLIFE, SALMON AND DELTA FISHERY USES

| Beneficial Use Protected and Location | Parameter | Description | Year Type | Dates | Values or Limit | |
|--|---|--|-----------------------------|------------|-----------------|----------|
| FISH and WILDLIFE | | | | | | |
| Suisun Marsh Wildlife Habitat Channels adjacent to brackish tidal wetlands | Electrical Conductivity, Delta Outflow (Footnote 2) | Staff estimate of salinity and flow (mmho/cm, cfs) needed to optimally protect tidal marsh habitat around Suisun Bay | All | 10/1-31 | EC | cfs |
| | | | | 11/1-12/31 | 18.8 | 6000 |
| | | | | 1/1-31 | 15.6 | 8000 |
| | | | | 2/1-3/31 | 12.5 | 10000 |
| Delta Fisheries (Sacramento R.) | | | | 4/1-7/31 | 7.8 | 17000 |
| Salmon Migration Rio Vista | Flow (Footnote 3) | Minimum daily flow (cfs) | Wet | 9/1-12/31 | 1/1-31 | 2/1-3/15 |
| | | | | 5,000 | 2,500 | 3,000 |
| | | | | 2,500 | 2,500 | 3,000 |
| | | | | 2,500 | 2,500 | 3,000 |
| | | | | 1,500 | 1,500 | 2,000 |
| Ab. Normal | 2,500 | 2,000 | 3,000 | 7/1-31 | 3,000 | 8/1-31 |
| Bl. Normal | 2,500 | 2,000 | 3,000 | 2,000 | 2,000 | 1,000 |
| Dry | 1,500 | 1,000 | 2,000 | 1,000 | 1,000 | 1,000 |
| Critical | 1,500 | 1,500 | 1,000 | 2,000 | 1,000 | 1,000 |
| Salmon Smolt Outmigration Rio Vista | Flow | Minimum daily flow (cfs) | All | 4/1-6/30 | | |
| | | | | 22,500 | | |
| Outmigrant Survival salmon, shad striped bass Delta Cross Channel | Flow Constraint | Cross Channel Gates Status of both gates | All | 4/1-11/30 | | |
| | | | | closed | | |
| Salmon Fry Rearing Delta Cross Channel | Flow Constraint | Cross Channel Gates Status of both gates | Below Normal, Dry, Critical | 1/1-3/31 | | |
| | | | | closed | | |
| Delta Fisheries (San Joaquin R.) | | | | | | |
| Adult Salmon Migration Stockton | Flow | Minimum daily flow (cfs) | All | 7/1-11/30 | | |
| | | | | 500 | | |
| Between Stockton and Turner Cut | Dissolved Oxygen | Minimum daily value (mg/L) | All | 7/1-11/30 | | |
| | | | | 6.0 | | |
| Salmon Smolt Outmigration San Joaquin R nr. Vernalis | Flow | Minimum daily flow (cfs) | All | 4/1-6/30 | | |
| | | | | 20,000 | | |
| Striped Bass Adult Migration and Spawning San Joaquin R nr. Vernalis to Antioch Bridge | Electrical Conductivity | Mean daily value not to exceed (mmho/cm) | All | 4/1-6/15 | | |
| | | | | 0.3 | | |
| Delta Fisheries | | | | | | |
| Shad Migration, Spawning and Larval Outmigration | | | | | | |
| Sacramento R at Freeport San Joaquin R nr. Vernalis | Combined Inflow Sacramento plus San Joaquin riv. | Sum of minimum daily flows not less than (cfs) (Footnote 4) | All | 4/15-11/30 | | |
| | | | | 20,000 | | |
| Shad and Striped Bass Larvae, Salmon Smolt Survival Throughout Statutory Delta | Export and Diversion | Flow permitted except in emergencies (cfs) | All | 4/1-11/30 | | |
| | | | | 0 | | |
| Striped Bass Larvae Movement to Suisun Bay Chipps Island | Delta Outflow | Minimum daily outflow (cfs) | All | 4/1-5/31 | 6/1-6/30 | 7/1-7/31 |
| | | | | 33,900 | 32,400 | 29,100 |

Footnote 1: Optimal levels of protection designed to protect beneficial uses without consideration of impact on other beneficial uses or water needs.

Footnote 2: Objective estimated to fully protect tidal wetlands of Suisun Bay including habitat of rare, threatened and endangered species.

Footnote 3: Retain Delta Plan conditions in the absence of evidence that these flows are not optimal.

Footnote 4: Proportion of San Joaquin River flow to total Delta inflow to be the same as would occur under unimpaired flow conditions (see Table 5.3.6.3-3).

5-110

References:

- California State Lands Commission, May 1986, River Marina Carrying Capacity Study, 160 pp. 5 appendices. Table 1, pg. 10, Table 14 and Appendix 1.
- California Department of Water Resources (Northern District), 1982. Sacramento River Recreation Study, 1980.



6.0 DETERMINATION OF REASONABLE NEEDS FOR CONSUMPTIVE USES OF BAY-DELTA WATERS

6.1 California Water Ethic

California's ground and surface waters are a precious, but limited resource. Water supplies, vital to homes, industry, agriculture, and fish and wildlife, while abundant in one year, can become critically limited in another. In the past, dams were built to control flooding and provide appropriate supplies during prolonged dry periods. Today the sum of water demands exceeds the reliable supply. Additional actions are required. All Californians must become involved in the reasonable use of water. All water users throughout the state will be required to participate in the task of sharing water.

6.1.1 Balancing

This Water Quality Control Plan balances the reasonable water quality and instream flow needs which protect the beneficial uses of Bay-Delta Estuary waters against the reasonable consumptive demands for Estuary water both in- and outside the watershed. These consumptive demands occur upstream in the Sacramento River Basin and San Joaquin River Basin and in export areas south and west of the Delta in the San Francisco Bay area, San Joaquin Valley and southern California. The beneficial uses in the Estuary include productive and valuable biological assets, over 1/2 million acres of fertile farm land in the Delta, and extensive wildlife habitats. The Estuary also provides water quality protection to those who divert water for use elsewhere. Because the entire state will be affected in some way by this Plan and its implementation, it has become necessary to develop a water ethic that involves all Californians.

The water ethic includes the coordination of several programs, in varying degrees, in every region of the state. Best management practices related to the use of water are needed throughout the state. Many benefits can be realized. Careful water use can decrease pollutant loadings as well as reduce water demands. The following are assumptions forming the basis of the California water ethic:

- Conservation--Municipal and industrial water users (residential, industrial and commercial) will be metered. With improved plumbing, appliances, leak detection, and landscape irrigation practices, per capita water use will be significantly reduced. All agricultural users will use water as efficiently as feasible, particularly those who contribute drainage flows to salt sinks which preclude recovery or reuse.
- Reclamation--Where feasible, water reclamation and recycling consistent with state laws shall be required to reduce the demand on existing potable water supplies. Water reclamation includes the enhanced treatment of wastewater for reuse, the conversion of saline water to freshwater, and the treatment of ground water to a sufficient level to allow subsequent beneficial use.

- Conjunctive Use--Ground water storage basins will be effectively utilized in conjunction with distribution of surface water.
- Sharing Responsibility--Adequate flows for beneficial uses in the Estuary are the responsibility of all water users in the Bay-Delta watershed.
- Physical Facilities--To better manage California's water resources, the development of physical facilities is encouraged.
- Pollution Control--~~Maximum practical pollution control~~ takes precedence over releases of freshwater for flushing flows.

6.1.2 Actions Needed

All users of Estuary waters, persons north, south and within the Estuary must share in the responsibility of meeting objectives to protect Bay-Delta beneficial uses. Also, all users should pursue the reclamation and reuse of water to its maximum potential. Water conservation and reclamation will need to be practiced in all areas, not just those south of the Estuary. Water users in the areas of water origin will also need to participate in this new water ethic.

This new water ethic forms the basis for determining reasonable consumptive water needs upstream, within, and south of the Estuary as well as water project operations which affect water flows into and through the Estuary. These changes in use of water come with associated costs. Within the limits of the available data, these costs have been considered here; additional information on this subject should be received in Phase II.

6.2 Reasonable Needs for Consumptive Uses

A review of optimal levels described in Chapter 5 shows that full protection of all beneficial uses in all water years is impossible. There simply is not enough water. Some beneficial uses have competing needs for limited supplies, and some, as noted, conflict with each other. Some accommodation has to occur. Practical application of the principles developed from the California water ethic can help identify reasonable consumptive needs for Bay-Delta water in areas upstream, within, and exported from the Estuary. These reasonable needs show that current water supplies can be managed in ways that satisfy existing and future needs. In fact, a rigorous application of the California water ethic indicates that substantial savings can be realized.

Reasonable consumptive needs are projected 2010 agricultural, municipal and industrial demands minus those potential savings achieved through water conservation and reclamation practices. Following the California water ethic, water saving methods can be used which will decrease water needs yet provide adequate supplies to support the beneficial uses made of the water.

These reasonable consumptive needs and water saving methods are discussed below. The ability to increase April through July Sacramento and San Joaquin river flows through the conjunctive use of surface and ground water and the alteration of reservoir operations are also evaluated.

6.2.1 Reasonable Consumptive Agricultural Needs

Using projected changes in demand and potential savings due to more efficient water use, projected 2010 consumptive agriculture needs in areas receiving Bay-Delta water will be about 1,007 TAF/yr less than present needs (see Table 6.2.1-1). This overall savings could be used for other beneficial uses.

The water conservation potential identified in Table 6.2.1-1 for the San Joaquin and Tulare Lake basins is based on a modification of the methodology of the Central Valley Water Use Study Committee (CVWUSC) (CVAWU, 64A). CVWUSC's methodology defines water conservation as a reduction of deep percolation losses to saline sinks, an area of about 1.7 million acres in the San Joaquin Valley (0.37 million acres in the San Joaquin Basin and 1.34 million acres in the Tulare Lake Basin). For comparison, the total irrigated acreage in the San Joaquin Valley in 1980 was 5.37 million acres (2.06 million acres in the San Joaquin Basin and 3.31 million acres in the Tulare Lake Basin (DWR, 14, 29)). The area of saline sinks includes most of the west side of the San Joaquin Valley. The total water conservation savings for this area at an Irrigation Application Efficiency (IAE) of 80 percent was considered to be about 230 TAF/yr by the CVWUSC. Instead, 550 TAF/yr is considered to be a reasonable water conservation goal at 80 percent IAE based upon the modifications to the CVWUSC methodology discussed below.

- Contribution of shallow ground water (SGC) toward meeting the evapotranspiration (ET) requirement of a crop. For areas of salt tolerant crops (only cotton and alfalfa are considered here) grown on land overlying shallow ground water, 20 percent of the ET is assumed to be satisfied by the ground water. Thus, for these areas the IAE is redefined as follows: *SURCB changes*

$$\text{IAE} = \frac{\text{ET} - \text{SGC}}{\text{Applied Water}}$$

- Analysis of net tailwater and ground water losses to the San Joaquin River, in areas draining to the San Joaquin River. The CVWUSC excluded all but 100,000 acres of the west side of the San Joaquin River from consideration for water conservation under the assumption that all losses returned to the San Joaquin River. Instead, lateral flow rates from recent studies of ground water on the west side were considered. These flow rates show that not all of the losses return to the San Joaquin River. Thus, the water conservation potential on all 345,200 acres of the west side of the San Joaquin River (DWR's Detailed Analysis Unit #216) which overlie a saline sink was evaluated.
- Assumption that the minimum leaching requirement is met by the 20 percent deep percolation which occurs at the IAE of 80 percent

TABLE 6.2.1-1

REASONABLE CONSUMPTIVE AGRICULTURAL NEEDS
(TAF/yr)

| Basin | Present (1985) | Future (2010) | Water Cons. (2010) | Reasonable Needs (2010) |
|-----------------------------|----------------------|----------------------|-----------------------|----------------------------|
| Upstream ^{1/} | | | | |
| o Sacramento | 6,338 ^{4/} | 6,505 ^{4/} | 0 | 6,505 |
| o SJ (w/o salt sinks) | 4,505 ^{4/} | 4,589 ^{4/} | 0 | 4,589 |
| Bay-Delta | | | | |
| Delta ^{1/} | 935 ^{5/} | 933 ^{6/} | 0 | 933 |
| S.F. Bay ^{2/} | 118 ^{4/} | 94 ^{4/} | 0 | 94 |
| Export ^{2/} | | | | |
| SJ (w/salt sinks) | 1,390 ^{7/} | 1,390 ^{7/} | 235 ^{7/} | 1,155 |
| Tulare Lake | 10,680 ^{4/} | 10,781 ^{4/} | 315 ^{7/} | 10,466 |
| Central Coast ^{3/} | 388 ^{8/} | 354 ^{8/} | 0 | 354 |
| S. California | 1,405 ^{7/} | 1,108 ^{7/} | 452 ^{7/} | 656 |
| TOTALS | 25,759 | 25,754 | 1,002 | 24,752 |

- 1/ Based on net water use
2/ Based on applied water use
3/ Santa Barbara and San Luis Obispo areas only
4/ From DWR, 707, Statistical Appendix; adjusted for Delta agricultural needs
5/ From DWR, 30b
6/ From DWR, 701b
7/ From staff analysis
8/ From T, XIX, 166:9-14

(assuming recycling of all tailwater). Thus, in this analysis no additional water for leaching was added to the applied water needs, as was done by the CVWUSC.

By the CVWUSC definition, the areas in the Bay-Delta watershed outside of the 0.37 million acres in the San Joaquin Basin overlying saline sinks (i.e., the rest of the upstream areas and the Delta) do not have any potential for water conservation. The losses in these areas are all considered by the CVWUSC to be recoverable and contribute to net Delta outflow. However, in the case of losses to usable ground water, the recovery of the losses usually comes at the expense of water quality degradation and a time lag. The water quality degradation occurs by dissolution of soil minerals from percolating water which over time will lead to expansion of the area of saline sinks. The time lag involved in ground water flow means that the return of the water to a river system may come at a time when additional flows are not needed. Therefore, water conservation may provide real water savings in these areas. Unfortunately, they cannot be quantified at this time. Nevertheless, since these losses in the upstream areas and the Delta are considered generally recoverable, the consumptive agricultural needs are based on net water use (i.e., crop ET). In areas not contributing to net Delta outflow, the consumptive agricultural needs are based on applied water use.

The water conservation potential identified in Table 6.2.1-1 for southern California is based on hearing testimony by Imperial Irrigation District (IID) and SWRCB's analysis assuming a goal of 80 percent IAE for Coachella Valley Water District (CVWD). Losses from IID and CVWD both go to a saline sink, the Salton Sea, and are thus irrecoverable losses. Based on hearing testimony by IID, certain projects could be undertaken which would provide a water conservation potential of up to 368 TAF/yr in IID. A combined savings of 84 TAF/yr in the CVWD and the Desert Water Agency service areas is based on increasing their IAE to 80 percent.

Although this analysis of agricultural water conservation potential is focused on saline sink areas, the goal of 80 percent IAE should be applied to all agricultural areas in California. Excessive deep percolation in nonsaline sink areas will lead to other problems; e.g., contamination of ground water with pesticides, nitrates, heavy metals, and other constituents; high ground water problems; and expansion of saline sink area through dissolution of soil mineral salts. These problems could be reduced through improved irrigation management and achievement of a 80 percent IAE.

The annual costs associated with achieving an 80 percent IAE in the west side of the San Joaquin Valley have been estimated at \$16 to \$25 per acre (EDF, 11, Executive Summary; UC Committee of Consultants on Drainage Water Reduction, 1988). Based on an analysis for the west side of the San Joaquin Valley, these costs per acre translate to between \$25 to \$40/AF of water conserved. The cost estimates for IID water conservation projects range from MWD's estimate of \$64/acre-foot of water conserved (SWRCB Order WR 88-20 p.22) to \$160 - \$275 of water conserved by IID (IID, 1987). The \$160/AF figure only includes the program items with identified water

costs
of achieve
80%
IAE

→ [savings, while the \$275/AF includes several additional programs. These cost estimates are the subject of intense negotiations.

Much of the costs of agricultural water conservation would be incurred regardless of any decision by the SWRCB on water diversions from the Bay-Delta. For example, in September 1988 the SWRCB issued Water Rights Order WR 88-20, which requires IID to submit a written plan containing definite implementation measures designed to conserve at least 100,000 AF/yr by January 1994. It also states that the SWRCB finds the conservation of 367,900 AF/yr to be a reasonable long-term goal for IID, and it will retain jurisdiction to review future water conservation measures. The costs of water conservation in IID are not likely to be borne by IID or the farmers in IID because, as noted in WR 88-20, MWD (and possibly other agencies) have expressed an interest in purchasing the water saved by conservation from IID.

Agricultural water conservation savings on the west side of the San Joaquin River may be another example of savings which would occur regardless of a SWRCB decision on water diversions from the Bay-Delta. The level of these savings will depend on the water quality objectives set for the San Joaquin River by the California Regional Water Quality Control Board, Central Valley Region early next year. As with IID, there is the possibility of financing such conservation measures by selling conserved water to other water users. This possibility has been raised in several analyses of drainage problems in the San Joaquin Valley (e.g., San Joaquin Valley Drainage Program, 1987).

6.2.2 Reasonable Consumptive Municipal and Industrial Needs

The present (1985) and projected (2010) consumptive municipal and industrial needs in areas using Bay-Delta waters are summarized in Table 6.2.2-1.

assuming reasonable needs in 2010

The totals in Table 6.2.2-1 show that despite water conservation efforts an additional 1,076 TAF/yr will be needed by 2010 to satisfy municipal and industrial demand. Much of this increased demand could be satisfied by the savings from agriculture. As with the agricultural analysis, the municipal and industrial water conservation potential in the upstream areas and the Delta is considered to be unquantifiable at this time and therefore set to zero. This is because the losses can be recoverable and generally contribute to net Delta outflow. For the municipal and industrial analysis it is assumed that losses to saline sinks in the San Joaquin Basin are minimal due to the sparse population overlying these areas. Again, for areas where return flows do not contribute to net Delta outflow, the consumptive use is based on the applied water use; for other areas, the consumptive use is based on the net water use. For example, applied water use is used for Fresno and San Francisco, while net water use is used for Sacramento and Stockton. The projected water conservation savings in the San Francisco Bay Basin and export areas are based on an aggressive water conservation and reclamation program which includes the following assumptions for 2010:

aggressive conservation assumptions in SF Bay Basin

TABLE 6.2.2-1

REASONABLE CONSUMPTIVE MUNICIPAL AND INDUSTRIAL NEEDS
(TAF/yr)

| Basin | Present (1985) | Future (2010) | Water Cons./ | |
|------------------------|---------------------|---------------------|-------------------------|----------------------------|
| | | | Recl. Savings (2010) | Reasonable Needs (2010) |
| Upstream ^{1/} | | | | |
| Sacramento | 500 ^{3/} | 679 ^{3/} | 0 | 679 |
| SJ River | 248 ^{3/} | 344 ^{3/} | 0 | 344 |
| Bay-Delta | | | | |
| Delta ^{1/} | 27 ^{4/} | 43 ^{4/} | 0 ^{4/} | 43 |
| S.F. Bay ^{2/} | 1,088 ^{3/} | 1,222 ^{3/} | 129 ^{4/} | 1,093 |
| Export ^{2/} | | | | |
| Tulare Lake | 481 ^{3/} | 729 ^{3/} | 0 | 729 |
| Central Coast | 109 ^{5/} | 136 ^{6/} | 18 ^{4/} | 118 |
| S. California | 3,609 ^{4/} | 5,221 ^{4/} | 1,089 ^{4/} | 4,132 |
| TOTALS | 6,062 | 8,374 | 1,236 | 7,138 |

1/ Based on net water use

2/ Based on applied water use

3/ From DWR, 707, Statistical Appendix; adjusted for Delta M&I needs

4/ From staff analysis

5/ From T, XIX, 166:9-14

6/ From SWC, 176, 3

SF Bay Basin
conservation
assumptions

- 95 percent compliance with the 1978 California Plumbing Code for all residences existing in 2010;
- About half of the water used by commercial and governmental/public customers is for outdoor irrigation or evaporative cooling; and
- As a result of improved irrigation efficiency and changes in landscaping practices, there will be a 20 percent reduction in existing outdoor residential, commercial and public water uses and a 40 percent reduction in new uses added between now and 2010.

Although the mix varies from agency to agency, in general the reasonable use analysis involves three areas of additional conservation: industrial use, indoor residential use, and outdoor use by residential, commercial, and public consumers. Additional conservation by industrial users is projected only for the MWD service area and the San Francisco Bay Basin, and is the smallest component of the proposed savings through conservation. This is because industrial water use in California has fallen by 50 percent or more over the past 15 years. This dramatic reduction in industrial water use is a nationwide trend that is attributable largely to enforcement of water pollution control laws. Because industrial use is now a relatively small component of total M&I use in California (about 10-13 percent), the gains from increased conservation in this component are relatively small.)

The basis for the analysis of indoor residential conservation is the 1978 California Plumbing Code which mandated lower water-using toilets and showers in new construction. Typical indoor residential water use in a nonconserving home is about 77 gallons per capita per day (gpcd), and it has been estimated that the new standards contained in the 1978 Code would reduce this by about 15.2 gpcd if fully implemented. The appliances on sale in California now meet or exceed these standards, so the only lack of implementation can arise from existing toilets or shower heads that were installed before 1978 and meet the earlier standards. By 2010 all such shower heads, and many such toilets, are likely to have been replaced. For the purposes of analyzing reasonable use, it was assumed that there would be 95 percent compliance with the 1978 Code by the year 2010, which implies an average savings of about 14.5 gpcd. Some of the projections of 2010 M&I use presented during the Phase I hearing do not appear to incorporate any savings attributable to the 1978 Code at all, while others incorporate a smaller savings (for example, a savings of 11.5 gpcd, based on an assumption of 76 percent compliance). The incremental conservation in indoor residential use in 2010 that is implied by the reasonable use analysis is the difference between 95 percent compliance with the 1978 Code and the degree of compliance assumed in individual water agencies' projections -- i.e., the difference between 14.5 gpcd and, for example, 11.5 gpcd.

In the past, much of the effort aimed by California water agencies at conservation in M&I use has focused on industrial use and indoor residential use. However, 40 percent or more of all M&I use in California is outdoor use, primarily for lawn and garden irrigation

by residential, commercial, and public-sector customers. This appears to have received relatively little attention. Whereas industrial water use has fallen by at least 50 percent over the past 15 years and indoor residential use is projected to fall by 15-25 percent by 2010 under existing conservation programs, no reduction is projected for outdoor uses. Indeed, there will probably be an increase in per-capita outdoor use by 2010 because of a trend to larger-sized lots, more development in the hotter, interior regions, and the growth of the commercial sector which appears to use significant quantities of water for outdoor irrigation and evaporative cooling. Because of the relative lack of attention, there are likely to be significant opportunities for conservation in outdoor use that have not yet been exploited. Accordingly, the third component of the reasonable use conservation analysis targets outdoor use by residential, commercial, and public consumers and proposed for 2010 reductions of 20 percent in currently existing uses and 40 percent in new uses developed between now and 2010. There is substantial evidence that such reductions are eminently feasible. DWR (1984), for example, asserts that improved irrigation practices on existing residential, commercial and governmental landscapes can reduce applied water by 20 percent, and changes in landscape design can reduce water use by 40-90 percent. Ferguson (1987) notes that even the cheapest and most primitive conservation measures can reduce urban irrigation use by 25 percent compared to a poorly designed or operated system, and argues that it is reasonable to shoot for 60-70 percent savings with more sophisticated planning and aggressive conservation measures.

In the San Francisco Bay Basin the present per capita water use is 190 gallons per capita per day (gpcd) and the 2010 water use is projected to be 179 gpcd. By applying the aggressive water conservation measures outlined above, the per capita water use in the San Francisco Bay Basin could be reduced by 19 gpcd to 160 gpcd, for a savings of 129 TAF/yr.

In the Central Coast Basin only the Santa Barbara and San Luis Obispo areas are considered in this analysis since they are the only areas planning to use Estuary water. In these areas, the aggressive water conservation and reclamation program outlined above could produce a municipal and industrial water savings of 18 TAF/yr in 2010. Based on these assumptions, M&I water use in the Santa Barbara and San Luis Obispo areas, which is currently 190 gpcd, could be reduced by 24 gpcd in 2010 from the State Water Contractors (SWC) projected level of 181 gpcd to 157 gpcd.

The major population centers in the Tulare Lake Basin, Fresno and Bakersfield, are outside of the designated saline sink area. Most of the wastewater produced in the basin is reclaimed for irrigation use. Thus, the only potential for water conservation in the Basin would be through reduced evaporation from regulating reservoirs (prior to irrigation). This amount is very small, and therefore the municipal and industrial water conservation potential is assumed to be zero.

The total water conservation and reclamation potential in the SWP service area of southern California shown in Table 6.2.2-1 is 1,089 TAF/yr in 2010. This value includes 924 TAF/yr of water conservation savings and 165 TAF/yr of increased reclamation. For Metropolitan Water District (MWD), total water conservation savings is 544 TAF/yr based on the aggressive water conservation assumptions shown earlier plus a small decrease in industrial water use. The present M&I water use in MWD is 207 gpcd. These conservation measures would reduce M&I use in the MWD service area from the 194 gpcd projected by the SWC for 2010 down to about 168 gpcd.

Water conservation savings in non-MWD areas of the SWP service area in southern California are estimated to be 380 TAF/yr. Of this total, 200 TAF/yr are based on the same reasonable use analysis as in MWD. As a result of that analysis, the non-golf course M&I use in these areas in 2010 is reduced from the level of 287 gpcd projected by SWC to about 222 gpcd. The other 180 TAF/yr represents potential savings in water use on golf courses. This savings is based on a 20 percent reduction in water usage on existing golf courses, plus an assumption that new golf course areas will increase by not more than 50 percent from 1985 to 2010, rather than the 300 percent increase assumed by the SWC.

Lastly, the increased reclamation of 165 TAF/yr is projected only for the MWD service area, and is based on data presented by MWD (SWC, 17, Table 2 and Figure 3; T, XVII, 3, 11, 69-71) identifying reclamation projects that could be developed by 2010 based on what MWD considers to be reasonable constraints on member agencies.

water conservation by industry

The primary motivating factor for additional water conservation by industry between now and 2010 will continue to be the enforcement of water pollution control regulations. This will occur regardless of any decision by the Board on water diversions from the Bay-Delta. Therefore, the incremental costs of such conservation should not be attributed to the aggressive water conservation plan described. The discussion here focuses specifically on the economic effects of conservation measures that are proposed in the analysis of reasonable use for 2010 and that go beyond those currently planned by M&I water agencies. }

There are reasons to believe that the costs associated with indoor residential conservation are likely to be modest. For example, there have recently been proposals to revise the 1978 Code to require ultra-low flush toilets and shower heads in new construction, that have been made possible by newer technologies. If fully implemented, this could reduce indoor residential use in new units by an additional 11-15 gpcd as compared to the 1978 Code "at little or no cost to customers" (EEMUD, 1988). East Bay MUD has stated that, if the State Plumbing Code were revised in this way, it would consider requiring the replacement of existing toilets and shower heads in its service area with ultra-low flush units. Also, Monterey County has recently implemented a measure mandating the installation of ultra-low flush toilets on resale of residential units. MWD has recently announced a new program of Financial Incentives for Water Conservation under which it would subsidize part of the cost to member agencies of measures such as the

installation of ultra-low flush toilet and shower head units. Such measures would more than meet the incremental indoor residential conservation implied by the reasonable use analysis.

The cost of outdoor water conservation would be greater for existing landscapes than for newly-developed landscapes. In smaller residential units without a sprinkler system, the costs of installing sprinklers or changing the landscaping can be substantial. In an efficient program, however, such users would be the last to be targeted; the initial focus would be on large commercial, public, and residential users of irrigation water. Moreover, significant savings may be obtained from existing users at relatively low cost through education and irrigation scheduling programs. Also, as noted in DWR 1984, replacing sprinkler heads and installing timers in existing sprinkler systems can be a cheap but effective way of reducing water use by 20 percent or more without harming the vegetation. Accordingly, while there will certainly be planning and management costs for water agencies administering an effective outdoor water conservation program, as well as retrofit or conversion costs for some existing users, it is believed that a well-designed program could achieve the outdoor conservation goals of the aggressive water conservation program at a reasonable cost and in an equitable manner.

The projections of increased reclamation are based on statements by the State Water Contractors about wastewater reuse projects which they intend to implement by 2010 (SWC, 17). There is no indication that the implementation of such projects would be attributable to specific actions by the SWRCB in connection with water diversions from the Bay-Delta. Therefore, these do not involve any additional economic impacts that are attributable to the aggressive water conservation and reclamation program discussed here.

It should be noted, lastly, that the reasonable use analysis assumes no reduction in population growth or new housing development from that projected for 2010 in the testimony presented during the Phase I hearing. New construction would have to incorporate more efficient plumbing fixtures and water-conserving landscaping, but all the available evidence suggests that these costs would be extremely small, both absolutely and in relation to the total price of the housing unit. Thus, no significant impacts on the housing industry are predicted as a consequence of the aggressive water conservation and reclamation program.

no pop or housing growth reduction assumed in the reasonable use analysis

6.2.3 Southern California Water Balance

The present and future water supplies and demands in southern California are summarized in Table 6.2.3-1.

The decrease in total supply shown in Table 6.2.3-1 is due to two factors: (1) the projected decrease in Colorado River supply due to the Central Arizona Project, and (2) the reduced supply from the Los Angeles Aqueduct as a result of the Mono Lake litigation. The demands shown in Table 6.2.3-1 were discussed in Tables 6.2.1-1 and 6.2.2-1. With the conservation efforts outlined previously, the

TABLE 6.2.3-1

SUPPLY AND DEMAND FOR SOUTHERN CALIFORNIA AREAS WHICH RECEIVE
STATE WATER PROJECT WATERS (IN MAF/YR)^{1/}

| | <u>Present</u> ^{2/} | <u>Future</u> ^{3/} |
|--|------------------------------|-----------------------------|
| Supply | | |
| o Local surface and ground water | 2.19 ^{4/} | 2.19 ^{4/} |
| o Colorado River | 1.47 ^{5/} | 0.80 ^{4/} |
| o State Water Project | 0.79 ^{6/} | 0.79 ^{6/} |
| o Los Angeles Aqueduct | 0.42 ^{4/} | 0.40 ^{7/} |
| o Wastewater reuse | 0.15 ^{4/} | 0.34 ^{8/} |
| o Total Supply | 5.02 ^{9/} | 4.52 |
| Demand | | |
| o Agricultural w/o conservation | 1.41 ^{10/} | 1.11 ^{10/} |
| o Agricultural w/ conservation | | 1.03 ^{11/} |
| o M&I w/o conservation | 3.61 ^{12/} | 5.22 ^{12/} |
| o M&I w/ conservation | | 4.30 ^{13/} |
| o Total Demand w/o conservation | 5.02 | 6.33 |
| o Total Demand w/ conservation | | 5.33 |
| Surplus/Deficit | 0 | -0.81 |
| Transferable water supply from agricultural water conservation in IID | | 0.37 ^{14/} |
| Transferable water supply from agricultural water conservation in SJV | | 0.34 to 0.48 ^{15/} |
| Remaining Surplus/Deficit | | -0.10 to 0.04 |

1/ - Area includes the following water districts: Antelope Valley-East Kern WA, Littlerock Creek ID, Palmdale WD, Coachella Valley WD, Desert WA, San Geronio Pass WA, Mojave WA, Crestline Lake Arrowhead WA, San Bernardino Valley WD, Castaic Lake WA, San Gabriel Valley MWD, Ventura County FCD, and Metropolitan Water District

2/ - 1985 level

3/ - 2010 level

4/ - From SWC, 4, 3

5/ - By difference

6/ - 1985 deliveries; from DWR, 1987

7/ - Estimate of reduced supply due to Mono Lake litigation

8/ - From SWC, 4, 3 plus incremental reuse identified in SWC, 17, Table 2 and

Figure 3

9/ - Set equal to demand for present

10/ - See Table 6.2.1-1

11/ - Includes conservation in CVWD only (0.08 MAF/yr)

12/ - See Table 6.2.2-1

13/ - Includes conservation only (reclamation of 0.17 MAF/yr was added to supply as wastewater reuse)

14/- Savings from the IID as discussed in Section 6.2.1

15/- 0.34 is agricultural water conservation and conveyance losses in areas supplied entirely with project water; 0.48 is agricultural water conservation and conveyance losses in areas supplied at least partially with project water (from staff analysis)

projected future (2010) demand would increase slightly, from 5.02 MAF/yr to 5.33 MAF/yr.

Despite water conservation efforts in southern California, Table 6.2.3-1 indicates that there would be a deficit of 0.82 MAF/yr in 2010. However, this deficit could probably be satisfied by transferring water savings from conservation: (1) of project water in the San Joaquin Valley, and (2) of Colorado River water in IID. The first transfer would come from increased SWP supply, but would not affect the total project exports from the Estuary.

6.2.4 Methods to Increase April through July Net Delta Outflow

The net Delta outflow could be increased in April through July by redistributing the annual inflows and/or outflows to/from the Delta. Two methods for accomplishing this seasonal redistribution of flow were evaluated:

- (1) conjunctive use of surface and ground waters; and
- (2) reoperation of Central Valley reservoirs.

These methods could be applied separately or together to provide increased April through July flows. Conjunctive use could be practiced in several upstream areas in the Sacramento and San Joaquin basins. Reoperation of reservoirs in this study entails meeting all the specific demands of reservoir operations (flood control, irrigation, fish flows) except power production. Only those releases from reservoirs which are made solely for power would be affected, since most power could still be produced within the constraints of the other operations. For example, reservoirs in the Central Valley could increase storage during August through March, while decreasing downstream flows in those months, and subsequently increase April through July discharges. However, during wetter years, reservoirs commonly reach their flood control maximum storage by December and are required to release water to maintain flood control space for spring runoff. In these cases, conjunctive use could be coordinated with reservoir reoperation to store the excess water downstream of the reservoir.

The potential for shifting August through March flows to April through July was evaluated for the San Joaquin Basin. The range would probably be from 170 TAF/yr during critically dry years to almost 700 TAF/yr during wet years. The average for the 1972-87 period over which this analysis was performed was 490 TAF/yr. Based on a percolation rate of one-third foot/day (from Kern Water Bank estimates), a spreading basin area of about 20,000 to 30,000 acres would be required, depending on whether the spreading basins are operated throughout the year on unused land or whether they are operated only during the nonirrigation season on existing farmland. Suitable sites for conjunctive use could probably be located in both the San Joaquin and Sacramento basins and in export areas.

The cost of conjunctive use in the San Joaquin Basin depends, to a great extent, on whether the operation is planned to be year-round on land purchased for spreading basins, or whether it is to be

operated only during the nonirrigation season on farmland leased for spreading purposes. In either case, the cost estimate of \$60/AF for the Kern Water Bank probably represents a good upper estimate of the costs of conjunctive use (DWR, 1986). The costs in the San Joaquin Basin, however, would probably be somewhat less than the Kern Water Bank due to two advantages of the San Joaquin Basin location: (1) more extensive existing water distribution systems, and (2) shallower depth to ground water. The cost of reservoir reoperation, probably about \$15/AF, would primarily be the lost power revenue created by shifting the time of reservoir releases from August through March to April through July.

REFERENCES

- California Department of Water Resources. 1984. Water Conservation in California. Bulletin 198-84, July 1984.
- California Department of Water Resources. 1986. Final Environmental Impact Report - Artificial Recharge, Storage and Overdraft Correction Program, Kern County, California (Kern Water Bank). December 1986, p. 34.
- California Department of Water Resources. 1987. Management of the California State Water Project. Bulletin 132-87, September 1987.
- East Bay MUD. 1988. Water Supply Management Program Technical Report & Appendices. Oakland, September 1988.
- Ferguson, Bruce K. 1987. Water Conservation Methods in Urban Landscape Irrigation: An Exploratory Overview. Water Resources Bulletin, 23: 147-152.
- Imperial Irrigation District. 1987. Water Conservation Program, Implementation Plan. Exhibit 25 for SWRCB hearing, March 1988.
- San Joaquin Valley Drainage Program. 1987. Farm Water Management Options for Drainage Reduction. Agricultural Water Management Subcommittee, October 1987.
- University of California Committee of Consultants on Drainage Water Reduction. 1988. Associated Costs of Drainage Water Reduction. No. 2 in Series on Drainage, Salinity and Toxic Constituents, January 1988.

7.0 WATER QUALITY OBJECTIVES

7.1 Introduction

Chapter 5 identifies the optimal levels of protection for the beneficial uses of Bay-Delta waters. A review of these conflicting needs indicates that the watershed of the Bay-Delta Estuary does not possess enough water to satisfy all these demands except possibly in the wettest of years. Therefore, each of these demands must be reevaluated in light of the reasonableness to satisfy them. The concept of the California water ethic was presented in Chapter 6 to establish some ground rules to assess the reasonableness of water use. Chapter 6 also evaluates the reasonable needs of Bay-Delta water supplies for areas upstream and downstream of the Bay-Delta Estuary. Chapter 7 will present the information used to evaluate the reasonableness of instream flow and salinity objectives to protect the beneficial uses of Estuary water.

This chapter begins with an evaluation of each beneficial use and alternative levels of protection for each use. These alternatives were evaluated in light of the water ethic principles discussed in Chapter 6. The pertinent principles for this discussion are:

- Municipal and industrial water users should receive salinity protection of at least the secondary public health standard of 250 mg/l chloride.
- Delta agricultural users should receive water quality that fully protects their needs assuming that best management practices are being employed, to the extent that such quality was available under unimpaired conditions with present day channel configurations (see Cal. Const., Art X, Sec. 2).
- Aquatic life in the Estuary should receive salinity and flows at an appropriate historic level. The appropriate historic level is established during the balancing process as subsequently explained. (See Water Code Section 1243; Public Resources Code Section 21000, et seq.; State Board Resolution 68-16).

Once the alternative levels of protection for each beneficial use are determined, they are assembled into logical sets of alternative water quality objectives. Six alternative sets of objectives were developed and evaluated. The effects of each of these six sets of alternative water quality objectives on beneficial uses in the Estuary and the water supply and use community were assessed. Through the careful weighing of these effects a set of recommended water quality objectives is proposed.

7.2 Alternative Levels of Protection for Each Beneficial Use

This section presents the analysis of reasonable alternative levels of protection for each beneficial use in the Bay-Delta Estuary consistent with the water ethic (see Chapter 6).

7.2.1 Municipal and Industrial

As presented in Chapter 5, there are five major municipal and industrial water supply intakes in the Estuary. Water customers

demand the best possible water quality they can obtain. However, what users would like to have and what is reasonable, when all competing demands are considered, are often very different.

Two major water quality issues were brought out during the Phase I hearing. The first deals with trihalomethanes and the second involves salinity.

7.2.1.1 Trihalomethanes

Trihalomethanes are known carcinogens that can be produced during some water treatment processes, such as chlorination, designed to purify water for drinking. Trihalomethanes are generated in higher concentrations when the source water contains high concentrations of two important precursors, organic compounds and halides, e.g., chlorides and bromides such as those found in sea water. Since the Delta contains significant amounts of organic soil formed when it was an inland marsh and since it is located near the ocean, the Delta contains ample quantities of both chlorides, bromides and organic materials.

Some hearing participants suggested that fresh water be used to flush chlorides and bromides away from municipal intakes. Others suggested that extensive agricultural drainage systems be installed to remove this unquantified portion of organic loading to locations far downstream of municipal intakes. Both of these proposals could reduce trihalomethane precursors. However, they will not guarantee that concerns over the formation of trihalomethanes will be resolved. Even water quality in the Sacramento River at the City of Sacramento will not attain the trihalomethane standard if it is lowered (from 100 mg/l to 50 mg/l or less as EPA is considering) and the water is treated through routine chlorination.

Based on the evidence presented during the Phase I of the hearing, the trihalomethane issue in the Delta is considered a water supply treatment issue. The establishment of reasonable water quality objectives in the Estuary will not resolve the issues surrounding the formation of trihalomethanes in the water supply treatment process. Technology currently exists for water purveyors who obtain water from the Estuary to treat their supplies (as does the Contra Costa Water District) without forming excessive trihalomethanes and other compounds.

7.2.1.2 Salinity

- Chlorides

Salinity in drinking water can cause two types of concerns: taste and increased industrial processing costs due to high chloride levels.

High chloride levels can impart an unpleasant taste to drinking water. All else being equal, most users would rather drink low salinity water than water with a slight salty taste. The Department of Health Services has recognized this

and adopted a secondary drinking water standard of 250 mg/l for chlorides. This level of chlorides protects the public interest.

Groups of water users have expended funds to build projects to achieve water quality better than 250 mg/l chloride. These projects include diverting higher up on a water course, or the construction of storage facilities to store low saline water during the winter for dilution of saltier summer supplies. Such actions are local issues and are appropriate provided statewide interests are not unreasonably impaired.

In the 1978 Delta Plan, the Board developed water quality objectives for the Contra Costa Canal intake at Rock Slough for chloride levels of 150 mg/l for various times during the year, depending on the wetness of that year. This objective was intended to protect the historical water supply of two paper manufacturing industries.

Other industrial uses are reasonably protected at the 250 mg/l chloride objective. Some industries use special treatment processes to remove either salinity or other constituents that can affect their operations. However, such special processing is a matter for these industries to resolve with their water purveyor and not a matter of overriding statewide public interest. Therefore, the 150 mg/l chloride objective should be discontinued. The 250 mg/l chloride objective provides reasonable protection to municipal and industrial uses. It is used in each set of objectives presented in the next section to protect municipal and industrial beneficial uses.

- Sodium

A relatively new issue related to salinity involves the consumption of sodium. Diets high in sodium, especially for people with a history of heart problems, can contribute to heart problems. Some participants in the hearing suggested a sodium objective be adopted to protect against such concerns. Others were concerned about the effects of high sodium water on dialysis machines. The information presented to the Board shows that sodium contained in drinking water represents a very small portion of normal daily sodium intake. People on very restricted sodium diets should consult their physician and dietitian to revise their diet based on their local water supply or in very rare cases consider bottled water low in sodium. Concerns with dialysis machine operations can be resolved by switching to other lower saline sources when sodium levels become a problem.

Concerns raised, related to sodium, do not warrant the adoption of specific sodium water quality objectives. This concern can be reasonably resolved by achieving the 250 mg/l chloride objective in Delta waters or special actions by

health professionals as they become more knowledgeable of the sodium levels in their water supply.

7.2.2 Agriculture

7.2.2.1 Western and Interior Delta Agriculture

Chapters 4 and 5 review the testimony presented during Phase I on the water quality needs of the mostly organic soils found in the western and interior Delta. Following the adoption of the 1978 Delta Plan, studies were designed to resolve concerns expressed by the Board on the lack of specific information about the needs of salt sensitive crops when grown using subirrigation on the Delta's rich organic soils. The results of this study show that corn (the most salt sensitive significant crop grown in the western and interior Delta) can be grown with no yield decrement in salinities that do not exceed 1.5 mmhos/cm EC during the growing season (April 1 through August 15). This assumes periodic leaching with water quality at least as good as 1.7 mmhos/cm EC during some winters.

One of the principles in the water ethic is that agricultural users should receive water quality to protect their reasonable needs as limited by the availability of this quality water under unimpaired water runoff conditions. Achievement of this level of water quality would protect this beneficial use to the extent it would have been protected if man's activities to modify river flows had not taken place. The level of salinities that would occur in these western Delta areas under these unimpaired water runoff conditions were reviewed. This review indicated that water qualities as good as 1.5 mmhos/cm EC occurred throughout the growing season except in the latter part of critically dry years. In order to reflect the water quality available under unimpaired conditions in critical years, values should be allowed to rise from 1.5 to 3.0 mmhos/cm EC beginning August 1 and remain no higher than that level through the end of the growing season (August 15). These salinity levels are appropriate to protect agriculture in the western and interior Delta. These proposed objectives along with leaching water requirements are used in each alternative set of objectives presented in the next section as the water quality objectives to protect western and interior Delta agriculture beneficial uses.

7.2.2.2 Southern Delta Agriculture

Water quality in the San Joaquin River as it enters the southern Delta near Vernalis has degraded in the last 50 years. Average salt concentrations have more than doubled during this period. This degradation is caused by a combination of two factors: increased salt loadings from upstream agricultural drainage and decreased flows, caused by upstream water development, that helped dilute high saline water.

In the 1978 Delta Plan, the Board adopted water quality objectives to protect southern Delta agriculture on the mineral soils in this area. These objectives differ from those set for

the predominately organic soils found in the western and interior Delta. The Board delayed implementation of these objectives to allow interested parties time to negotiate a long-term agreement to achieve these objectives. While some progress has been made in this area, it has been too slow and decisive action is needed.

The 1978 Delta Plan objectives for the southern Delta have been reviewed in light of the testimony presented in the Phase I of the hearing. Beans, a salt sensitive crop, are grown in significant quantities in the southern Delta. With best management practices by the southern Delta farmers, the current Delta Plan objectives protect this and other crops grown during the primary irrigation season (April through August) and other less salt sensitive crops, e.g., alfalfa and sugar beets, grown during the remainder of the year.

However, two aspects of these objectives need review. First, the mean monthly monitoring frequency contained in the Delta Plan is too long, as explained by the South Delta Water Agency, and should be reduced to a 14-day running average consistent with western and interior Delta objectives. Second, the objectives need to be tested to see if they would be attained during unimpaired flow conditions. This analysis indicates that the 0.7 mmhos/cm EC set forth in the objectives during the primary irrigation season of April through August generally would be available under unimpaired runoff conditions during all water year types. This analysis used water quality to flow relationships for the San Joaquin River that existed prior to 1945 (SDWA Exhibit 123 and New Melones Hearing USBR Exhibit 43).

During the secondary irrigation season, September through March, the 1.0 mmhos/cm EC provides water quality sufficient to protect crops irrigated during this time of year, e.g., alfalfa, pasture and sugar beets. This quality protects the seedling stages of these crops and is sufficient for winter leaching. Also, analysis shows that 1.0 mmhos/cm EC generally would be achieved during these months under unimpaired runoff conditions. These objectives are used for each set of water quality objectives and are shown in detail in the recommended objectives presented later in this chapter.

7.2.2.3 Export Areas

Substantial quantities of water are exported from the Delta for use in areas outside the Delta. The locations of these diversions are the same as the municipal and industrial diversions discussed previously. The water quality objectives that protect drinking water supplies at these locations (250 mg/l chloride) also reasonably protect agricultural uses of water for irrigation of the crops grown in the Central Valley and southern California.

The SWP contractors have water supply contracts that have a goal of delivering water with a quality of 110 mg/l chloride. This delivered quality is achieved by blending good quality water

diverted in the winter with the more saline water diverted during the summer. At times the SWP also allocates a portion of its water supply to improve water quality to approximately 100 mg/l chloride at Clifton Court. This "carriage water" requirement increases as exports increase during the summer. As much as one-third more water beyond that needed for export may be required to repulse sea water in some months. The water supply impact analysis discussed in Section 7.3.1 assumes a maximum 250 mg/l chloride level at SWP water supply intakes. The users may choose to allocate a portion of their limited supply to further improve the quality of exported water.

7.2.3 Delta Fisheries and Estuarine Habitat

There are two water project related effects on Delta fisheries. They are (1) River inflow and Delta outflow, which moves Delta fish downstream into the more biologically productive Suisun and San Pablo bays and away from the effects of the state and federal export pumps and other Delta diversions and (2) exports, which physically entrain fish, lead to increased predation, move fish into less biologically productive areas and generally decrease productivity of the Delta environment by increasing cross Delta flows.

7.2.3.1 Chinook Salmon

- Flow

As discussed in Chapters 4 and 5, evidence was presented showing that April through June inflows to the Delta affect the quality and quantity of fishery habitat, smolt survival during outmigration, and subsequent escapement of fall run Chinook salmon 2 1/2 years later. The Sacramento Basin produces up to 90 percent of Central Valley salmon. Since counts were first made in the 1950's, the natural salmon population has declined by an estimated 75 percent. In the last 20 years, although the natural population has continued to decline, an increase in hatchery produced fish has stabilized the total Sacramento Basin population (see Figure 4.5.1.2-4). This is achieved by releasing many hatchery reared fish downstream of the Delta, thus avoiding the poor environmental conditions in the Delta.

San Joaquin River salmon populations fluctuate markedly, partly in response to spring flow conditions, and range from less than one to 26 percent of the Central Valley salmon population. There are three other races of Chinook salmon in the Sacramento River, two of which have also experienced population declines since the late 1960's. One race was eliminated from the San Joaquin Basin by the construction of Friant Dam. Sufficient evidence was presented in the Phase I Hearing to determine Delta protections needed for the fall run salmon but not the other races of Chinook salmon on the San Joaquin or Sacramento River systems.

Available data indicate that river flows in April through June up to a certain limit (22,500 cfs on the Sacramento River at

Rio Vista and 20,000 cfs on the San Joaquin River at Vernalis) provide benefits to salmon migration. These benefits are linearly related to increasing Sacramento River flows. Limited data from the San Joaquin indicate a similar relationship.

In addition to the optimal level and the no action level, three alternative levels of salmon protection with different Delta inflow regimes were developed. One of the principles developed under the water ethic states that aquatic resources should receive protection equivalent to that received over some recent historical period. The alternatives presented below represent a range of historical periods and are evaluated later in this chapter to determine a reasonable level of protection for Chinook salmon. The alternatives are:

- (1) Optimal protection - April through June average monthly flows of 22,500 cfs at Rio Vista on the Sacramento River and 20,000 cfs at Vernalis on the San Joaquin River.
- (2) Average April through June flows in the Delta generally reflecting those prior to physical modifications to enhance water deliveries south of the Delta (1930-1952). The year 1930 represents the earliest year of flow data available for key interior Delta locations. Some modification to the actual historical value for each year type was made by decreasing wet year flows and increasing drier year flows as has been experienced in recent years.
- (3) Average April through June flows for the entire period for which reliable data exist at key interior Delta locations (1930-1987).
- (4) Average April through June flows which have occurred under the present physical configuration of the Delta (1953-1987).
- (5) Flows as set forth in the 1978 Delta Plan for salmon.

The average April through June flows for the above alternatives are shown in Table 7.2.3.1-1. They are shown as averages for each month and are separated by water year type. These monthly average flows excluded flows that were above 22,500 on the Sacramento River at Rio Vista and 20,000 on the San Joaquin at Vernalis. Flows above these values were not included because there is no clear evidence that flows in excess of these amounts benefit salmon migration through the Delta. Figure 7.2.3.1-1 summarizes in graphic form how average April through June flows important to salmon have changed over various time periods and are expected to change in the future.

The USFWS and the DFG recommended the establishment of average Delta inflows generally reflective of conditions prior to 1950. The SWP contractors and others recommended maintenance of the 1978 Delta Plan fishery flows into the

TABLE 7.2.3.1-1

ALTERNATIVE LEVELS OF PROTECTION
FOR SACRAMENTO AND SAN JOAQUIN SALMON OUTMIGRATION

| Beneficial Use Protected and Location | Parameter | Description | Year Type | Values | | | | | | | |
|---|---|--|------------|-------------------------|----------------------------|-------------------------|----------------------------|-------------------------|----------------------------|---|-------|
| | | | | Dates/ CFS 4/1-30 | Cross Channel Status | Dates/ CFS 5/1-31 | Cross Channel Status | Dates/ CFS 6/1-30 | Cross Channel Status | | |
| FISH HABITAT | | | | | | | | | | | |
| o Sacramento Salmon Rio Vista 1930-1952 | Flow at Rio Vista and Cross-Channel status. (see Footnote) | Flow pattern estimated to provide protection found from 1930-52, plus Cross-Channel closures to prevent smolt diversion | Wet | 22,500 | C | 22,500 | C | 21,500 | C | | |
| | | | Ab. Normal | 22,500 | C | 22,500 | C | 12,000 | C | | |
| | | | Bl. Normal | 20,500 | C | 21,000 | C | 8,000 | C | | |
| | | | Dry | 20,500 | C | 16,000 | C | 9,500 | C | | |
| o San Joaquin River Salmon Vernalis 1930-1952 | Vernalis Flow | Flow pattern estimated to provide protection found from 1930-52 | Wet | 17,000 | | 19,000 | | 19,000 | | | |
| | | | Ab. Normal | 12,000 | | 14,500 | | 11,500 | | | |
| | | | Bl. Normal | 2,500 | | 4,000 | | 4,500 | | | |
| | | | Dry | 1,500 | | 2,000 | | 1,000 | | | |
| o Sacramento Salmon Rio Vista 1930-1987 | Flow at Rio Vista and Cross-Channel status . | Flow pattern estimated to provide protection found from 1930-87 | Wet | 22,500 | C | 22,000 | C | 17,000 | C | | |
| | | | Ab. Normal | 22,500 | C | 21,000 | C | 7,000 | C | | |
| | | | Bl. Normal | 16,500 | C | 14,500 | C | 7,500 | C | | |
| | | | Dry | 12,500 | C | 10,000 | C | 5,000 | C | | |
| o San Joaquin River Salmon Vernalis 1930-1987 | Vernalis Flow | Flow pattern estimated to provide protection found from 1930-87 | Wet | 15,000 | | 15,500 | | 13,500 | | | |
| | | | Ab. Normal | 9,000 | | 11,000 | | 9,000 | | | |
| | | | Bl. Normal | 2,500 | | 3,500 | | 3,500 | | | |
| | | | Dry | 1,500 | | 1,500 | | 1,000 | | | |
| o Sacramento Salmon Rio Vista 1953-1987 | Flow at Rio Vista and Cross-Channel status. | Flow pattern estimated to provide protection comparable to that from 1953 to 1987, plus Cross-Channel closures to prevent some smolt diversion | Wet | 22,500 | C | 22,000 | C | 17,000 | C | | |
| | | | Ab. Normal | 22,500 | C | 17,000 | C | 7,000 | C1 | | |
| | | | Bl. Normal | 14,000 | C | 11,500 | C | 7,500 | C1 | | |
| | | | Dry | 8,000 | C | 7,000 | C1 | 5,000 | C1 | | |
| o San Joaquin River Salmon Vernalis 1953-1987 | Vernalis Flow | Flow pattern estimated to provide protection comparable to that from 1953-87 @ Vernalis (During buildup of SWP & CVP) | Wet | 14,000 | | 13,500 | | 11,000 | | | |
| | | | Ab. Normal | 5,000 | | 5,000 | | 5,000 | | | |
| | | | Bl. Normal | 2,500 | | 3,500 | | 3,000 | | | |
| | | | Dry | 1,500 | | 1,500 | | 1,000 | | | |
| o Sacramento Salmon Rio Vista Delta Plan | Delta Outflow | Delta Plan had no specific protection for Salmon smolts but other standards provided protection as indicated | Wet | 10,000 | O | 13,350 | C | 8,000 | 14,000 | C | 7,600 |
| | | | Ab. Normal | 7,600 | O | 12,950 | C | 7,600 | 10,700 | O | 7,600 |
| | | | Bl. Normal | 7,600 | O | 10,800 | C | 7,600 | 9,500 | O | 6,850 |
| | | | Dry | 7,600 | O | 7,600 | O | | 6,150 | O | |
| o San Joaquin River Salmon Vernalis Delta Plan | Vernalis Flow | Delta Plan had no specific protection for Salmon smolts | Wet | 6,700 | O | 4,350 | O | | 3,900 | O | |
| | | | Ab. Normal | | | | | | | | |
| | | | Bl. Normal | | | | | | | | |
| | | | Dry | | | | | | | | |

Footnote: C = closed, C1 = closed, open weekends only, O = open

7-8

FIGURE 7.2.3.1-1 Average April-June flows¹ for selected historical periods providing different levels of protection for Salmon

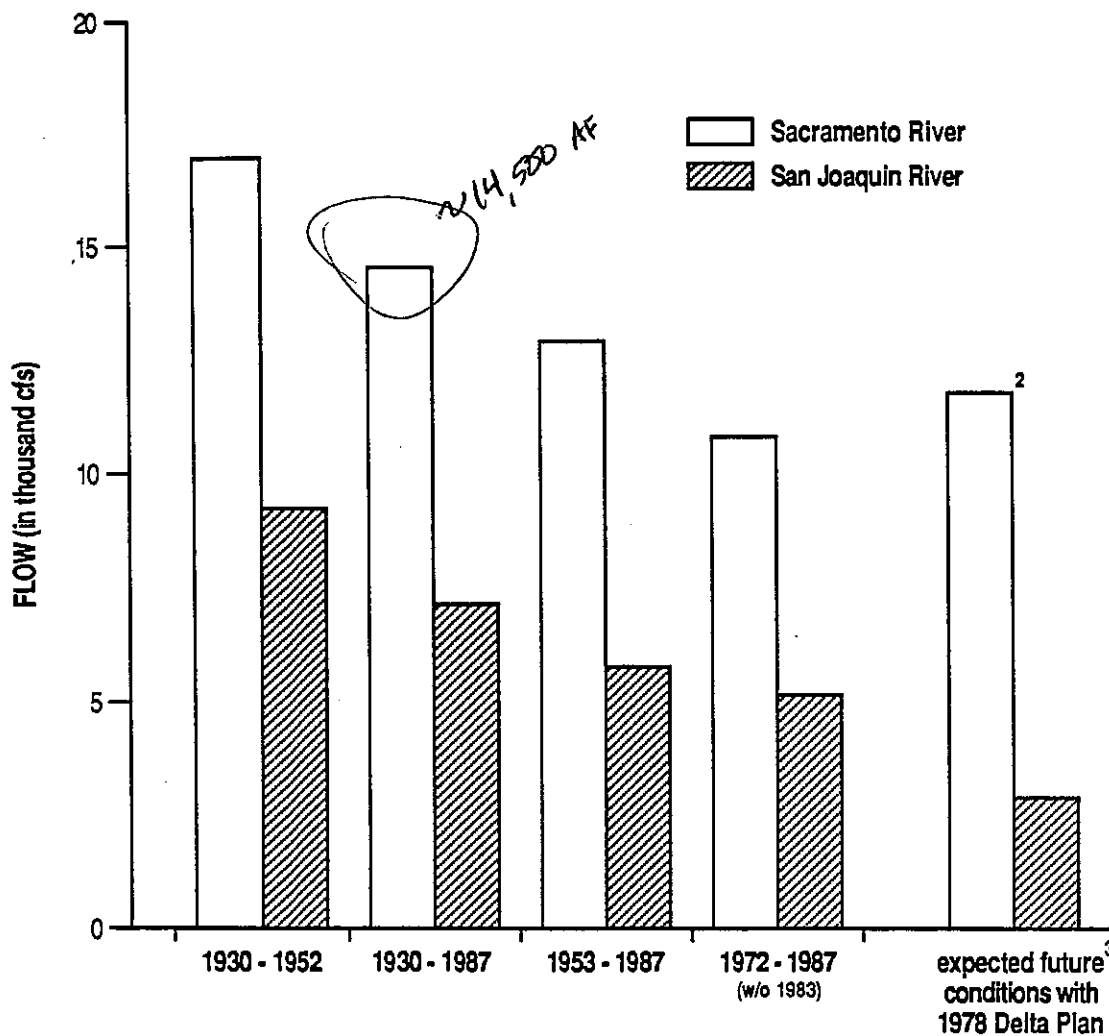

¹ Average monthly flows calculated with a maximum Sacramento River flows at Rio Vista of 22,500 cfs and maximum San Joaquin River flows at Vernalis of 20,000 cfs because maximum salmon survival/production was shown by USFWS and DFG to occur at these flows. Therefore, it is assumed there is no additional benefit to fisheries at flows exceeding these values.

² The apparent increase in Sacramento River flows over the 1972 - 1987 period is due to the fact that the average April-July runoff for the 1922 - 1978 hydrology used to calculate the expected flows is 14% wetter than the 1972 - 1987 period for the Sacramento River Basin. Average unimpaired runoff for both time periods on the San Joaquin system are within 1% of each other.

³ Expected future conditions with the 1978 Delta Plan are those shown in DWR's 1990 Level of Development operations study using 1922-78 hydrology (DWR, 30)

future. As can be seen from Figure 7.2.3.1-1, continuation of the existing flow objectives in the Delta Plan (which do not specifically protect salmon outmigration) will result in a relative decline in important salmon smolt flows on the San Joaquin River system when compared with flows experienced in the recent past. The apparent increase in Sacramento River flows under expected future conditions is due to the fact that the 1922-78 period used in this analysis is 14 percent wetter on the Sacramento system than the 1972-1987 period. The two hydrologic periods on the San Joaquin system, however, are essentially the same (less than one percent difference). Some hearing participants recommended that activities outside the Estuary be tried to resolve salmon survival concerns. Activities such as upstream habitat improvements might be successful on the Sacramento River system given the small expected decrease in spring flows under the no action alternative. However, it is unlikely that such actions would be successful on the San Joaquin River system with the decrease in April-June flows expected in the future.

Some parties suggested that additional fishery catch restrictions or other activities outside the scope of the Board's authority be pursued to address salmon concerns. While the option exists to take no action related to the further regulation of flows and exports, it is not reasonable to rely on "out of Estuary" measures to correct habitat concerns related to factors in the Estuary. To do so would be to have one segment of society mitigate for the effects not caused by their actions. Furthermore, fishery agencies testified that "out of Estuary" restrictions would have relatively little beneficial effect if smolts migrating through the Delta continued to experience poor conditions within the Delta.

Moderate flows are also needed for homing by adults during the upstream spawning migration from July-December. The 1978 Delta Plan contains minimum flow objectives for upstream salmon migration in the Sacramento River. These objectives were developed before the recent information on outmigrant smolts was known. In the absence of evidence to the contrary, these flows are assumed to be adequate and should be retained.

Currently there are no requirements for minimum upstream flows on the San Joaquin River for upstream salmon migration. Low dissolved oxygen at Stockton may also cause a blockage to upstream salmon passage. A 1969 agreement between DWR, USBR, and DFG provided for 1) installation of a temporary barrier across Old River when dissolved oxygen (DO) falls below 6 mg/l so that flows increase down the San Joaquin River, or 2) if that is not successful, increased flow releases. This objective should be incorporated in this Plan.

- Exports and Diversions

Salmon smolt migration through the Estuary is also affected directly by diversions and exports and indirectly by flow reversals caused by exports. Since 1967, export rates from the Estuary have increased over this same period while salmon populations have declined (see Figure 7.2.3.1-2). Alternatives to address these fishery impacts are discussed in the section below.

7.2.3.2 Striped Bass

- Outflow

Striped bass have undergone a decline in the numbers of young that survive their first summer. A gradual decline began soon after the start of operation of the SWP in 1967 and became precipitous in the late 1970's. This decline is shown on Figure 7.2.3.1-2. The exact cause for this decline is unknown. However, five causes have been postulated, of which four relate to water project operations and one relates to pollutants. The Board's Striped Bass Health Monitoring Program has indicated that the burdens of various pollutants in adult striped bass, and the percentage of egg resorption, have both improved in recent years. Yet the numbers of young striped bass, as measured by the striped bass index, continue to decline.

Outflows move the striped bass larvae (and young of American shad, salmon, etc.) out of the Delta and away from the influence of export pumps, diversions and power plants, and into the Suisun Bay nursery areas. A relationship of spring flow and exports to young bass populations in the summer was developed from data collected during the mid-1950's to the mid-1970's. However, in recent years, exports have increased beyond those for which this relationship was developed. Therefore, it is not surprising that this historic relationship no longer holds true. Higher outflows and reduced exports appear to be needed to help reverse this recent decline.

- Alternative Levels of Protection

New Delta outflow objectives for striped bass were recommended by DFG, USFWS and others. These agency recommendations are shown in Table 7.2.3.2-1. The dry water year following a dry or critical water year relaxation proposed by DFG has been deleted from that shown in Table 7.2.3.2-1 for the following reasons: (1) the year type definitions discussed previously now closely reflect April-July runoff conditions; (2) the year type definition already has a year after critical year relaxation built into it; and (3) recent project operations indicate that, while fishery standards are greatly relaxed in critical years, project operations are not modified commensurate to the fishery relaxation; operations, in fact, use the relaxation to

FIGURE 7.2.3.1-2

STRIPED BASS INDEX, SACRAMENTO/SAN JOAQUIN NATURAL SALMON POPULATION AND TOTAL DELTA EXPORTS

SBI: 1959 - 1988, EXCEPT 1966; POPULATION: SR 1953 - 1984, SJR 1953 - 1984; EXPORTS: AVERAGE APRIL - JULY EXPORTS, 1953 - 1987
(5 Year Running Average)

7-12

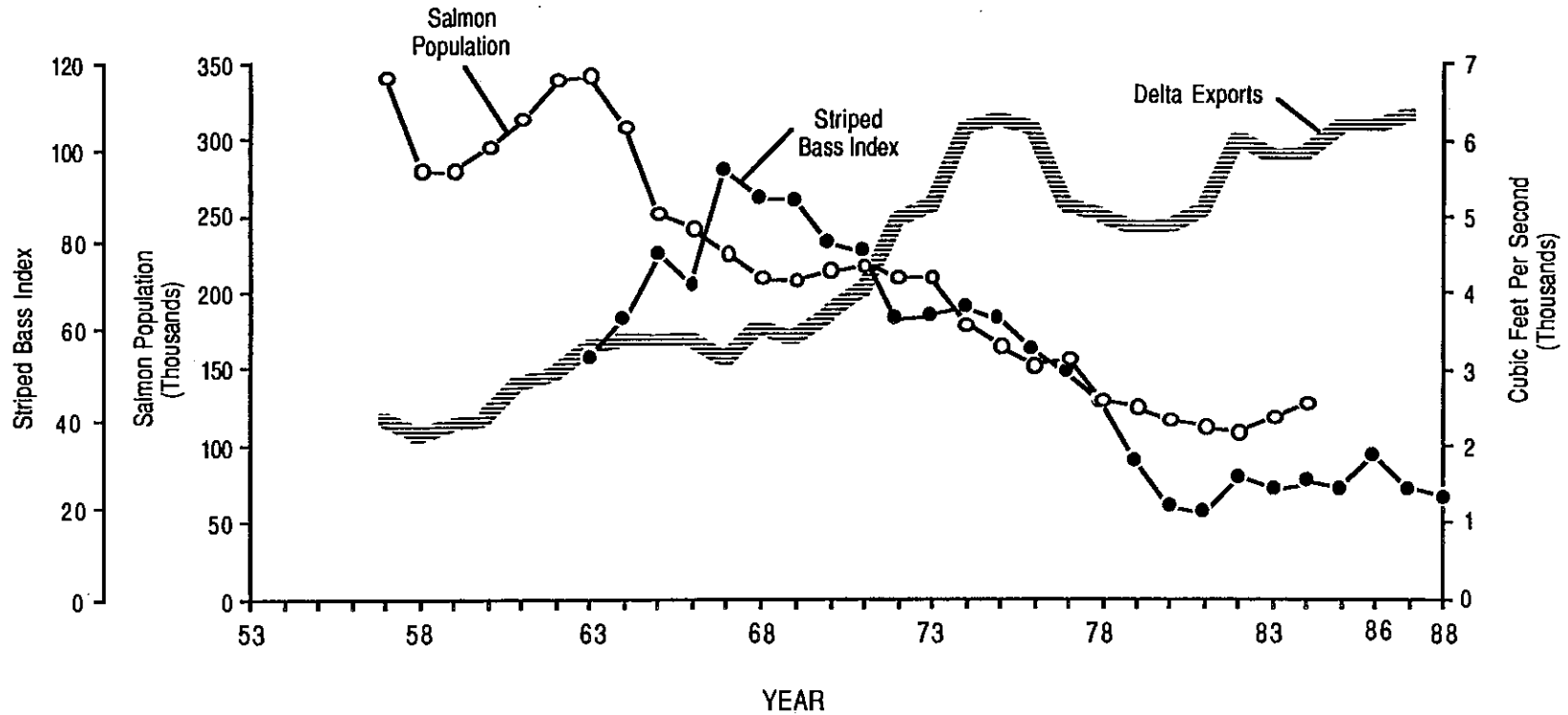

TABLE 7.2.3.2-1

ALTERNATIVE LEVELS OF PROTECTION
FOR DELTA FISHERIES (INCLUDING STRIPED BASS)
VIA DELTA OUTFLOW

| Beneficial Use Protected and Method | Parameter | Description | Year Type | Values | | | | |
|---|--|---|-------------|--------|----------|--------|---------|-----------|
| FISH HABITAT | | | | 4/1-30 | 5/1-31 | 6/1-30 | 7/1-15 | 7/16-31 |
| o Delta Outflow Staff Recommendation | Mean Monthly Delta Outflow at Chipps Is. | Habitat quality to provide egg and larval transport through Delta and maintain suitable habitat for rearing in Suisun Bay. | Wet | 32400 | 32400 | 32400 | 29000 | 29000 |
| | | | Ab. Normal | 26000 | 26000 | 20000 | 15000 | 15000 |
| | | | Bl. Normal | 22000 | 22000 | 16000 | 10000 | NA |
| | | | Dry | 12000 | 12000 | 12000 | 10000 | NA |
| | | | Critical | 9600 | 9600 | 9600 | NA | NA |
| | | | | 4/1-30 | 5/1-31 | 6/1-10 | 6/11-17 | 6/18-7/31 |
| o Delta Outflow DFG-USFWS Recommendation | Mean Monthly Delta Outflow at Chipps Is. | Habitat quality to provide egg and larval transport through Delta and maintain suitable habitat for rearing in Suisun Bay. | Wet | NA | 30000 | 30000 | 20000 | 10000 |
| | | | Ab. Normal | NA | 25000 | 25000 | 17500 | 10000 |
| | | | Bl. Normal | NA | 22000 | 22000 | 16000 | 10000 |
| | | | Dry | NA | 12000 | 12000 | 10000 | 8000 |
| | | | Critical | NA | 3300 | 3300 | 3100 | 2900 |
| | | | | 4/1-14 | 4/15-5/5 | 5/6-31 | 6/1-30 | 7/1-31 |
| o Delta Outflow with limits from 1978 Delta Plan | Mean Monthly Delta Outflow at Chipps Is. | Habitat quality to provide egg and larval transport through Delta and maintain suitable habitat for rearing in Suisun Bay (includes EC at Antioch of 1.5 mmho/cm for spawning 4/15-5/5) | Wet | 6700 | 7600 | 14000 | 14000 | 10000 |
| | | | Ab. Normal | 6700 | 7600 | 14000 | 10700 | 7700 |
| | | | Bl. Normal | 6700 | 7600 | 11400 | 9500 | 6500 |
| | | | Dry | 6700 | 7600 | 4300 | 3600 | 3200 |
| | | | Critical | 6700 | 7600 | 3300 | 3100 | 2900 |
| | | | Dry & defic | | | 3300 | 3100 | 2900 |

7-13

continue to meet full project demands. Therefore, such relaxation terms should be used only sparingly.

Upon review of the basic data presented on striped bass during the Phase I hearing, an alternative set of objectives has been proposed for consideration. This alternative set provides protection in April and increases critical year protection compared to DFG proposed levels. These values are shown in Table 7.2.3.2-1. Also shown in this Table are the 1978 Delta Plan flow objectives for striped bass.

- Export Flows

→ (An integral factor affecting Delta fisheries is the exports from the CVP Tracy Pumping Plant and the SWP Banks Pumping Plant which can create flow reversals the lower San Joaquin, Old and Middle rivers. Appropriate limits on these large diversions are the subject of much debate. Fishery agencies and other interested parties recommended that, in the long term, improvement of the fisheries would result from positive downstream flows in Old and Middle rivers during the spring months. Such positive downstream flows result when San Joaquin River flows exceed exports and channel depletions in the southern Delta. Therefore, export rates that will achieve positive downstream flows must be matched month by month with the San Joaquin River inflows and channel depletions if the goal of positive downstream flows is to be achieved.

- Alternative Levels of Protection

Four alternative export water quality objectives have been developed for the April through July period. They are:

- (1) Positive downstream flow in Old and Middle rivers by coordinating export levels with high San Joaquin River inflows resulting from the 1930-1952 flow objectives;
- (2) Positive downstream flow in Old and Middle rivers by coordinating export levels with low San Joaquin River inflows resulting from 1953-1987 flow objectives;
- (3) Average pre-SWP export conditions (1953-1967); and
- (4) 1978 Delta Plan export limits.

All of these objectives are shown in Table 7.2.3.2-2. The first alternative evaluated the export rates that would allow positive downstream flows (about 500 cfs) in Old and Middle rivers in about 35 percent of the months assuming a San Joaquin River inflow generally equal to those that occurred during the period 1930-1952. The second alternative evaluated the export levels that were possible by using 1953-1987 San Joaquin River inflows, yet still maintaining approximately the same downstream flow pattern as in the first alternative.

TABLE 7.2.3.2-2

ALTERNATIVE LEVELS OF PROTECTION
FOR DELTA FISHERIES (INCLUDING STRIPED BASS)
VIA EXPORT LIMITS

| Beneficial Use Protected and Method | Parameter | Description | Year Type | Values in CFS | | | |
|--|------------------------------------|---|------------|---------------|--------|--------|--------|
| | | | | 4/1-30 | 5/1-31 | 6/1-30 | 7/1-31 |
| FISH HABITAT | | | | | | | |
| (1) Export Limits with Pre-1950 SJR inflows | Combined Exports by CVP and SWP | Export limits needed to help minimize loss of eggs, larval and young fish through export pumps and diversions by making flows positive (about 500 cfs) downstream in Old and Middle rivers. | Wet | 7,000 | 7,000 | 6,000 | 7,000 |
| | | | Ab. Normal | 6,000 | 6,000 | 5,000 | 6,000 |
| | | | Bl. Normal | 5,000 | 5,000 | 4,000 | 6,500 |
| | | | Dry | 3,500 | 3,500 | 3,500 | 5,750 |
| | | | Critical | 3,500 | 3,500 | 3,500 | NA |
| (2) Export Limits with 1953-87 SJR Post-CVP inflows | Combined Exports by CVP and SWP | Export limits needed to help minimize loss of eggs, larval and young fish through export pumps and diversions by making flows positive (about 500 cfs) downstream in Old and Middle rivers. | Wet | 10,000 | 8,000 | 6,000 | 4,000 |
| | | | Ab. Normal | 2,000 | 2,000 | 1,000 | 1,000 |
| | | | Bl. Normal | 1,000 | 1,000 | 1,000 | 1,000 |
| | | | Dry | 1,000 | 1,000 | 1,000 | 1,000 |
| | | | Critical | 1,000 | 1,000 | 1,000 | NA |
| (3) Export Limits with 1953-67 Pre-SWP Avg. exports | Combined Exports by CVP and SWP | Exports under recent historic conditions which restricted loss of egg and larval fish to pumps and diversions, flow in Old and Middle rivers generally downstream. | Wet | 10,000 | 8,000 | 6,000 | 3,300 |
| | | | Ab. Normal | 2,000 | 2,900 | 3,700 | 4,200 |
| | | | Bl. Normal | 2,000 | 2,000 | 2,900 | 3,300 |
| | | | Dry | 3,000 | 3,300 | 4,000 | 4,600 |
| | | | Critical | 2,800 | 2,800 | 3,000 | 4,300 |
| (4) Export Limits Delta Plan | Combined Exports by CVP and SWP | Exports under Delta Plan conditions intended to reduce loss of egg and larval fish to pumps and diversions, no consideration for flow direction in San Joaquin, Old, or Middle rivers. | All | NA | 6,000 | 6,000 | 9,200 |

7-15

*3rd alternative
pre-SWP export
conditions
1953-67*

The third alternative addresses the return to export conditions as they existed on the average after the start of substantial exports by the CVP and operation of the Delta Cross Channel gates (1953) but prior to the SWP operation in 1967. The export rates during April-July for the various water year types (based on the new San Joaquin River Basin definition) during this period were averaged to obtain these values. Exports were adjusted to be higher in wet years than those actually observed during the 1953-1967 period. Positive downstream flows in Old and Middle rivers would result with this alternative's high San Joaquin River inflows even at the elevated export rates.

During 1953-1967, exports were much lower than they are at present. Old and Middle river flows were not always positive, but the Delta fishery was less affected by the effects of exports than they are today. As discussed previously, of the five hypothesized causes for the recent striped bass decline, four relate to project operations. Returning to export rates reflective of a time when Delta fisheries (especially striped bass) were doing much better than they are today is no guarantee that the declines in these populations will be reversed. However, it does provide for improving spring Delta conditions which presumably will benefit the fishery. This alternative is a step toward achieving the fishery agencies' desired goal of positive downstream flow by reducing the magnitude of reverse flows. It is anticipated that the proposed conditions will also enhance overall salmon smolt survival through increased streamflow and reduced entrainment.

The fourth alternative would retain current export limitations for May, June and July contained in the 1978 Delta Plan, with no specific export limitations for April.

7.2.3.3 Other Beneficial Uses

- American Shad

As noted in Chapter 5, American shad have been impacted by the present Plan standards. The data presented by DFG do not provide an accurate picture of what these impacts are. In addition, much of the information developed on shad resulted as a by product of investigations of other species, rather than a detailed study of the particular needs of shad. In any case, DFG did not propose any specific objectives for shad, just as they did not in the 1978 Plan. Their belief, then as now, is that the striped bass objectives they proposed will benefit shad as well.

This concept of collateral protection for shad seems to be appropriate for the present Plan as well. An examination of the optimal needs for shad in Section 5.3.6 shows that, particularly during the spring, shad are quite similar to striped bass, in terms of the need for adequate flows, reduced translocation out of the Sacramento River into the central

Delta, and reduced entrainment by diversions and exports. The flows, export limitations and Delta Cross Channel gate operations discussed for salmon and striped bass should provide shad substantial increases in protection compared to the 1978 Plan.

The major difference between the shad and striped bass is that some young shad remain in the Delta or in tributary streams into the summer and fall, while the young striped bass tend to be largely out of the Delta by the end of July. These late summer and fall outmigrating shad will not receive specific protection under the proposed Plan. The proportion of the population which are late outmigrants is not known, but it is assumed that increased protection for striped bass provided in the April-July period will accomplish three things: 1) provide better migration and spawning habitat for adult shad; 2) provide increased protection for the earlier migrants; and 3) perhaps increase the proportion of early migrants because of the increased flows in tributary streams during the April-July period to meet Delta inflow and outflow requirements. Better documentation of the population dynamics and needs of American shad need to be provided before definitive objectives can be considered for that species. As noted, the non-1978 Delta Plan levels of protection presented for striped bass should provide additional protection for shad, compared to present conditions.

- Migratory Fish Food Chains

The Phase I of the hearing included considerable discussion of the food chains in the Bay and Delta, particularly the food requirements of young outmigrating striped bass and shad. Limited information was presented on the requirements of salmon smolts. All three species begin feeding on very small invertebrates, such as copepods (and small insects in the case of salmon and shad), and then progress to larger invertebrate species, particularly Neomysis. The data presented indicate that the food chain of the Estuary, particularly the Delta, is in a very dynamic state at present. Delta phytoplankton blooms, presumed to be a major component of the base of the food chain, have been dominated by the chain diatom Melosira in recent years. The value of this species as food for copepods and Neomysis is unclear. In addition, the traditionally dominant copepod Eurytemora, a preferred food source for young striped bass, has been at least partially replaced by the introduced copepod, Sinocalanus. The recent appearances of the clam Potamocorbula amurensis, and the benthic amphipod Lagunogammarus, both recently introduced and rapidly expanding in range and numbers, further complicate our limited understanding of the food chain dynamics of young striped bass and shad. Attempting to set objectives in such a changing environment is not possible at present.

In general, the proposed increased spring flows and reduced exports may result in a Delta and Suisun Bay habitat more conducive to the propagation of those species which have been

beneficial to species in food chains of young anadromous fish in the past, since the habitat will approximate those earlier conditions more closely. However, there is no guarantee that this will occur. In any case, the understanding of the dynamics and interactions of the food chains in the Estuary must be greatly increased before proposed objectives for protection of the food chains can be considered. Indeed, there has not been demonstrated at present solid evidence that the changes in the food chains are having a deleterious effect on young striped bass, salmon, shad, or other Estuary species. Considerable additional effort in this area is warranted.

- Striped Bass Migration Up the San Joaquin River

As discussed in Chapter 5, striped bass generally do not migrate upstream into water with an electrical conductivity (EC) in excess of about 0.550 mmhos/cm, and appear to prefer spawning in water fresher than about 0.300 mmhos/cm. The Delta Plan objectives call for a maximum of 0.550 mmhos/cm at Prisoners Point for the period April 1 to May 5. While this objective may still impose a migration limit on striped bass, the other proposed objectives may somewhat compensate for this limitation. Increased outflows and reduced exports during the April-July period should result in greater outmigration of larvae produced in the San Joaquin River spawning area than at present, with presumably greater survival. In addition, increased flows in the San Joaquin River in wet and above normal years, combined with the reduced exports, may result in water quality better than that provided by the proposed objective. This may result in removal of, or at least a reduction in, this upstream barrier in wetter years. Additional monitoring of salinity in the mainstem San Joaquin, combined with better sampling for striped bass eggs and larvae in the eastern Delta, will provide additional information on the effects of the proposed objectives and the potential use of the San Joaquin River by striped bass in wetter year types. Available data are not adequate to attempt to propose a lower EC objective in the San Joaquin River.

- Races of Chinook Salmon Other Than Fall Run

Very little information is available on the other three races of Chinook salmon using the Estuary. What was presented in the Phase I of the hearing was not sufficient to identify flow or water quality needs, nor to develop water quality objectives. Additional studies are needed to develop such information.

- Other Aquatic Resources

A variety of other aquatic resources considered in the Phase I of the hearing, including: phytoplankton and zooplankton in San Francisco Bay, Bay outflow and offshore habitat, freshwater and estuarine benthic organisms, bay fish, Delta resident and other anadromous fish, pollutant flushing flows,

upstream uses, export fishery habitat, export recreation, and Estuary recreation. After due consideration, no specific flow or salinity objectives is proposed for any of these aquatic resources. In most cases, the absence of specific objectives is due to lack of sufficient information upon which to base objectives, or because the aquatic resources are already protected under another objective. For example, no specific objectives are proposed for export fishery habitat or export recreation because the Municipal and Industrial objectives discussed previously for export water provides adequate protection for these aquatic resources as well. The specific reasons for the absence of proposed objectives for these resources is discussed in Chapter 4.

7.2.3.4 Suisun Marsh

- Managed Wetlands

The Suisun Marsh consists of about 50,000 acres of managed wetlands and 7,000 acres of tidal marsh. DFG, Suisun Resource Conservation District, DWR and USBR have entered into an agreement to protect these managed wetlands and mitigate for the loss of about 900 acres of managed wetland and tidal marsh impacted by facility construction and reduced outflows. This agreement allows water quality relaxation beyond the water quality objectives contained in the 1978 Delta Plan, Water Right Decision 1485 and State Board Order of December 5, 1985. The only major difference between the objectives being considered and those in the agreement is in the determination of water year types. For consistency with the other objectives, compliance with these objectives will be determined by using the water year types set forth in Chapter 3. This includes the use of the 50th percentile forecast of future runoff conditions instead of the 20th percentile as set forth in the agreement.

- Tidal Marshes

One concern left unresolved in the testimony presented in Phase I is the protection of rare and endangered species that inhabit the tidal marsh in Suisun Bay and the Suisun Marsh areas outside the managed wetlands. The provision of flows specifically to protect these areas could result in an additional 600,000 acre-feet to be released on the average each year during dry periods. This amount is above and beyond that required under the alternatives discussed in the following section. The DFG, the agency responsible for the protection of rare and endangered species, is requested to provide the Board in Phase II with its recommendations on how rare and endangered species in the tidal marsh areas of Suisun Bay and Suisun Marsh should be protected via this Water Quality Control Plan.

7.2.3.5 San Francisco Bay

San Francisco Bay was discussed extensively during the Board's Phase I of the hearing. This information was addressed in detail in Chapters 4 and 5. The information presented did not provide an adequate connection between physical changes in the Bay due to inflows and the beneficial uses in the Bay. The evidence presented was judged not sufficient as a basis for water quality objectives. Further studies should be performed to address these concerns. The concerns regarding protection of San Francisco Bay should also be addressed during consideration of the water right permits of any large unconstructed water storage projects.

7.3 Development of Alternative Objectives

There are many possible alternative sets of water quality objectives that can be developed from the water quality and flow needs for Bay-Delta Estuary uses presented in the previous section. Six logical alternatives that span this range of needs have been selected. The alternatives and the level of protection provided each beneficial use are presented in Table 7.3-1.

This section discusses the global balancing of the various beneficial uses of Bay-Delta waters. This global process builds upon all the information presented thus far, especially the California water ethic, to produce a recommended set of water quality objectives that reasonably protect the beneficial uses of Bay-Delta Estuary waters.

In the balancing process, one must recognize that biological resources have declined and currently are not experiencing the same degree of protection as other beneficial uses. In light of the evidence submitted during the Phase I hearing, past attempts to protect biological resources in the Estuary have not achieved the level of protection sought. Declines in biological resources of the Estuary need to be taken into consideration in the current balancing process.

7.3.1 Effects on Water Availability

To develop balanced water quality objectives, assessment must be made of the impacts resulting from the objectives under consideration.

This is done by determining the controlling flow and salinity objectives, i.e., those which require the most water to attain, for each alternative and comparing the water requirements against a base condition. Two base conditions were used to provide a range of impacts: (1) a 1990 level of development operations study which uses the water quality standards of the 1978 Delta Plan as a constraint and (2) the actual historical conditions that existed between 1972-1987, excluding the wettest year of record, 1983. (Excluding this year, the wettest of record that shows the average, makes the average San Joaquin River Basin April through July unimpaired flows for these two hydrologic periods almost identical.) The differences between the alternative and the base are then calculated for each month and summarized by water year type.

TABLE 7.3-1

ALTERNATIVE SETS OF WATER QUALITY OBJECTIVES

| Alternatives | (1) | (2) | (3) | (4) | (5) | (6) |
|--|---|----------------------------------|-----------------------------------|--|----------------------------------|-------------|
| Description of key provisions | Optimal Level | High SJR Flows High Exports | Moderate SJR Flows Low Exports | Moderate SJR Flows Delta Plan Exports | Recommended Plan | No Action |
| Beneficial Use | | | | | | |
| Municip. & Indust. (Footnote 1) | 150 mg/l Chloride (Contra Costa Canal) 250 mg/l Chloride elsewhere | 250 mg/l Chloride | 250 mg/l Chloride | 250 mg/l Chloride | 250 mg/l Chloride | Delta Plan |
| West Delta Ag. (Footnote 2) | 1.5 mmho/cm EC | 1.5 mmho/cm EC 3.0 mmho/cm EC | 1.5 mmho/cm EC 3.0 mmho/cm EC | 1.5 mmho/cm EC 3.0 mmho/cm EC | 1.5 mmho/cm EC 3.0 mmho/cm EC | Delta Plan |
| South Delta Ag. (Footnote 3) | Delta Plan | Delta Plan | Delta Plan | Delta Plan | Delta Plan | New Melones |
| Sacto. Salmon (Footnote 4) | 22,500 cfs | 1930-1952 | 1930-1987 | 1930-1987 | 1930-1987 | Delta Plan |
| SJR Salmon (Footnote 4) | 20,000 cfs | 1930-1952 | 1953-1987 | 1953-1987 | 1953-1987 | Delta Plan |
| Delta Fishery Outflow object. (Footnote 5) | Optimal Flows | Staff | Staff | DFG | DFG p.7-13 | Delta Plan |
| Delta Fishery Export limit (Footnote 5) | No exports May-Nov | Pos. Downstream Flow High SJR | Pos. Downstream Flow Low SJR | Delta Plan Exports | 1953-1967 exports | Delta Plan |
| Suisun Marsh (Footnote 6) | Optimal Salinities | 4-Agency Agreement | 4-Agency Agreement | Delta Plan | 4-Agency Agreement | Delta Plan |
| San Francisco Bay (Footnote 7) | Further Study | Further Study | Further Study | Further Study | Further Study | |

Footnote 1: See Section 7.2.1 for further description.

Footnote 2: See Section 7.2.2.1 for further description.

Footnote 3: See Section 7.2.2.2 for further description.

Footnote 4: See Section 7.2.3.1 for further description.

Footnote 5: See Section 7.2.3.2 for further description.

Footnote 6: See Section 7.2.3.4 for further description.

Footnote 7: See Chapter 4 under San Francisco Bay for further description.

7-21

See App. 7-7
Table
7.2.3.1
p.7-8

p. 7-16, 7-15 data table
combined CUP&SWA.

7.3.1.1 The 1990 Level of Development Operations Study

The Operations Study used is that which was presented as DWR Exhibit 30 during the Phase I of the hearing, except that a carriage water requirement to meet a 250 mg/l chloride objective was used. This study uses the 1978 Delta Plan and New Melones criteria for the southern Delta as the controlling Delta objectives. The operation study uses the hydrological runoff conditions experienced from 1922 through 1978.

There are certain peculiarities about this study that must be emphasized. First, the average annual exports are about 6.1 million acre-feet for the entire study, whereas the maximum export for any water year to date has been the 1985 level of approximately 5.5 million acre-feet. Apparently the 1990 operation study has a built-in expansion of exports of about 0.6 million acre-feet beyond that seen in any year since the CVP and SWP have been operating. Review of the data indicates that virtually all this increase occurs in the months of October-April. This factor is important when comparing the impacts of these studies to the reasonable consumptive needs discussed in Chapter 6.

DWR includes an export expansion factor in its study

Second, the operations study somewhat overstates DWR's 1987 estimates of current agricultural net use in the Sacramento and San Joaquin basins. This is important when comparing alternatives to present or expected future conditions. The 1990 operation has enough agricultural demand built into it to satisfy in-basin growth through the year 2010 and beyond.

Also, one must keep in mind that operations studies are estimates, not reality. They are, in effect, a set of common rules by which alternatives can be compared; they are not intended to reflect how projects will actually operate. The results here are presented only to compare alternatives.

The output of the 1990 operations study presented by DWR was used to perform the analysis of alternatives. By changing the controlling Delta inflow and outflow objectives or export limits and keeping all other aspects of the study the same, we can compare the increases, or decreases, in flow required each month for the alternative in question beyond that of the 1978 Delta Plan. Care must be taken when determining the flows required to meet the controlling objectives to evaluate controlling objectives separately for the San Joaquin River, Sacramento River, as well as Delta outflow. By carefully evaluating months with surpluses, one can determine if water is saved under the new alternative or is needed to satisfy the new objectives. The process is simple in concept but is complicated in practice. Only summaries of the results of these studies will be presented here.

7.3.1.2 The 1972-87 Historical Base

The second base from which water supply impacts of the various alternative plans are compared is the 1972-87 actual historical

conditions. As stated previously, the year 1983 was not used in this analysis. During most of the 1972-87 period the 1978 Delta Plan was in effect. During the time prior to 1978, the objectives of the Delta Plan were generally met with extra flows in the Delta beyond water project needs. The base flows for each month in this period were compared with those needed to meet the flows of each of the alternatives based on year type. The historical base flows were obtained from the DWR DAYFLOW data set, except for Delta outflow which was estimated using DWR consumptive use planning values (SWRCB, 1, Q-4). The process of comparison used is the same as that discussed for the 1990 operations study.

7.3.1.3 Assumptions Used in the Evaluation of Alternatives

A schematic showing the Delta's hydrologic scheme used in the water supply impact analysis is illustrated in Figure 7.3.1.3-1. The following are the assumptions used to evaluate the water supply impacts of alternative water quality objectives. These assumptions apply to both the 1990 operations study and the 1972-1987 historical period:

- (1) All of the Estuary water quality objective locations were assigned to the Sacramento River system April through July hydrologic classification, except the following locations, which were assigned to the San Joaquin River system April through July hydrologic classification:
 - o San Joaquin River near Vernalis
 - o San Joaquin River at Mossdale
 - o San Joaquin River at the former location of Brandt Br.
 - o Bifurcation of Old and Middle River
 - o Middle River at Howard Road Bridge
 - o Old River at Tracy Road Bridge
 - o Delta Mendota Canal at Tracy Pumping Plant
 - o Clifton Court Forebay Intake at West Canal

- (2) The Delta flow and salinity conditions necessary to meet objectives can be achieved through control of flows, exports, or gate operations at the Delta "control points." If the control point flows, exports, or gate operations are adequate to meet the local controlling objective, the other (noncontrolling) objectives within local influence of the control points are assumed to be met. The Delta control points are as follows:
 - o Chipps Island
 - o San Joaquin River at Vernalis
 - o Sacramento River at Sacramento
 - o The Banks and Tracy Pumping Plants
 - o The Delta Cross-Channel near Walnut Grove

These control points are illustrated in Figure 7.3.1.3-1.

- (3) The following basic equations apply for each of the hydrologic bases:

FIGURE 7.3.1.3-1

DELTA HYDROLOGIC SCHEME USED IN THE WATER SUPPLY IMPACT ANALYSIS

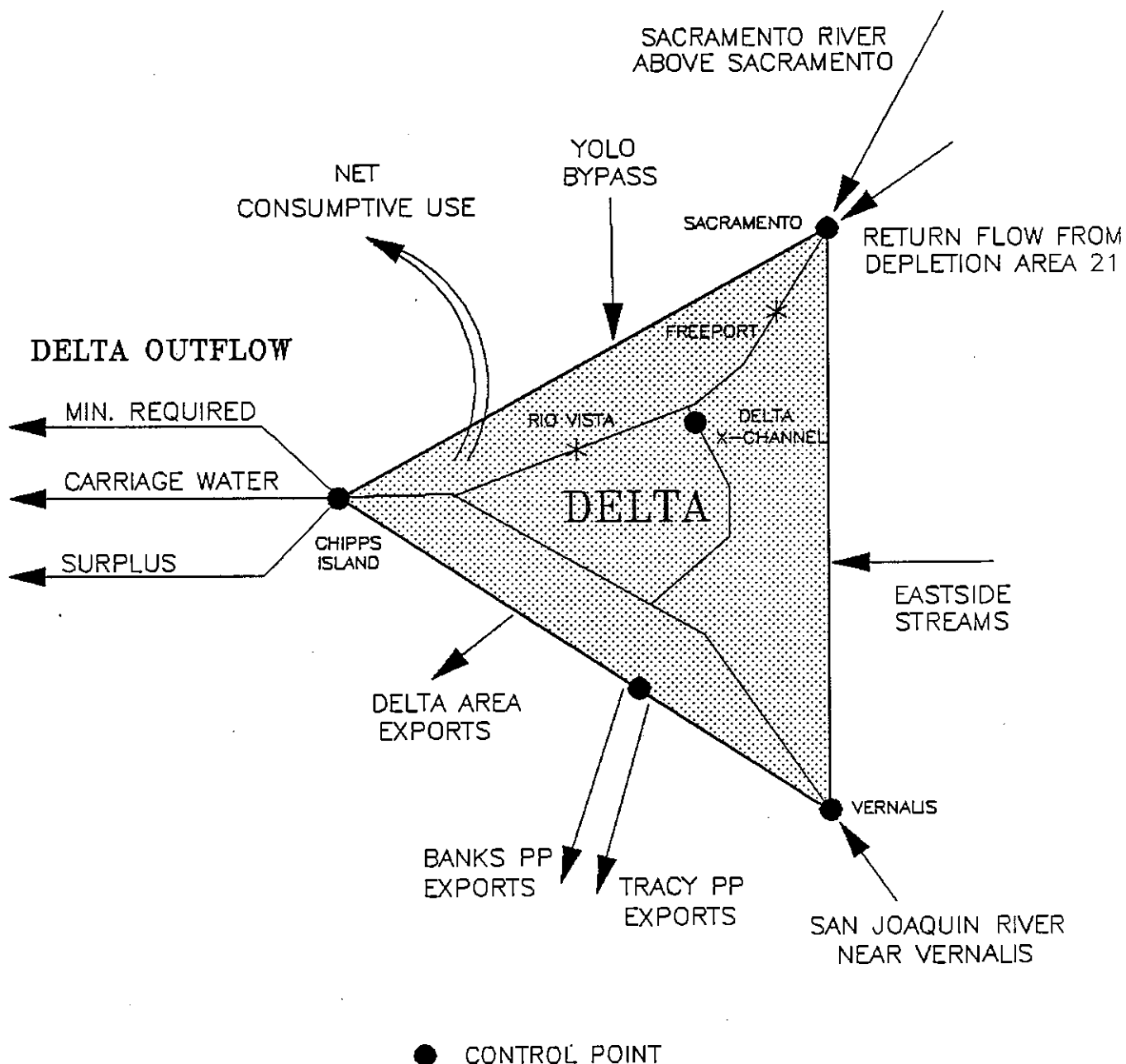

- The Delta outflow at Chipps Island, DO is defined as follows:

$$DO = DI - NETCU - AREADIV - B\&TEXP \quad (1)$$

where: DI = Delta inflow
 NETCU = Net Delta consumptive use
 AREADIV = Delta area diversions
 B&TEXP = Banks and Tracy Pumping Plan exports

- The Delta inflow, DI, is defined as follows:

$$DI = SAC + YOLO + RF21 + SJR + EAST \quad (2)$$

where: SAC = Sacramento River flow above Sacramento
 YOLO = Yolo Bypass flow
 RF21 = Return flow from depletion ares 21
 SJR = San Joaquin River near Vernalis flow
 EAST = East side tributaries flow (Mokelumne, Cosumnes and Calaveras rivers)

- The net consumptive use, NETCU, is defined as follows:

$$NETCU = CU - PREC \quad (3)$$

where: CU = Delta consumptive use
 PREC = Delta precipitation

- The Delta area diversions, AREADIV, is defined as follows:

$$AREADIV = VALL + NBA + CCC + MDIV \quad (4)$$

where: VALL = City of Vallejo Diversions
 NBA = North Bay Aqueduct Diversions
 CCC = Contra Costa Canal Diversions
 MDIV = Miscellaneous Delta Diversions
 (MDIV = 0 for the 1990 level-of-development runs)

- The Banks and Tracy Pumping Plants' exports, B&TEXP, is defined as follows:

$$B\&TEXP = BANKS + TRACY \quad (5)$$

where: BANKS = Total Banks Pumping Plant exports
 TRACY = Tracy Pumping Plant exports

- The Delta outflow, DO, can also be divided into three components:

$$DO = MINRQDO + CWDO + SURPDO \quad (6)$$

where: MINRQDO = Minimum required Delta outflow at Chipps Island
 CWDO = Carriage water requirement at Chipps Island
 SURPDO = Surplus Delta outflow at Chipps Island

- The carriage water requirements can be adequately estimated using the method described in DWR Exhibit 30 and the effective export, EFFEXP. The effective export, EFFEXP, is defined as follows:

$$\text{EFFEXP} = \text{BANKS} + \text{TRACY} - \text{SJR} - \text{EAST} - \text{CCC} \quad (7)$$

(see note below)

Note: the CCC "export" was not included in DWR's 1990 level of development (LOD) analysis, even though the carriage water curves were developed using the "export" of the CCC; consequently, the alternative carriage water was estimated without the CCC to conform with the 1990 LOD analysis.

- The carriage water requirements for the alternatives were estimated using DWR's Carriage Water Table 5, which assumes the following objectives:
 - 250 mg/l chlorides at Clifton Court and Rock Slough in all years. (DWR assumed a Rock Slough "operational" objective of 225 mg/l chloride to provide an operational buffer to the 250 mg/l chloride objective.)
 - 1.5 mmhos/cm EC at Jersey Point from April 1 through August 15 in all years except EC critical; 1.5 mmhos/cm EC at Jersey Point from April 1 through June 30 and 3.0 mmhos/cm EC from July 1 through August 15 in critical water years.

If 1978 Delta Plan surplus Delta outflows occur, then projected reductions in minimum flow requirements in the San Joaquin River near Vernalis and the Sacramento River at Sacramento are considered water that could not be saved; conversely, if 1978 Delta Plan surpluses are zero, then projected reductions in minimum flow requirements are considered "savable" and are applied to offset water requirements in other months.

To the extent that surplus Delta outflow under the 1978 Delta Plan is available, it is used to reduce the impacts of the alternatives. The surplus Delta outflow is adjusted depending on the change in 1) Chipps Island minimum flow requirements, 2) carriage water requirements, and 3) Banks and Tracy exports. If the 1978 Delta Plan surplus is zero, the alternative surplus is also zero.

The YOLO, RF21, EAST, NETCU, and AREADIV alternative flows remain the same as in the 1978 Delta Plan.

Additional water needed to meet Delta objectives, exports or consumptive uses is obtained from the Sacramento River Basin through the Sacramento River at Sacramento.

7.3.2 Evaluation of Alternative Plans

In order to evaluate these alternative sets of water quality objectives, a determination had to be made as to whether the flow requirements of each could be achieved through implementation of the new California water ethic discussed previously or whether existing uses would need to be curtailed. The present and future reasonable water needs are discussed in Chapter 6. Important findings for San Joaquin River Basin, Sacramento River Basin, and export areas are discussed below:

In the San Joaquin River Basin April-July flows to the Delta can be increased through (1) an aggressive conjunctive use of surface and ground waters, and (2) a reoperation of existing reservoirs in the Basin. An analysis for the San Joaquin River Basin indicated that the potential increase in April through July flows would probably range from about 0.17 MAF/yr during critically dry years to almost 0.7 MAF/yr during wet years. The average between 1972-87 was estimated at about 0.49 MAF/yr.

In the Sacramento River Basin about 0.550 MAF of water supply reserves exist through the year 2010 (DWR Bulletin 160-87). This reserve supply could be used to meet additional flow requirements in the Bay-Delta Estuary.

For the entire State reasonable consumptive agricultural needs will decrease by about 1.0 MAF/yr from 1985 to 2010. However, reasonable consumptive municipal and industrial needs will increase by about 1.1 MAF/yr from 1985 to 2010.

The south Coastal Area can provide adequate water supplies to expected populations through the year 2010 at existing Bay-Delta export levels provided (1) aggressive water conservation and reclamation measures are pursued, and (2) water saved through agricultural water conservation in the Coachella and Imperial and San Joaquin Valleys is made available to augment expected decreases in water supplies to the south Coastal Area from the Colorado River Basin area.

An analysis has been made of the CVP and SWP ability to make up in other months, exports which are foregone in April through July. If exports are curtailed during the April-July period, about 0.7 to 0.8 MAF on the average can be made up annually by utilizing currently available pumping capacity in other months (up to the Corps of Engineers pumping criteria) provided (1) water supplies from the Sacramento River system are available to satisfy this demand and its carriage water requirements, (2) reservoir storage south of the Delta is more fully utilized during the spring and summer, and (3) municipal water users utilize alternative water sources during the spring and early summer rather than relying on Delta Supplies. These users could then switch to Delta supplies during the late fall and winter. This analysis utilized 1985 export rates (the highest to date and 16 percent higher than the 1979-1987 average) and compared them to

exports expected in the fall and winter months under the 1990 operations study. The 1990 operations study shows that its average April through July exports are slightly higher than those experienced in 1985. However, it also shows higher pumping in the late fall and winter than currently exists under actual 1985 conditions by about 0.7 MAF per year. The 1990 operations study uses existing project facilities. Decreases in export pumping in April-July of around 0.7 MAF can be recouped in other periods.

Each alternative set of water quality objectives and their water supply impacts are discussed below. Table 7.3.2-1 tabulates the impacts of the alternatives compared to the 1990 level of development and Table 7.3.2-2 does the same but uses the historic base.

7.3.2.1 Alternative 1

Alternative 1 provides optimal protection to each beneficial use in the Estuary. This alternative was developed to provide a starting point for the analysis of the various other alternatives presented below. Each beneficial use in the Estuary for which adequate data are available was evaluated to determine what would be the ideal set of conditions for protection of that beneficial use. Each use was evaluated without regard for any other competing or complementary beneficial use. The purpose of this exercise was to indicate where different beneficial uses had similar needs, so that a single or few objectives could provide a measure of protection for several beneficial uses. For example, reductions in export levels in the spring months may provide benefit to the young of shad, salmon, and striped bass, as well as for western Delta agriculture. This knowledge provided greater flexibility in developing the other alternatives. Table 7.3.2-1 illustrates that April-July exports would be eliminated and average Delta outflow would increase by more than 7 million acre-feet. Large segments of California's population would no longer receive a water supply. The impacts of this alternative clearly are not reasonable.

7.3.2.2 Alternative 2

Alternative 2 provides the next highest level of protection of the beneficial uses for the Bay-Delta Estuary. Salmon fisheries are protected at the historical levels that existed generally prior to the 1950's. Flows for striped bass are set at levels initially proposed by State Board staff. The DFG and the USFWS recommended achievement of positive downstream flow in Old and Middle rivers during April-July. This alternative constrains exports in April-July to provide these flows about 38 percent of the time. Since striped bass and salmon have declined in the recent past, actions may be needed to prevent further decline and allow a reasonable recovery. Alternative 2 attempts to do this by increasing San Joaquin River flows on the average by about 1.0 to 1.3 million acre-feet during April-July (see Tables 7.3.2-1 and 7.3.2-2). This is an increase of about 200 percent. As stated previously, average flows in the San Joaquin can be increased by only about 0.5 MAF with an aggressive conjunctive use and reservoir reoperation program. Increases beyond this 0.5

TABLE 7.3.2-1

APRIL - JULY WATER SUPPLY IMPACTS
OF ALTERNATIVE SETS OF WATER QUALITY OBJECTIVES
1990 LEVEL OF DEVELOPMENT OPERATIONS STUDY (DWR 30)
AS THE BASE

| Base Conditions (Millions of Acre Feet) | Change in Base Flows Needed to Meet Alternative (Millions of Acre-Feet) | | | | | |
|--|--|---------------|---------------|---------------|---------------|---------------|
| | Alternative 1 | Alternative 2 | Alternative 3 | Alternative 4 | Alternative 5 | Alternative 6 |
| Average (Based on 57-year record) | | | | | | |
| Sacramento * | 2.2 | 0.402 | 0.579 | 0.689 | 0.358 | 0.000 |
| San Joaquin | 3.4 | 1.508 | 0.979 | 0.528 | 0.528 | 0.000 |
| Exports(-) | -1.7 | -0.465 | -1.074 | 0.000 | -0.676 | 0.000 |
| Other Flows ** | -0.268 | -0- | -0- | -0- | -0- | -0- |
| Total Delta Outflow | 3.707 | 2.175 | 2.181 | 1.217 | 1.562 | 0.000 |
| Wet (18 years out of 57-year record)*** | | | | | | |
| Sacramento | 0.8 | 1.238 | 1.480 | 0.402 | 0.132 | 0.000 |
| San Joaquin | 3.0 | 1.525 | 0.979 | 0.979 | 0.979 | 0.000 |
| Exports(-) | -1.7 | -0.297 | -0.539 | 0.000 | -0.406 | 0.000 |
| Other Flows | -0- | -0- | -0- | -0- | -0- | -0- |
| Total Delta Outflow | 7.028 | 3.060 | 2.998 | 1.381 | 1.517 | 0.000 |
| Above Normal (8 years out of 57) *** | | | | | | |
| Sacramento | 1.8 | 0.323 | 0.715 | 0.939 | 0.613 | 0.000 |
| San Joaquin | 3.2 | 1.255 | 0.621 | 0.621 | 0.621 | 0.000 |
| Exports(-) | -1.8 | -0.476 | -1.200 | 0.000 | -0.781 | 0.000 |
| Other Flows | -0.187 | -0- | -0- | -0- | -0- | -0- |
| Total Delta Outflow | 3.779 | 2.404 | 2.536 | 1.560 | 2.015 | 0.000 |
| Below Normal (14 years out of 57)*** | | | | | | |
| Sacramento | 2.5 | -0.074 | 0.000 | 1.253 | 0.689 | 0.000 |
| San Joaquin | 3.2 | 1.811 | 0.347 | 0.347 | 0.347 | 0.000 |
| Exports(-) | -1.8 | -0.251 | -1.604 | 0.000 | -1.004 | 0.000 |
| Other Flows | -0.598 | -0- | -0- | -0- | -0- | -0- |
| Total Delta Outflow | 2.151 | 7.9 | 2.078 | 1.991 | 2.040 | 0.000 |
| Dry (11 years out of 57)*** | | | | | | |
| Sacramento | 3.1 | -0.267 | -0.214 | 0.473 | 0.098 | 0.000 |
| San Joaquin | 3.2 | -0.914 | 0.182 | 0.182 | 0.182 | 0.000 |
| Exports(-) | -1.7 | -0.633 | -1.349 | 0.000 | -0.823 | 0.000 |
| Other Flows | -0.687 | -0- | -0- | -0- | -0- | -0- |
| Total Delta Outflow | 1.638 | 8.3 | 1.280 | 0.655 | 1.103 | 0.000 |
| Critical (6 years out of 57)*** | | | | | | |
| Sacramento | 4.3 | 0.335 | 0.404 | 0.300 | 0.177 | 0.000 |
| San Joaquin | 3.4 | 0.419 | 0.104 | 0.104 | 0.104 | 0.000 |
| Exports(-) | -1.2 | -0.324 | -0.775 | 0.000 | -0.316 | 0.000 |
| Other Flows | -0.728 | -0- | -0- | -0- | -0- | -0- |
| Total Delta Outflow | 1.101 | 8.9 | 1.078 | 0.404 | 0.597 | 0.000 |
| 1928-34 Dry Period (7 years) | | | | | | |
| Sacramento | 3.6 | 0.095 | 0.157 | 0.651 | 0.482 | 0.000 |
| San Joaquin | 3.6 | 1.070 | 0.326 | 0.326 | 0.326 | 0.000 |
| Exports(-) | -1.5 | -0.416 | -1.199 | 0.000 | -0.538 | 0.000 |
| Other Flows | -0.67 | -0- | -0- | -0- | -0- | -0- |
| Total Delta Outflow | 1.443 | 8.6 | 1.581 | 0.877 | 1.276 | 0.000 |

* Includes return flows from Hydrologic Study Area 21.

** Banks and Tracy Pumping Plants only.

*** Alternatives are summarized based on Sacramento Basin year types. However objectives for San Joaquin River and exports were always based on San Joaquin Basin year types, even when different from Sacramento Basin year type.

TABLE 7.3.2-2

APRIL - JULY WATER SUPPLY IMPACTS
OF ALTERNATIVE SETS OF WATER QUALITY OBJECTIVES
HISTORICAL LEVEL OF DEVELOPMENT USING VALUES FROM
YEARS 1972-87 (EXCEPT 1983) AS BASE

| Base Conditions (Millions of Acre Feet) | | Change in Base Flows Needed to Meet Alternative (Millions of Acre-Feet) | | | | | |
|--|--------------|--|---------------|---------------|---------------|---------------|---------------|
| | | Alternative 1 | Alternative 2 | Alternative 3 | Alternative 4 | Alternative 5 | Alternative 6 |
| Average (Based on 15 years of record) | | | | | | | |
| Sacramento | 4.558 | 2.671 | 0.401 | 0.525 | 0.687 | 0.474 | 0.000 |
| San Joaquin | 1.066 | 2.936 | 0.995 | 0.406 | 0.406 | 0.406 | 0.000 |
| Exports(-) * | 1.397 | -1.397 | -0.132 | -0.556 | -0- | -0.201 | 0.000 |
| Other Flows | -0.202 | -0- | -0- | -0- | -0- | -0- | -0- |
| Total Delta Outflow | 4.025 | 7.004 | 1.528 | 1.487 | 1.093 | 1.081 | 0.000 |
| Wet (3 of 15 years) ** | | | | | | | |
| Sacramento | 8.231 | 0.516 | 0.928 | 1.159 | 0.026 | -0.064 | 0.000 |
| San Joaquin | 1.733 | 2.471 | 1.340 | 1.066 | 1.066 | 1.066 | 0.000 |
| Exports(-) | 1.506 | -1.506 | 0.096 | 0.151 | -0- | -0.118 | 0.000 |
| Other Flows | 1.541 | -0- | -0- | -0- | -0- | -0- | -0- |
| Total Delta Outflow | 9.999 | 4.493 | 2.172 | 2.074 | 1.092 | 1.12 | 0.000 |
| Above Normal (1 of 15 years) | | | | | | | |
| Sacramento | 5.495 | 1.748 | 0.605 | 0.826 | 0.671 | -0.449 | 0.000 |
| San Joaquin | 2.905 | 1.241 | 0.730 | 0.224 | 0.224 | 0.224 | 0.000 |
| Exports(-) | 1.304 | -1.304 | 0.302 | 0.357 | -0- | -0.324 | 0.000 |
| Other Flows | -0.233 | -0- | -0- | -0- | -0- | -0- | -0- |
| Total Delta Outflow | 6.863 | 4.293 | 1.033 | 0.693 | 0.895 | 0.099 | 0.000 |
| Below Normal (6 of 15 years) | | | | | | | |
| Sacramento | 3.995 | 2.669 | 0.117 | 0.243 | 1.137 | 0.787 | 0.000 |
| San Joaquin | 1.018 | 3.025 | 1.229 | 0.379 | 0.379 | 0.379 | 0.000 |
| Exports(-) | 1.510 | -1.510 | -0.168 | -0.787 | -0- | -0.380 | 0.000 |
| Other Flows | -0.511 | -0- | -0- | -0- | -0- | -0- | -0- |
| Total Delta Outflow | 2.992 | 7.204 | 1.514 | 1.409 | 1.516 | 1.546 | 0.000 |
| Dry (1 of 15 years) | | | | | | | |
| Sacramento | 3.347 | 3.584 | 0.063 | 0.110 | 1.171 | 0.690 | 0.000 |
| San Joaquin | 0.539 | 3.323 | 0.643 | -0.115 | -0.115 | -0.115 | 0.000 |
| Exports(-) | 1.738 | -1.738 | -0.790 | -1.544 | -0- | -0.740 | 0.000 |
| Other Flows | -0.813 | -0- | -0- | -0- | -0- | -0- | -0- |
| Total Delta Outflow | 1.335 | 8.645 | 1.496 | 1.539 | 1.056 | 1.315 | 0.000 |
| Critical (4 of 15 years) | | | | | | | |
| Sacramento | 2.715 | 4.291 | 0.466 | 0.501 | 0.398 | 0.360 | 0.000 |
| San Joaquin | 0.309 | 3.480 | 0.541 | 0.127 | 0.127 | 0.127 | 0.000 |
| Exports(-) | 1.085 | -1.085 | -0.195 | -0.722 | -0- | -0.168 | 0.000 |
| Other Flows | -0.882 | -0- | -0- | -0- | -0- | -0- | -0- |
| Total Delta Outflow | 1.057 | 8.856 | 1.202 | 1.350 | 0.525 | 0.655 | 0.000 |

* Banks and Tracy Pumping Plants only.

** Alternatives are summarized based on Sacramento Basin year types. However objectives for San Joaquin River and exports were always based on San Joaquin Basin year types, even when different from Sacramento Basin year type.

7-30

MAF level would likely require a curtailment of existing uses in the Basin. This alternative would provide greatly enhanced protection to Estuary uses over those existing levels while having a significant impact on upstream users. This does not appear to be reasonable.

7.3.2.3 Alternative 3

Alternative 3 provides protection to the salmon resources in the Sacramento River system by preserving the April-June flows (shown to be important to salmon) at levels that have existed on the average over the period of record (1930-1987). However, on the San Joaquin River system a more modest level of protection is sought. It represents a more recent period of flows reflective of the current Delta physical condition (1953-87). This level of protection is more achievable on the San Joaquin system than that provided under Alternative 2. This level of protection is better than that provided under the no action alternative. It would prevent the important spring flows in the San Joaquin River from dropping any lower in the future as would be expected under the no action alternative. Since the level of protection sought is an average over a 35-year period, and reflects a level that generally occurred before these two fishery resources were showing a dramatic decline, it actually provides some increase over present day flows.

Striped bass protection is at levels initially proposed by State Board staff. Exports are decreased to allow for positive net downstream flows in April-July about 35 percent of the time in Old and Middle Rivers.

As shown in Tables 7.3.2-1 and 7.3.2-2, Alternative 3 reduces the average April-July water flow demands on the San Joaquin River system between 0.53 and 0.41 MAF above the base flows. This is a more achievable level. However, in so doing, it also calls for reductions in spring exports over those planned in the future by about 1.1 MAF. This represents about a 65 percent decrease in April-July exports. Some of this decrease may be able to be regained through increased exports in other months at the cost of building addition storage south of the Delta. However, this entire amount could not be regained without additional facilities in the Delta.

7.3.2.4 Alternative 4

Alternative 4 is the same as Alternative 3 except it retains the export limitations set forth in the current Delta Plan and the Delta outflows for striped bass as recommended by DFG and the USFWS. This means that the only mechanism used to address the concerns raised regarding the status of the salmon and striped bass fisheries is to increase flows. Exporters are not asked to shoulder any of the burden even though export operations are known to have effects on internal Delta flows and physically remove millions of young fish each year. The water supply impacts are shown in Table 7.3.2-1 and 7.3.2-2. Although this alternative has the least overall impact on water users, it too

does not provide an equitable sharing of responsibilities to protect beneficial uses in the Bay-Delta Estuary.

7.3.2.5 Alternative 5

Alternative 5 offers the level of flows for protection of salmon as set forth under Alternative 3. However, outflow protection provided to striped bass is commensurate with that recommended by the DFG and the USFWS. Both the DFG and the USFWS recommended that some reduction in spring exports be achieved. However, neither made specific recommendations. Under this alternative, in April-July exports are established to reflect the conditions that occurred during a time when both striped bass and salmon populations were in much healthier conditions, prior to the increased export of the SWP (1953-1967 - see Figure 4.5.1.2-4). Reducing exports to the period before the SWP does not always provide the positive downstream flow in Old and Middle rivers sought by many fishery groups. Under this alternative, positive flows occur only about 20 percent of the time during April-July. It does reduce the magnitude of reverse flows compared to present conditions. A safe level of exports is not known. However, pre-SWP spring export rates appears to be a reasonable interim goal until a safe level of exports is found.

to 70,000 MAF impact on exports in spring

The average impact on existing and planned spring exports is a decrease of about 0.67 MAF. Compared to the last 15 years of spring exports, they would be reduced by about 0.2 MAF. In order to make up for this decrease in spring exports the CVP and SWP could increase exports in fall and winter months above today's levels as planned in their 1990 operations study. This is possible with existing facilities as shown in DWR's 1990 operations study. These actions would in effect freeze existing total annual exports at about the 1985 levels. The 1985 level of exports is the highest to date and 16 percent higher than the average level of exports since implementation of the 1978 Delta Plan. However, as shown in Chapter 6, this level of Delta supply is sufficient to meet reasonable water demands south and west of the Delta through the year 2010.

7.3.2.6 Alternative 6

Alternative 6 is the no action alternative. As stated previously, continuation of this alternative is expected to result in a decrease in April-June flows in both the San Joaquin River and the Sacramento River at Rio Vista. Exports in the October-April period will increase by at least 0.6 MAF above the highest levels experienced to date. All this will take place while the natural population of salmon continues to decline and the index of young striped bass is at its lowest levels ever recorded. In addition, the southern Delta will continue to receive inadequate protection.

In the face of these decreases in Estuary beneficial use protection and the benefits received by the water use community, the no action alternative appears to be inequitable.

7.3.2.7 Recommended Alternative

In light of this review, Alternative 5 is the recommended alternative.

Figure 7.3.2.7-1 and Figure 7.3.2.7-2 show in bar chart form the water supply impacts of the recommended alternative using the 1990 operations study as a base and the 1972-87 historical period as a base, respectively. The April-July data shown in these bar charts are from Tables 7.3.2-1 and 7.3.2-2. The figures allow the comparison of recommended changes to the average base condition for each control point in the Delta, i.e., Delta outflow, Sacramento River, San Joaquin River and Tracy and Banks exports.

The water quality objectives derived from the recommended alternative are shown in Table 1 (see Chapter 1, Executive Summary).

FIGURE 7.3.2.7-1 RECOMMENDED PLAN WATER SUPPLY IMPACTS 1922-78 HYDROLOGY UNDER THE PRESENT LEVEL-OF-DEVELOPMENT AVERAGE ANNUAL

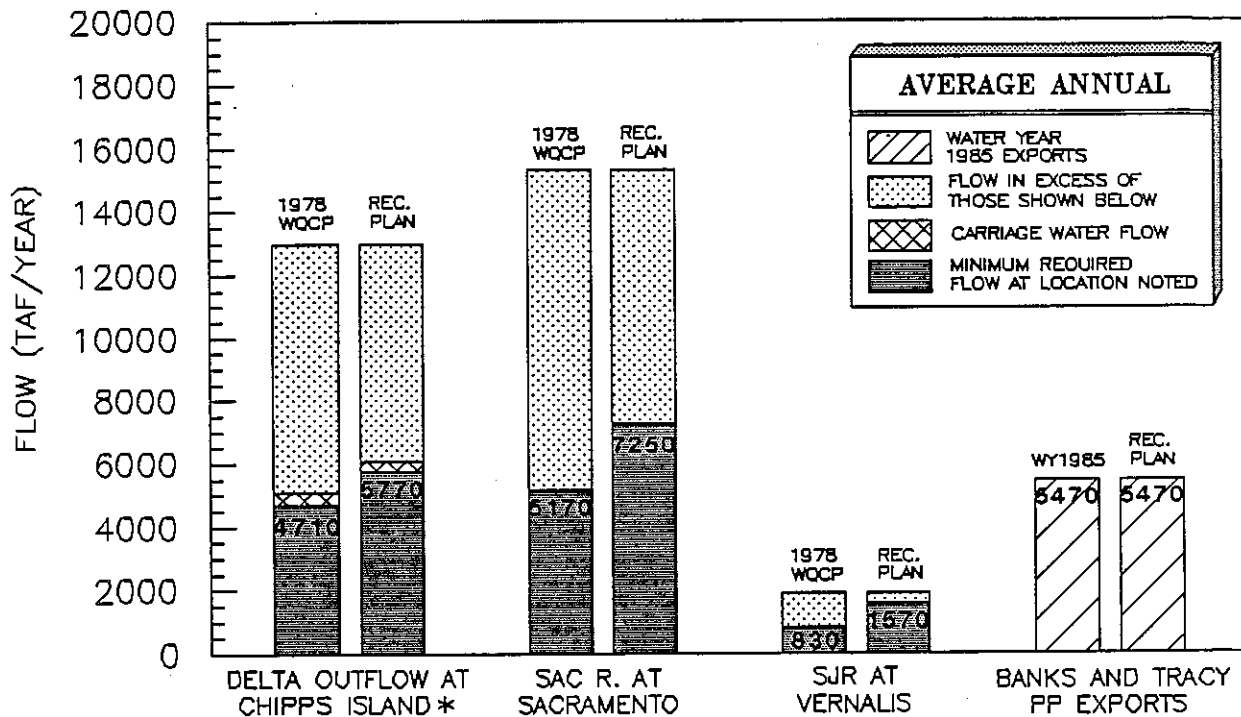

APRIL-JULY

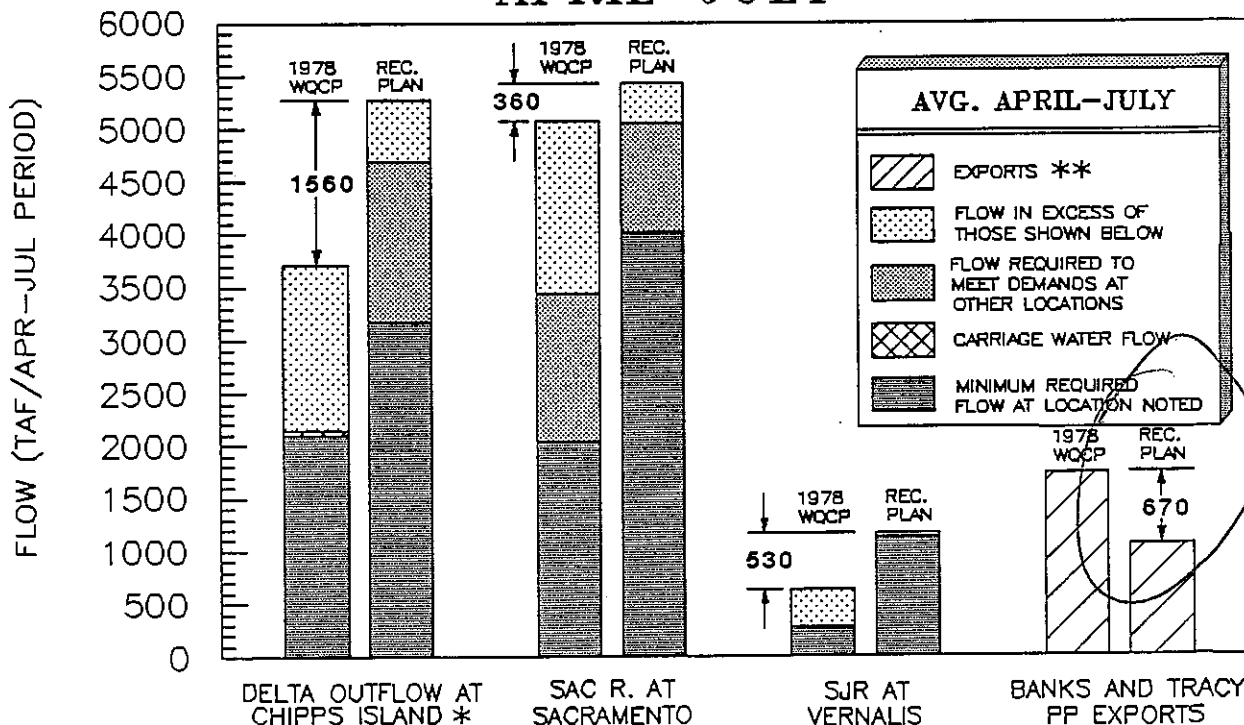

* INCLUDES YOLO BYPASS FLOW

** 1985 EXPORT IMPACT = 680 TAF

FIGURE 7.3.2.7-2 RECOMMENDED PLAN WATER SUPPLY IMPACTS 1972-1987 (W/O 1983) HISTORIC HYDROLOGY AVERAGE ANNUAL

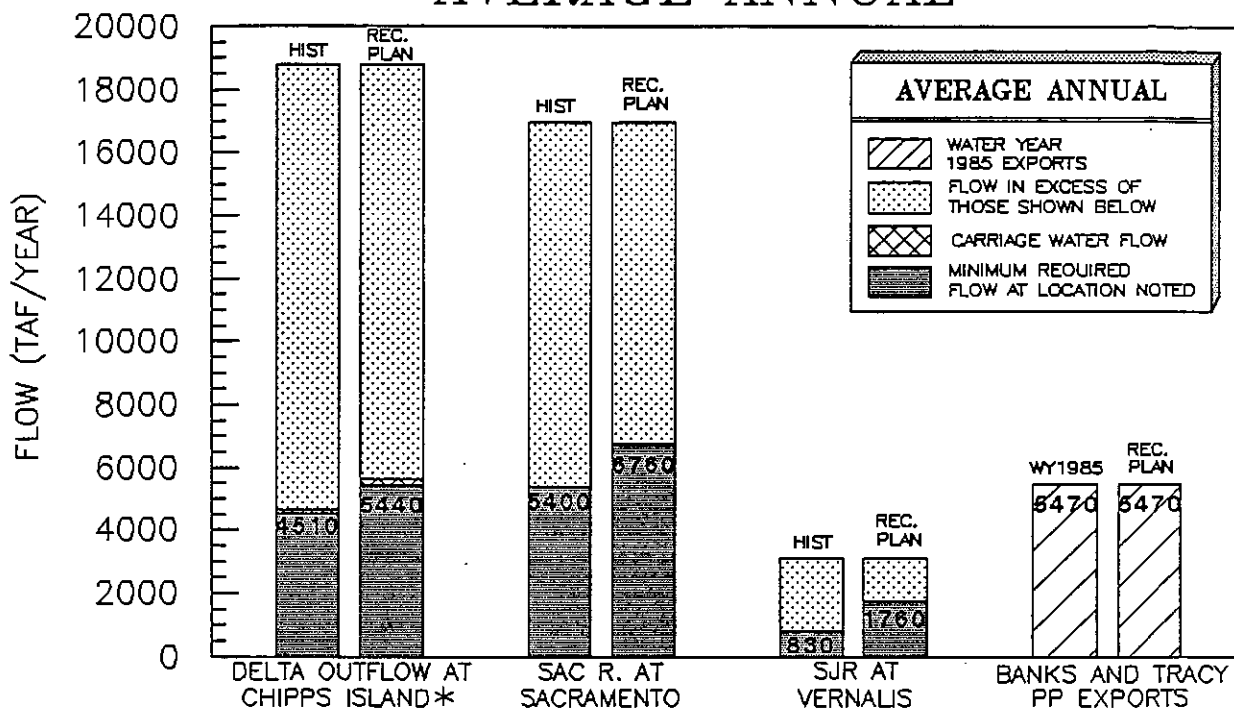

APRIL-JULY

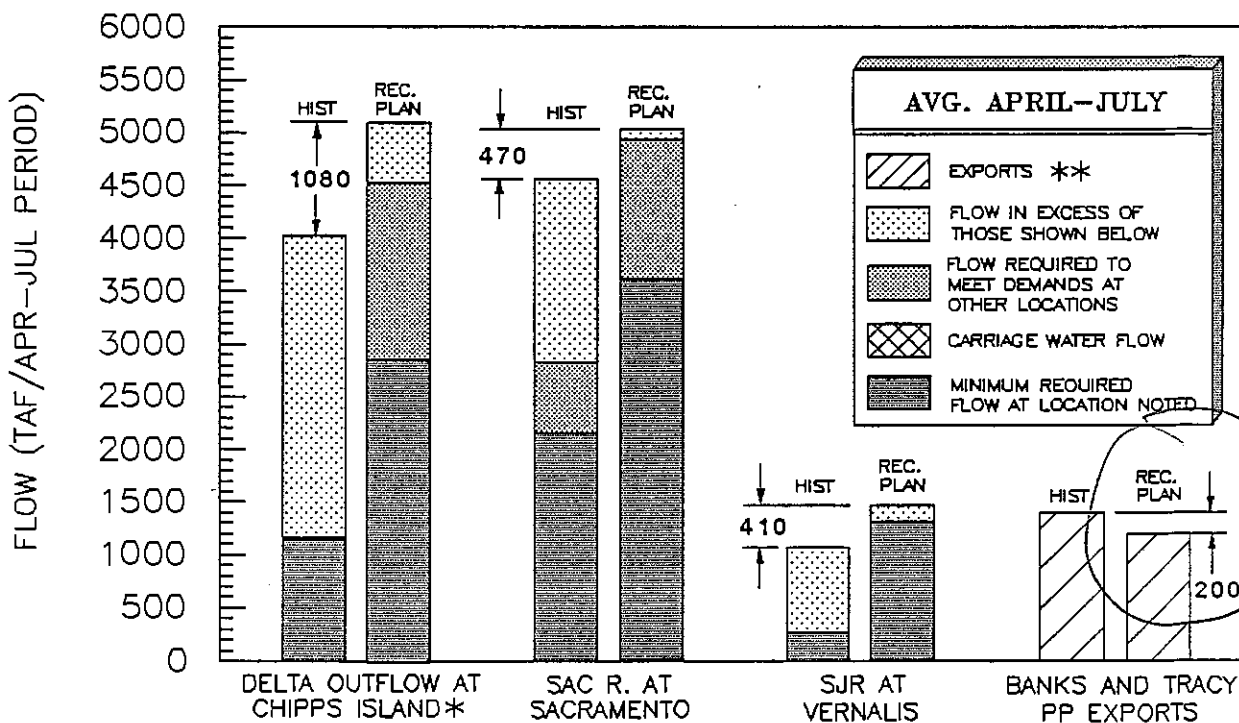

* INCLUDES YOLO BYPASS FLOW

** 1985 EXPORT IMPACT = 540 TAF

8.0 PROGRAM OF IMPLEMENTATION

8.1 Introduction and Discussion of Issues

A Program of Implementation is required in all water quality control plans (WC Section 13242). This chapter provides the program of implementation, and includes: a discussion of how and when the water quality objectives set forth in this Plan are to be implemented; sampling and studies to be performed; and a time schedule.

The Board will use both its water quality and water right authorities to implement the objectives in this Plan. The most controversial aspects of this Plan are related to water rights. Water right issues will actually be determined by the Board during Phase III of the hearing process for the San Francisco Bay/Sacramento-San Joaquin Bay Delta Estuary. To help provide interested parties with an idea of some of the issues that will be discussed fully during Phase III, presented below are some of the concepts and conditions addressed in this Plan as they relate to water right aspects.

8.1.1 Water Right Issues.

8.1.1.1 California Water Ethic

The California water ethic is fully discussed in Chapter 6 of this Plan (see 6.1). The principles developed from this ethic are discussed in sections of chapters 6 and 7 as they relate to determining reasonableness of consumptive use needs (chapter 6) and to determine appropriately balanced objectives for specific beneficial uses (Chapter 7). The Board can consider placing appropriate terms in water right licenses and permits to ensure more efficient use of the state's limited water supply consistent with the California water ethic. In Phase III the Board should consider the following in order to best conserve and utilize Bay-Delta waters:

- The annual combined export quantity per water year from the USBR Tracy Pumping Plant and the SWP Banks Pumping Plant be limited, except that in wet and above normal years, water above that required to meet objectives in the Bay-Delta may be pumped for conjunctive ground water storage and offstream surface storage; and
- The annual amount of water pumped per water year at the SWP Edmonston Pumping Plant for use in the southern California portion of the SWP service area be limited, except that:
(1) an increase above that amount equal to the quantity of water conserved through increased agricultural efficiency in the San Joaquin Valley would be allowed; and (2) in wet and above normal years, water above that required to meet objectives in the Bay-Delta may be pumped for conjunctive ground water storage and offstream surface storage; and
- Agricultural users who contribute drainage flows to salt sinks should achieve a high but reasonably attainable water use efficiency.

8.1.1.2 Sharing the Obligation to Meet Water Quality Objectives in the Estuary

Currently, only certain permits of the CVP and SWP facilities are required to meet Bay-Delta Estuary water quality and flow objectives. These projects represent only about one-half of the almost 30 million acre-feet of water stored within the watershed. The Board will consider an equitable sharing of this responsibility among all users of Bay-Delta Estuary waters during Phase III. One possibility the Board may consider, to create a more equitable sharing, would be to expand the responsibility to maintain Estuary water quality to all reservoirs larger than 100,000 acre-feet. This action would add 31 reservoirs to the list of those assigned this responsibility. Almost 90 percent of the water stored in the watershed would then be operated to help maintain Estuary objectives.

In Water Right Decision 1594, the Board set forth the policy that all new water right permittees should not reduce flows needed to meet Bay-Delta water quality objectives by placing water right terms 91 and 93 into their permits. The Board determined that water for appropriation is no longer available when terms 91 and 93 are in effect. When this occurs new water users must cease diverting. If appropriators use water during this period, they must show the Board evidence that they have another water source being available to them and that they are using that alternative source of supply. Terms 91 and 93 estimate on a real time basis when the CVP and SWP release their stored water to maintain Bay-Delta objectives. During Phase III, the Board may decide if similar terms should be placed in the permits and licenses of existing projects that are not currently operated to maintain water quality objectives in the Estuary. Such actions by the Board would redefine the water right rules upon which the water yield of not only these existing projects but also the water yield of the CVP and SWP are defined. Taking this action may require the phased implementation of the objectives contained in this Plan.

8.1.2 Water Quality Issues

In addition to the concerns, concepts, and analyses discussed in previous chapters which led up to the water quality objectives presented in Chapter 7, an additional issue not addressed heretofore is discussed below.

8.1.2.1 Salt Load Reduction Policy

Two occurrences have degraded water quality in the southern Delta. They are decreases in San Joaquin River flow and increases in salt loads to the river from irrigated agriculture. In this Plan, these flow issues and others are addressed. Upon adoption of this Plan, the State Board should consider requesting the Central Valley Regional Water Quality

Control Board to adopt a salt load reduction policy. The goals of this policy should be to stabilize and to reduce the salt loads discharged into the San Joaquin River. The policy should be achieved through amending existing and new waste discharge requirements, adopting nonpoint source controls, and amending the Basin Plan. The policy should reduce salinity levels to protect beneficial uses.

8.2 Monitoring and Special Studies

A monitoring program is necessary to assess compliance with the water quality objectives of the Water Quality Control Plan and to develop information to refine the water quality objectives in the future. Very little information was presented in Phase I regarding an appropriate monitoring program to be contained in the Water Quality Control Plan. The components of such a monitoring program should include:

- program coordination/data management and reporting
- compliance monitoring
- baseline studies and special studies

Concerns have been raised about the coordination and guidance provided by existing programs and the proper role of the State and Regional Boards in interagency efforts to study various aspects of the Estuary. Specifically, concern has been expressed that the Board's water quality monitoring programs which assess pollutant loads and effects need to be more closely integrated into other interagency studies of the Estuary. Also some groups believe the baseline studies required in D-1485 need to be better integrated into interagency study efforts and made more flexible.

Prior to the 1978 Delta Plan the State and Regional Board's had very little involvement in the interagency study efforts of the Estuary. In D-1485 the State Board required specific new studies of San Francisco Bay be performed. The Board has participated in studies of the Bay by sharing funding of the hydrodynamic element of the San Francisco Bay Program with the Interagency Study Program and by initiating the Aquatic Habitat Program to evaluate pollutant affects on the Bay. However, as discussed in the Pollutant Policy Document, better coordination of State and Regional Board studies on pollutant effects both in and upstream of the Estuary is needed. Consideration should be given for the Board to become a signatory to the Interagency Study Program so that the Board may better coordinate its studies in and upstream of the Estuary with the other agencies. This would include data management and reporting of this information.

This draft plan does not contain a specific baseline study program. The existing program as set forth in the 1978 Delta Plan has not been altered significantly since it was adopted. Baseline studies are necessary to identify long-term trends but they should also be continuously reevaluated and appropriate changes made as required in the 1978 Delta Plan and D-1485. This baseline study program should be reevaluated in Phase II and consideration should be given to merging it more closely with other interagency studies to make it more responsive to special study needs of these programs while still providing an appropriate long-term trend analysis on important parameters.

8.2.1 Compliance Monitoring

A compliance monitoring program will be established during Phase III to assess compliance with the water quality objectives contained in this Plan. The program will include continuous monitoring electrical conductivity recorders at each control station shown on Table 7.3.2.7-1 or a demonstration, to the satisfaction of the Board, that monitoring at a nearby location ensures demonstration of compliance. Funding of this program may be more complex since more parties may be required to help maintain these objectives. In Phase III the cost allocations for such a program will be decided.

8.2.2 Baseline and Special Studies

As stated earlier the baseline program in the 1978 Delta Plan needs to be reevaluated and made more flexible. Information regarding this reevaluation should be presented by the parties in Phase II.

Special studies are a more complex subject. In the 1978 Delta Plan the Board set forth specific special studies to be performed. The goal of these studies were to develop a better understanding of the hydrodynamics, water quality, productivity and significant ecological interactions in the Estuary so that more accurate predictions of the effects of water project operations on beneficial uses could be made. The most significant of these new studies were those in San Francisco and Suisun Bay. Unfortunately, while these studies provided information on the physical effects of flow changes on salinity gradients, phytoplankton production, and fish movement, they did not clearly address how these changes effect beneficial uses like fish and wildlife. Special studies in the San Francisco Bay, Suisun Bay and the Delta should continue to attempt to address this critical information link needed to develop water quality objectives.

Existing studies on the effects on water project operations or salmon and striped bass should continue and new studies to refine our knowledge in this area should be performed. Studies which quantify the effects of water project operations on shad and resident fish should also be performed.

If the State Board were a full member of the interagency study team it could provide more guidance to this group on the type of special studies that are most useful to the Board in setting water quality objectives. After going through the voluminous Phase I hearing record, the Board has identified information gaps that when filled should provide a firmer base upon which to set standards. The Board can help study teams formulate their study plans to gather this missing information.

Funding of baseline and special studies programs in the Estuary should be evaluated in Phase III.

8.3 Legislative Proposals

Although legislation is not required for the implementation of the water quality objectives in this Plan, there are specific areas in which new legislation may be helpful. They are:

- Legislation assisting the Board in implementing the new California water ethic through incentives to increase water conservation, reclamation, and conjunctive ground water and surface water use;
- Legislation to assure the Board's ability to enforce the foregoing recommendations.

New objectives must be implemented in large measure through regulation of water rights. In keeping with the appellate court decision, a much greater universe of water right holders will need to modify their water project operations to help achieve Bay-Delta water quality objectives. These changes in operations will have to be evaluated on a real-time basis in order to assess compliance. As demonstrated during the drought in 1988, the Board has minimal ability to assure compliance by even a small percentage of diverters. Also, increased monitoring and research will be needed to further refine the water quality objectives discussed in preceding sections. In order to achieve an equitable sharing of these responsibilities, the following changes are needed: (1) the water rights administration process should be streamlined to decrease requirements for small projects which have little potential for causing regional or statewide impacts; (2) compliance monitoring of larger projects needs to be automated; and (3) annual users fees should be imposed on permittees and licensees. These fees would be used to help fund the cost of continuing baseline and special studies on the water quality and instream flow needs of the Estuary, and to fund the compliance studies discussed in this Plan.

8.4 Time Schedule

The detailed time schedule for implementation of this Plan will be prepared at the conclusion of Phase III of the hearing process. An appropriate schedule cannot be prepared sooner because the responsibility for implementing various aspects of the Plan will not be addressed until Phase III. However, phased implementation of the objectives should be considered in no more than six years after adoption of this Water Quality Control Plan.



APPENDIX A

Past Proceedings Related to Flow and Salinity
Objectives for the Bay-Dleta Estuary



APPENDIX A -- Past Proceedings Related to Flow and Salinity
Objectives for the Bay-Delta Estuary

Water quality objectives were first proposed for the Delta on November 19, 1965. Water Right Decision 1275 (D-1275) and Decision 1291 adopted in 1967, incorporated these objectives and other terms into the permits issued for the SWP. The State Boards' predecessor agency, the State Water Rights Board, issued a Water Quality Control Policy for the Delta and Suisun Marsh in 1967. This was amended in 1968. Pursuant to commitments made when D-1275 was issued, hearings regarding a salinity standard were initiated in July 1969. Following these hearings, Decision 1379 (D-1379), containing new water quality objectives for the Delta and Suisun Marsh, was issued in July 1971. However, subsequent litigation and court action stayed the implementation of D-1379 so that the requirements of D-1275 remained in effect. Regions 2 and 5 developed interim Basin Plans for their respective parts of the Estuary which were approved by the State Board in 1971. In 1973, in response to EPA concerns regarding the above mentioned 1967 Water Quality Control Policy, the State Board held a hearing and adopted a plan to supplement the 1967 policies. Comprehensive Basin Plans for the Sacramento-San Joaquin Delta Basin (Basin 5B) and the San Francisco Bay Basin (Basin 2), containing long-term water quality objectives, were approved by the State Board in 1975. Most of the water quality objectives incorporated into the Basin Plan for Basin 5B were similar to those of D-1379. In 1976 the State Board initiated a joint water quality and water right hearing to coordinate salinity objectives for the Delta and Suisun Marsh. This resulted, in 1978, in adoption by the State Board of the Water Quality Control Plan for the Sacramento-San Joaquin Delta and Suisun Marsh (Delta Plan) and Water Right Decision 1485 (D-1485). The Delta Plan contained flow and salinity objectives superseding those in the 5B Basin Plan. D-1485 placed permit conditions on the SWP and CVP to achieve salinity objectives in the Delta and Suisun Marsh through regulation of flows and operational constraints. In November 1983, the State Board adopted Water Right Decision 1594 pursuant to its reserved jurisdiction over more than 500 permittees in the Sacramento-San Joaquin Delta watershed. This decision placed conditions on permits issued since 1965, other than SWP and CVP, generally prohibiting diversions when natural and abandoned flows are insufficient to meet the D-1485 Delta water quality objectives. Under insufficient flow conditions the SWP and CVP have to release stored water to meet the objectives contained in D-1485.



APPENDIX B

DAYFLOW and Salmon Survival Data Sets

The following tables, B1 - B12, provide the flow data from DWR's DAYFLOW program which were used to calculate fishery protection levels and average historical conditions. Also included is the Sacramento River (Rio Vista) Estimated Salmon Survival Index. Year type classifications are the proposed April - July water year types as defined in the Draft Plan. Sacramento Valley year types are used throughout except for Delta exports and Vernalis (San Joaquin River) inflow, which use San Joaquin Valley year types. The effects of Delta island flooding and dewatering are discounted from the export values.

List of Tables

- B-1 Sacramento Valley April - July Inflow, 1953 - 1987
- B-2 Sacramento Valley April - July Inflow, 1953 - 1987, Year Type Summary
- B-3 Rio Vista April - June Flow, 1930 - 1987 (with and without a cap of 22,500 cfs on flow)
- B-4 Rio Vista April - June Flow, 1930 - 1987, Year Type Summary (with cap of 22,500 cfs on flow) and Estimated Salmon Survival Index [3 pages]
- B-5 Rio Vista April - June Year Type Summary of Various Historical Periods
- B-6 Vernalis April - June Inflow, 1930 - 1987 (with and without a cap of 20,000 cfs on flow)
- B-7 Vernalis April - June Inflow, 1930 - 1987, Year Type Summary
- B-8 Total Annual Delta Exports, 1950 - 1987
- B-9 Total April - July Delta Exports, 1953 - 1987
- B-10 Total April - July Delta Exports, 1953 - 1987, Year Type Summary
- B-11 Delta Outflow, April - July, 1953 - 1987
- B-12 Delta Outflow, April - July, 1953 - 1987, Year Type Summary



SACRAMENTO VALLEY HISTORIC FLOWS - CFS
(SACRAMENTO RIVER PLUS YOLO BYPASS) 1953-1987
FROM DAYFLOW

| WATER YR. | YR. | TYPE | APR | MAY | JUN | JUL | AVG |
|-----------|-----|------|---------|--------|--------|--------|--------|
| 1953 | | W | 30,093 | 36,809 | 31,637 | 11,193 | 27,433 |
| 1954 | | AN | 52,972 | 25,086 | 11,508 | 8,100 | 24,417 |
| 1955 | | BN | 13,446 | 20,947 | 12,054 | 9,145 | 13,898 |
| 1956 | | W | 32,506 | 43,788 | 25,660 | 12,413 | 28,592 |
| 1957 | | BN | 20,040 | 31,856 | 16,871 | 9,353 | 19,530 |
| 1958 | | W | 109,618 | 54,717 | 35,825 | 14,502 | 53,666 |
| 1959 | | D | 13,964 | 11,435 | 8,030 | 10,562 | 10,998 |
| 1960 | | D | 19,331 | 16,123 | 10,900 | 10,428 | 14,196 |
| 1961 | | D | 17,037 | 13,160 | 10,965 | 10,558 | 12,930 |
| 1962 | | BN | 28,359 | 19,823 | 13,066 | 10,262 | 17,878 |
| 1963 | | W | 87,081 | 43,835 | 17,736 | 12,183 | 40,209 |
| 1964 | | D | 12,538 | 13,970 | 11,166 | 11,639 | 12,328 |
| 1965 | | W | 44,476 | 30,249 | 16,085 | 12,155 | 25,741 |
| 1966 | | BN | 21,778 | 14,237 | 9,608 | 11,588 | 14,303 |
| 1967 | | W | 55,513 | 53,324 | 44,511 | 19,520 | 43,217 |
| 1968 | | D | 14,719 | 13,367 | 11,380 | 12,597 | 13,016 |
| 1969 | | W | 46,420 | 41,299 | 23,271 | 14,248 | 31,310 |
| 1970 | | D | 14,743 | 14,312 | 11,820 | 13,190 | 13,516 |
| 1971 | | W | 39,121 | 29,779 | 27,734 | 20,995 | 29,407 |
| 1972 | | BN | 13,126 | 12,856 | 13,854 | 15,002 | 13,710 |
| 1973 | | BN | 21,338 | 16,505 | 14,974 | 15,182 | 17,000 |
| 1974 | | W | 103,780 | 29,351 | 24,464 | 21,776 | 44,843 |
| 1975 | | W | 34,889 | 30,551 | 23,738 | 18,297 | 26,869 |
| 1976 | | C | 12,724 | 10,950 | 10,936 | 12,077 | 11,672 |
| 1977 | | C | 5,962 | 7,598 | 6,866 | 8,249 | 7,169 |
| 1978 | | AN | 40,261 | 25,215 | 12,677 | 14,317 | 23,118 |
| 1979 | | BN | 16,577 | 18,015 | 12,225 | 16,428 | 15,811 |
| 1980 | | BN | 22,643 | 15,930 | 17,842 | 17,753 | 18,542 |
| 1981 | | C | 17,256 | 13,802 | 10,747 | 15,311 | 14,279 |
| 1982 | | W | 114,798 | 42,674 | 26,126 | 17,662 | 50,315 |
| 1983 | | W | 78,419 | 65,822 | 49,486 | 31,040 | 56,192 |
| 1984 | | BN | 18,266 | 15,470 | 15,028 | 21,653 | 17,604 |
| 1985 | | D | 12,495 | 13,432 | 13,310 | 16,035 | 13,818 |
| 1986 | | BN | 26,978 | 12,804 | 11,863 | 16,924 | 17,142 |
| 1987 | | C | 11,872 | 10,039 | 10,110 | 15,185 | 11,802 |

SACRAMENTO VALLEY FLOWS (SACRAMENTO R. + YOLO BYPASS) - CFS
 YEAR TYPE SUMMARY FROM DAYFLOW
 1953-1967

| WATER YR. | YR. TYPE | APR | MAY | JUN | JUL | AVG |
|-----------|----------|--------|--------|--------|--------|--------|
| AVERAGE | W(6) | 59,881 | 43,787 | 28,576 | 13,661 | 36,476 |
| 1954 | AN(1) | 52,972 | 25,086 | 11,508 | 8,100 | 24,417 |
| AVERAGE | BN(4) | 20,906 | 21,716 | 12,900 | 10,087 | 16,402 |
| AVERAGE | D(4) | 15,718 | 13,672 | 10,265 | 10,797 | 12,613 |
| - | C(0) | - | - | - | - | - |
| GRND MEAN | 15 | 37,369 | 26,065 | 15,812 | 10,661 | 22,477 |
| WTDGNDMN | 15 | 37,250 | 28,624 | 18,375 | 11,573 | 23,956 |

1968-1987

| WATER YR. | YR. TYPE | APR | MAY | JUN | JUL | AVG |
|-----------|----------|--------|--------|--------|--------|--------|
| AVERAGE | W(6) | 69,571 | 39,913 | 29,137 | 20,670 | 39,823 |
| 1978 | AN(1) | 40,261 | 25,215 | 12,677 | 14,317 | 23,118 |
| AVERAGE | BN(6) | 19,821 | 15,263 | 14,298 | 17,157 | 16,635 |
| AVERAGE | D(3) | 13,986 | 13,704 | 12,170 | 13,941 | 13,450 |
| AVERAGE | C(4) | 11,954 | 10,597 | 9,665 | 12,706 | 11,230 |
| GRND MEAN | 20 | 31,119 | 20,938 | 15,589 | 15,758 | 20,851 |
| WGTGNDMN | 20 | 33,319 | 21,989 | 17,423 | 16,696 | 22,357 |

1979-1987

| WATER YR. | YR. TYPE | APR | MAY | JUN | JUL | AVERAGE |
|-----------|----------|--------|--------|--------|--------|---------|
| AVERAGE | W(2) | 96,609 | 54,248 | 37,806 | 24,351 | 53,253 |
| - | AN(0) | - | - | - | - | - |
| AVERAGE | BN(4) | 21,116 | 15,555 | 14,240 | 18,190 | 17,275 |
| 1985 | D(1) | 12,495 | 13,432 | 13,310 | 16,035 | 13,818 |
| AVERAGE | C(2) | 14,564 | 11,921 | 10,429 | 15,248 | 13,040 |
| GRND MEAN | 9 | 36,196 | 23,789 | 18,946 | 18,456 | 24,347 |
| WTDGNDMN | 9 | 35,478 | 23,110 | 18,526 | 18,666 | 23,945 |

1953-1987

| WATER YR. | YR. TYPE | APR | MAY | JUN | JUL | AVG |
|-----------|----------|--------|--------|--------|--------|--------|
| AVERAGE | W(12) | 64,726 | 41,850 | 28,856 | 17,165 | 38,149 |
| AVERAGE | AN(2) | 46,617 | 25,151 | 12,093 | 11,209 | 23,767 |
| AVERAGE | BN(10) | 20,255 | 17,844 | 13,739 | 14,329 | 16,542 |
| AVERAGE | D(7) | 14,975 | 13,686 | 11,082 | 12,144 | 12,972 |
| AVERAGE | C(4) | 11,954 | 10,597 | 9,665 | 12,706 | 11,230 |
| GRND MEAN | 35 | 31,705 | 21,825 | 15,087 | 13,510 | 20,532 |
| WTDGNDMN | 35 | 35,004 | 24,832 | 17,831 | 14,501 | 23,042 |

 GRND MEAN = AVERAGE OF ALL YEARS IN GROUP
 WTDGNDMN = AVERAGE OF ALL YEARS IN GROUP WEIGHTED BY FREQUENCY OF EACH YEAR TYPE IN GROUP

RIO VISTA FLOWS, 1930-1987
(From DWR DAYFLOW)

AVERAGE MONTHLY RIO VISTA FLOW, 1930-1987
(Maximum set to 22,500 cfs)
(from DWR DAYFLOW)

| YEAR | YR TYPE | APR Q | MAY Q | JUNE Q | AVG Q | YEAR | YR TYPE | APR Q | MAY Q | JUNE Q | AVG Q |
|----------------|---------|--------|-------|--------|-------|----------------|---------|-------|-------|--------|-------|
| 1930 | D | 27171 | 16841 | 6392 | 16801 | 1930 | D | 22500 | 16841 | 6392 | 15244 |
| 1931 | C | 6070 | 3068 | 349 | 3162 | 1931 | C | 6070 | 3068 | 349 | 3162 |
| 1932 | D | 23686 | 29274 | 14925 | 22628 | 1932 | D | 22500 | 22500 | 14925 | 19975 |
| 1933 | D | 18694 | 16171 | 12255 | 15707 | 1933 | D | 18694 | 16171 | 12255 | 15707 |
| 1934 | C | 13762 | 5155 | 1590 | 6836 | 1934 | C | 13762 | 5155 | 1590 | 6836 |
| 1935 | W | 79218 | 40679 | 16114 | 45337 | 1935 | W | 22500 | 22500 | 16114 | 20371 |
| 1936 | AN | 38447 | 24393 | 14512 | 25784 | 1936 | AN | 22500 | 22500 | 14512 | 19837 |
| 1937 | AN | 46085 | 33492 | 12217 | 30598 | 1937 | AN | 22500 | 22500 | 12217 | 19072 |
| 1938 | W | 83013 | 72068 | 37227 | 64103 | 1938 | W | 22500 | 22500 | 22500 | 22500 |
| 1939 | C | 14650 | 5668 | 916 | 7078 | 1939 | C | 14650 | 5668 | 916 | 7078 |
| 1940 | AN | 94517 | 25834 | 8923 | 43091 | 1940 | AN | 22500 | 22500 | 8923 | 17974 |
| 1941 | W | 92744 | 84952 | 50901 | 76199 | 1941 | W | 22500 | 22500 | 22500 | 22500 |
| 1942 | W | 64020 | 46344 | 29054 | 46473 | 1942 | W | 22500 | 22500 | 22500 | 22500 |
| 1943 | AN | 46645 | 25534 | 12415 | 28198 | 1943 | AN | 22500 | 22500 | 12415 | 19138 |
| 1944 | BN | 14454 | 19045 | 6689 | 13396 | 1944 | BN | 14454 | 19045 | 6689 | 13396 |
| 1945 | BN | 22542 | 21745 | 11063 | 18450 | 1945 | BN | 22500 | 21745 | 11063 | 18436 |
| 1946 | BN | 27988 | 22276 | 8786 | 19683 | 1946 | BN | 22500 | 22276 | 8786 | 17854 |
| 1947 | D | 18509 | 7536 | 5350 | 10465 | 1947 | D | 18509 | 7536 | 5350 | 10465 |
| 1948 | W | 46700 | 44333 | 26828 | 39287 | 1948 | W | 22500 | 22500 | 22500 | 22500 |
| 1949 | BN | 25825 | 19262 | 6574 | 17220 | 1949 | BN | 22500 | 19262 | 6574 | 16112 |
| 1950 | AN | 30215 | 23779 | 12852 | 22282 | 1950 | AN | 22500 | 22500 | 12852 | 19284 |
| 1951 | BN | 21406 | 22176 | 7023 | 16868 | 1951 | BN | 21406 | 22176 | 7023 | 16868 |
| 1952 | W | 69015 | 63542 | 33756 | 55438 | 1952 | W | 22500 | 22500 | 22500 | 22500 |
| 1953 | W | 20947 | 25223 | 20307 | 22159 | 1953 | W | 20947 | 22500 | 20307 | 21251 |
| 1954 | AN | 36875 | 16927 | 8247 | 20683 | 1954 | AN | 22500 | 16927 | 8247 | 15891 |
| 1955 | BN | 11231 | 17076 | 8597 | 12301 | 1955 | BN | 11231 | 17076 | 8597 | 12301 |
| 1956 | W | 27375 | 36915 | 20392 | 28227 | 1956 | W | 22500 | 22500 | 20392 | 21797 |
| 1957 | BN | 12753 | 24266 | 10880 | 15966 | 1957 | BN | 12753 | 22500 | 10880 | 15378 |
| 1958 | W | 100201 | 46283 | 29308 | 58597 | 1958 | W | 22500 | 22500 | 22500 | 22500 |
| 1959 | D | 7569 | 5319 | 2542 | 5143 | 1959 | D | 7569 | 5319 | 2542 | 5143 |
| 1960 | D | 11337 | 8768 | 4577 | 8227 | 1960 | D | 11337 | 8768 | 4577 | 8227 |
| 1961 | D | 9677 | 6598 | 4645 | 6973 | 1961 | D | 9677 | 6598 | 4645 | 6973 |
| 1962 | BN | 17544 | 11366 | 6115 | 11675 | 1962 | BN | 17544 | 11366 | 6115 | 11675 |
| 1963 | W | 78676 | 36897 | 10514 | 42029 | 1963 | W | 22500 | 22500 | 10514 | 18505 |
| 1964 | D | 6344 | 7205 | 4999 | 6183 | 1964 | D | 6344 | 7205 | 4999 | 6183 |
| 1965 | W | 36728 | 24180 | 8253 | 23054 | 1965 | W | 22500 | 22500 | 8253 | 17751 |
| 1966 | BN | 14142 | 7387 | 3667 | 8399 | 1966 | BN | 14142 | 7387 | 3667 | 8399 |
| 1967 | W | 48585 | 44945 | 36663 | 43398 | 1967 | W | 22500 | 22500 | 22500 | 22500 |
| 1968 | D | 7988 | 6733 | 4914 | 6545 | 1968 | D | 7988 | 6733 | 4914 | 6545 |
| 1969 | W | 39290 | 34409 | 15475 | 29725 | 1969 | W | 22500 | 22500 | 15475 | 20158 |
| 1970 | D | 7979 | 7368 | 5265 | 6871 | 1970 | D | 7979 | 7368 | 5265 | 6871 |
| 1971 | W | 32692 | 21483 | 16533 | 23569 | 1971 | W | 22500 | 21483 | 16533 | 20172 |
| 1972 | BN | 6915 | 6345 | 6710 | 6657 | 1972 | BN | 6915 | 6345 | 6710 | 6657 |
| 1973 | BN | 13397 | 9454 | 8589 | 10480 | 1973 | BN | 13397 | 9454 | 8589 | 10480 |
| 1974 | W | 94216 | 18732 | 14241 | 42396 | 1974 | W | 22500 | 18732 | 14241 | 18491 |
| 1975 | W | 25744 | 18912 | 13658 | 19438 | 1975 | W | 22500 | 18912 | 13658 | 18357 |
| 1976 | C | 6814 | 4981 | 4602 | 5466 | 1976 | C | 6814 | 4981 | 4602 | 5466 |
| 1977 | C | 1615 | 2990 | 1791 | 2132 | 1977 | C | 1615 | 2990 | 1791 | 2132 |
| 1978 | AN | 34486 | 16697 | 5829 | 19004 | 1978 | AN | 22500 | 16697 | 5829 | 15009 |
| 1979 | BN | 11738 | 9996 | 5509 | 9081 | 1979 | BN | 11738 | 9996 | 5509 | 9081 |
| 1980 | BN | 17896 | 11775 | 10488 | 13386 | 1980 | BN | 17896 | 11775 | 10488 | 13386 |
| 1981 | C | 12321 | 7718 | 4464 | 8168 | 1981 | C | 12321 | 7718 | 4464 | 8168 |
| 1982 | W | 104470 | 35529 | 18953 | 52984 | 1982 | W | 22500 | 22500 | 18953 | 21318 |
| 1983 | W | 69581 | 56419 | 41173 | 55724 | 1983 | W | 22500 | 22500 | 22500 | 22500 |
| 1984 | BN | 13515 | 9305 | 7497 | 10106 | 1984 | BN | 13515 | 9305 | 7497 | 10106 |
| 1985 | D | 6303 | 7197 | 6946 | 6815 | 1985 | D | 6303 | 7197 | 6946 | 6815 |
| 1986 | BN | 22650 | 8605 | 5261 | 12172 | 1986 | BN | 22500 | 8605 | 5261 | 12122 |
| 1987 | C | 6008 | 4972 | 4002 | 4994 | 1987 | C | 6008 | 4972 | 4002 | 4994 |
| ----- | | | | | | | | | | | |
| AVG 30-52 | | 40234 | 29268 | 14640 | 28047 | AVG 30-52 | | 20328 | 18650 | 11802 | 16927 |
| AVG 53-87 | | 27874 | 17685 | 10903 | 18821 | AVG 53-87 | | 15401 | 13683 | 9770 | 12951 |
| AVG 30-87 | | 32775 | 22278 | 12385 | 22480 | AVG 30-87 | | 17355 | 15653 | 10576 | 14528 |
| AVG 53-67 | | 29332 | 21290 | 11980 | 20868 | AVG 53-67 | | 16436 | 15876 | 10582 | 14298 |
| AVG 68-78 | | 24649 | 13464 | 8873 | 15662 | AVG 68-78 | | 14292 | 12381 | 8873 | 11849 |
| AVG 79-87 | | 29387 | 16835 | 11588 | 19270 | AVG 79-87 | | 15031 | 11619 | 9513 | 12054 |
| AVG 72-87 | | 27979 | 14352 | 9982 | 17438 | AVG 72-87 | | 14470 | 11417 | 8815 | 11568 |
| AVG 72-87(-83) | | 25206 | 11547 | 7903 | 14885 | AVG 72-87(-83) | | 13935 | 10679 | 7903 | 10839 |

RIO VISTA FLOWS, 1930-1987
 (From DWR DAYFLOW)
 (Maximum flow = 22,500cfs)

SALMON SMOLT SURVIVAL 1/

| YR | APR | MAY | JUN | YR | APR | MAY | JUN | AVG | WEIGHTED |
|-----------|-------|-------|-------|-----------|------|------|------|------|-------------------|
| YEAR | Q | Q | Q | YEAR | S | S | S | S | SURVIVAL |
| 1935 W | 22500 | 22500 | 16114 | 1935 W | 1.00 | 1.00 | 0.64 | 0.88 | Survival=average |
| 1938 W | 22500 | 22500 | 22500 | 1938 W | 1.00 | 1.00 | 1.00 | 1.00 | Apr.-Jun survival |
| 1941 W | 22500 | 22500 | 22500 | 1941 W | 1.00 | 1.00 | 1.00 | 1.00 | * year type |
| 1942 W | 22500 | 22500 | 22500 | 1942 W | 1.00 | 1.00 | 1.00 | 1.00 | frequency |
| 1948 W | 22500 | 22500 | 22500 | 1948 W | 1.00 | 1.00 | 1.00 | 1.00 | |
| 1952 W | 22500 | 22500 | 22500 | 1952 W | 1.00 | 1.00 | 1.00 | 1.00 | |
| 1953 W | 20947 | 22500 | 20307 | 1953 W | 0.92 | 1.00 | 0.88 | 0.93 | |
| 1956 W | 22500 | 22500 | 20392 | 1956 W | 1.00 | 1.00 | 0.88 | 0.96 | |
| 1958 W | 22500 | 22500 | 22500 | 1958 W | 1.00 | 1.00 | 1.00 | 1.00 | |
| 1963 W | 22500 | 22500 | 10514 | 1963 W | 1.00 | 1.00 | 0.33 | 0.78 | |
| 1965 W | 22500 | 22500 | 8253 | 1965 W | 1.00 | 1.00 | 0.20 | 0.74 | |
| 1967 W | 22500 | 22500 | 22500 | 1967 W | 1.00 | 1.00 | 1.00 | 1.00 | |
| 1969 W | 22500 | 22500 | 15475 | 1969 W | 1.00 | 1.00 | 0.61 | 0.87 | |
| 1971 W | 22500 | 21483 | 16533 | 1971 W | 1.00 | 0.95 | 0.67 | 0.87 | |
| 1974 W | 22500 | 18732 | 14241 | 1974 W | 1.00 | 0.79 | 0.54 | 0.78 | |
| 1975 W | 22500 | 18912 | 13658 | 1975 W | 1.00 | 0.80 | 0.51 | 0.77 | |
| 1982 W | 22500 | 22500 | 18953 | 1982 W | 1.00 | 1.00 | 0.80 | 0.94 | |
| 1983 W | 22500 | 22500 | 22500 | 1983 W | 1.00 | 1.00 | 1.00 | 1.00 | |
| ----- | | | | | | | | | |
| 30-87 AVG | 22414 | 22035 | 18580 | 30-87 AVG | 1.00 | 0.98 | 0.78 | 0.92 | 0.29 |
| 53-87 AVG | 22371 | 21802 | 17152 | 53-87 AVG | 0.99 | 0.96 | 0.70 | 0.89 | 0.30 |
| 30-52 AVG | 22500 | 22500 | 21436 | 30-52 AVG | 1.00 | 1.00 | 0.94 | 0.98 | 0.25 |
| ----- | | | | | | | | | |
| 1936 AN | 22500 | 22500 | 14512 | 1936 AN | 1.00 | 1.00 | 0.55 | 0.85 | |
| 1937 AN | 22500 | 22500 | 12217 | 1937 AN | 1.00 | 1.00 | 0.43 | 0.81 | |
| 1940 AN | 22500 | 22500 | 8923 | 1940 AN | 1.00 | 1.00 | 0.24 | 0.75 | |
| 1943 AN | 22500 | 22500 | 12415 | 1943 AN | 1.00 | 1.00 | 0.44 | 0.81 | |
| 1950 AN | 22500 | 22500 | 12852 | 1950 AN | 1.00 | 1.00 | 0.46 | 0.82 | |
| 1954 AN | 22500 | 16927 | 8247 | 1954 AN | 1.00 | 0.69 | 0.20 | 0.63 | |
| 1978 AN | 22500 | 16697 | 5829 | 1978 AN | 1.00 | 0.68 | 0.07 | 0.58 | |
| ----- | | | | | | | | | |
| 30-87 AVG | 22500 | 20875 | 10714 | 30-87 AVG | 1.00 | 0.91 | 0.34 | 0.75 | 0.09 |
| 53-87 AVG | 22500 | 16812 | 7038 | 53-87 AVG | 1.00 | 0.68 | 0.14 | 0.61 | 0.04 |
| 30-52 AVG | 22500 | 22500 | 12184 | 30-52 AVG | 1.00 | 1.00 | 0.42 | 0.81 | 0.18 |

B-4-1

| | | | | | | | | |
|---------|-------|-------|-------|---------|------|------|------|------|
| 1944 BN | 14454 | 19045 | 6689 | 1944 BN | 0.55 | 0.81 | 0.12 | 0.49 |
| 1945 BN | 22500 | 21745 | 11063 | 1945 BN | 1.00 | 0.96 | 0.36 | 0.77 |
| 1946 BN | 22500 | 22276 | 8786 | 1946 BN | 1.00 | 0.99 | 0.23 | 0.74 |
| 1949 BN | 22500 | 19262 | 6574 | 1949 BN | 1.00 | 0.82 | 0.11 | 0.64 |
| 1951 BN | 21406 | 22176 | 7023 | 1951 BN | 0.94 | 0.98 | 0.14 | 0.69 |
| 1955 BN | 11231 | 17076 | 8597 | 1955 BN | 0.37 | 0.70 | 0.22 | 0.43 |
| 1957 BN | 12753 | 22500 | 10880 | 1957 BN | 0.46 | 1.00 | 0.35 | 0.60 |
| 1962 BN | 17544 | 11366 | 6115 | 1962 BN | 0.72 | 0.38 | 0.08 | 0.40 |
| 1966 BN | 14142 | 7387 | 3667 | 1966 BN | 0.53 | 0.16 | 0.00 | 0.23 |
| 1972 BN | 6915 | 6345 | 6710 | 1972 BN | 0.13 | 0.10 | 0.12 | 0.11 |
| 1973 BN | 13397 | 9454 | 8589 | 1973 BN | 0.49 | 0.27 | 0.22 | 0.33 |
| 1979 BN | 11738 | 9996 | 5509 | 1979 BN | 0.40 | 0.30 | 0.05 | 0.25 |
| 1980 BN | 17896 | 11775 | 10488 | 1980 BN | 0.74 | 0.40 | 0.33 | 0.49 |
| 1984 BN | 13515 | 9305 | 7497 | 1984 BN | 0.50 | 0.26 | 0.16 | 0.31 |
| 1986 BN | 22500 | 8605 | 5261 | 1986 BN | 1.00 | 0.22 | 0.04 | 0.42 |

| | | | | | | | | | |
|-----------|-------|-------|------|-----------|------|------|------|------|------|
| 30-87 AVG | 16333 | 14554 | 7563 | 30-87 AVG | 0.66 | 0.56 | 0.17 | 0.46 | 0.12 |
| 53-87 AVG | 14163 | 11381 | 7331 | 53-87 AVG | 0.54 | 0.38 | 0.16 | 0.36 | 0.10 |
| 30-52 AVG | 20672 | 20901 | 8027 | 30-52 AVG | 0.90 | 0.91 | 0.19 | 0.67 | 0.15 |

| | | | | | | | | |
|--------|-------|-------|-------|--------|------|------|------|------|
| 1930 D | 22500 | 16841 | 6392 | 1930 D | 1.00 | 0.69 | 0.10 | 0.60 |
| 1932 D | 22500 | 22500 | 14925 | 1932 D | 1.00 | 1.00 | 0.58 | 0.86 |
| 1933 D | 18694 | 16171 | 12255 | 1933 D | 0.79 | 0.65 | 0.43 | 0.62 |
| 1947 D | 18509 | 7536 | 5350 | 1947 D | 0.78 | 0.16 | 0.04 | 0.33 |
| 1959 D | 7569 | 5319 | 2542 | 1959 D | 0.17 | 0.04 | 0.00 | 0.07 |
| 1960 D | 11337 | 8768 | 4577 | 1960 D | 0.38 | 0.23 | 0.00 | 0.20 |
| 1961 D | 9677 | 6598 | 4645 | 1961 D | 0.28 | 0.11 | 0.00 | 0.13 |
| 1964 D | 6344 | 7205 | 4999 | 1964 D | 0.10 | 0.15 | 0.02 | 0.09 |
| 1968 D | 7988 | 6733 | 4914 | 1968 D | 0.19 | 0.12 | 0.02 | 0.11 |
| 1970 D | 7979 | 7368 | 5265 | 1970 D | 0.19 | 0.15 | 0.04 | 0.13 |
| 1985 D | 6303 | 7197 | 6946 | 1985 D | 0.09 | 0.15 | 0.13 | 0.12 |

| | | | | | | | | | |
|-----------|-------|-------|------|-----------|------|------|------|------|------|
| 30-87 AVG | 12673 | 10203 | 6619 | 30-87 AVG | 0.45 | 0.31 | 0.12 | 0.30 | 0.06 |
| 53-87 AVG | 8171 | 7027 | 4841 | 53-87 AVG | 0.20 | 0.14 | 0.03 | 0.12 | 0.02 |
| 30-52 AVG | 20551 | 15762 | 9731 | 30-52 AVG | 0.89 | 0.62 | 0.29 | 0.60 | 0.10 |

B-4-2

| | | | | | | | | | |
|-----------|-------|------|------|-----------|------|------|------|------|------|
| 1931 C | 6070 | 3068 | 349 | 1931 C | 0.08 | 0.00 | 0.00 | 0.03 | |
| 1934 C | 13762 | 5155 | 1590 | 1934 C | 0.51 | 0.03 | 0.00 | 0.18 | |
| 1939 C | 14650 | 5668 | 916 | 1939 C | 0.56 | 0.06 | 0.00 | 0.21 | |
| 1976 C | 6814 | 4981 | 4602 | 1976 C | 0.12 | 0.02 | 0.00 | 0.05 | |
| 1977 C | 1615 | 2990 | 1791 | 1977 C | 0.00 | 0.00 | 0.00 | 0.00 | |
| 1981 C | 12321 | 7718 | 4464 | 1981 C | 0.43 | 0.17 | 0.00 | 0.20 | |
| 1987 C | 6008 | 4972 | 4002 | 1987 C | 0.08 | 0.02 | 0.00 | 0.03 | |
| ----- | | | | | | | | | |
| 30-87 AVG | 8749 | 4936 | 2531 | 30-87 AVG | 0.26 | 0.04 | 0.00 | 0.10 | 0.01 |
| 53-87 AVG | 6690 | 5165 | 3715 | 53-87 AVG | 0.16 | 0.05 | 0.00 | 0.07 | 0.01 |
| 30-52 AVG | 11494 | 4630 | 952 | 30-52 AVG | 0.39 | 0.03 | 0.00 | 0.14 | 0.02 |

TOTAL WEIGHTED SURVIVAL, 1930-1987: 0.57
TOTAL WEIGHTED SURVIVAL, 1953-1987: 0.47
TOTAL WEIGHTED SURVIVAL, 1930-1952: 0.70

1/ Survival=(Rio Vista flow * .000056)-.258. From USFWS,31.

AVERAGE SURVIVAL, 1930-1987: 0.51
AVERAGE SURVIVAL, 1953-1987: 0.41
AVERAGE SURVIVAL, 1930-1952: 0.64

RIO VISTA FLOWS, 1930-1987
(From DWR DAYFLOW)

| YEAR | YR TYPE | APR Q | MAY Q | JUNE Q | YEAR | YR TYPE | APR Q | MAY Q |
|-------|---------|--------|-------|--------|-------|---------|-------|-------|
| 1935 | W | 79218 | 40679 | 16114 | 1930 | D | 27171 | 16841 |
| 1938 | W | 83013 | 72068 | 37227 | 1932 | D | 23686 | 29274 |
| 1941 | W | 92744 | 84952 | 50901 | 1933 | D | 18694 | 16171 |
| 1942 | W | 64020 | 46344 | 29054 | 1947 | D | 18509 | 7536 |
| 1948 | W | 46700 | 44333 | 26828 | 1959 | D | 7569 | 5319 |
| 1952 | W | 69015 | 63542 | 33756 | 1960 | D | 11337 | 8768 |
| 1953 | W | 20947 | 25223 | 20307 | 1961 | D | 9677 | 6598 |
| 1956 | W | 27375 | 36915 | 20392 | 1964 | D | 6344 | 7205 |
| 1958 | W | 100201 | 46283 | 29308 | 1968 | D | 7988 | 6733 |
| 1963 | W | 78676 | 36897 | 10514 | 1970 | D | 7979 | 7368 |
| 1965 | W | 36728 | 24180 | 8253 | 1985 | D | 6303 | 7197 |
| 1967 | W | 48585 | 44945 | 36663 | | | | |
| 1969 | W | 39290 | 34409 | 15475 | 30-87 | AVG | 10214 | 8719 |
| 1971 | W | 32692 | 21483 | 16533 | 53-87 | AVG | 6680 | 5934 |
| 1974 | W | 94216 | 18732 | 14241 | 30-52 | AVG | 22015 | 17456 |
| 1975 | W | 25744 | 18912 | 13658 | 53-67 | AVG | 8732 | 6973 |
| 1982 | W | 104470 | 35529 | 18953 | 68-78 | AVG | 7984 | 7051 |
| 1983 | W | 69581 | 56419 | 41173 | 79-87 | AVG | | |
| 30-87 | AVG | 61845 | 41769 | 24408 | | | | |
| 53-87 | AVG | 56542 | 33327 | 20456 | 1931 | C | 6070 | 3068 |
| 30-52 | AVG | 72452 | 58653 | 32313 | 1934 | C | 13762 | 5155 |
| 53-67 | AVG | 52085 | 35741 | 20906 | 1939 | C | 14650 | 5668 |
| 68-78 | AVG | 47986 | 23384 | 14977 | 1976 | C | 6814 | 4981 |
| 79-87 | AVG | 87026 | 45974 | 30063 | 1977 | C | 1615 | 2990 |
| | | | | | 1981 | C | 12321 | 7718 |
| | | | | | 1987 | C | 6008 | 4972 |
| 1936 | AN | 38447 | 24393 | 14512 | 30-87 | AVG | 8749 | 4936 |
| 1937 | AN | 46085 | 33492 | 12217 | 53-87 | AVG | 6690 | 5165 |
| 1940 | AN | 94517 | 25834 | 8923 | 30-52 | AVG | 11494 | 4630 |
| 1943 | AN | 46645 | 25534 | 12415 | 53-67 | AVG | | |
| 1950 | AN | 30215 | 23779 | 12852 | 68-78 | AVG | 4215 | 3986 |
| 1954 | AN | 36875 | 16927 | 8247 | 79-87 | AVG | 9165 | 6345 |
| 1978 | AN | 34486 | 16697 | 5829 | | | | |
| 30-87 | AVG | 46753 | 23808 | 10714 | | | | |
| 53-87 | AVG | 35681 | 16812 | 7038 | | | | |
| 30-52 | AVG | 51182 | 26606 | 12184 | | | | |
| 53-67 | AVG | 35681 | 16812 | 7038 | | | | |
| 68-78 | AVG | 34486 | 16697 | 5829 | | | | |
| 79-87 | AVG | 34486 | 16697 | 5829 | | | | |
| 1944 | BN | 14454 | 19045 | 6689 | | | | |
| 1945 | BN | 22542 | 21745 | 11063 | | | | |
| 1946 | BN | 27988 | 22276 | 8786 | | | | |
| 1949 | BN | 25825 | 19262 | 6574 | | | | |
| 1951 | BN | 21406 | 22176 | 7023 | | | | |
| 1955 | BN | 11231 | 17076 | 8597 | | | | |
| 1957 | BN | 12753 | 24266 | 10880 | | | | |
| 1962 | BN | 17544 | 11366 | 6115 | | | | |
| 1966 | BN | 14142 | 7387 | 3667 | | | | |
| 1972 | BN | 6915 | 6345 | 6710 | | | | |
| 1973 | BN | 13397 | 9454 | 8589 | | | | |
| 1979 | BN | 11738 | 9996 | 5509 | | | | |
| 1980 | BN | 17896 | 11775 | 10488 | | | | |
| 1984 | BN | 13515 | 9305 | 7497 | | | | |
| 1986 | BN | 22650 | 8605 | 5261 | | | | |
| 30-87 | AVG | 16933 | 14672 | 7563 | | | | |
| 53-87 | AVG | 14178 | 11558 | 7331 | | | | |
| 30-52 | AVG | 22443 | 20901 | 8027 | | | | |
| 53-67 | AVG | 13918 | 15024 | 7315 | | | | |
| 68-78 | AVG | 10156 | 7900 | 7650 | | | | |
| 79-87 | AVG | 16450 | 9920 | 7189 | | | | |

VERNALIS FLOWS, 1930-1987
(from DWR, DAYFLOW)

VERNALIS FLOW, 1930-1987
(Maximum flow = 20,000 cfs)

| YEAR | YEAR TYPE | APR Q | MAY Q | JUNE Q | AVG Q | YEAR | YEAR TYPE | APR Q | MAY Q | JUNE Q | AVG S |
|----------------|-----------|-------|-------|--------|-------|----------------|-----------|-------|-------|--------|-------|
| 1930 | D | 2581 | 2214 | 2754 | 2516 | 1930 | D | 2581 | 2214 | 2754 | 2516 |
| 1931 | C | 389 | 444 | 392 | 408 | 1931 | C | 389 | 444 | 392 | 408 |
| 1932 | AM | 4814 | 11594 | 15100 | 10503 | 1932 | AM | 4814 | 11594 | 15100 | 10503 |
| 1933 | BN | 1147 | 1384 | 5308 | 2613 | 1933 | BN | 1147 | 1384 | 5308 | 2613 |
| 1934 | C | 702 | 639 | 627 | 656 | 1934 | C | 702 | 639 | 627 | 656 |
| 1935 | AM | 14758 | 16384 | 15776 | 15639 | 1935 | AM | 14758 | 16384 | 15776 | 15639 |
| 1936 | AM | 13022 | 16784 | 11119 | 13642 | 1936 | AM | 13022 | 16784 | 11119 | 13642 |
| 1937 | W | 14463 | 20052 | 15558 | 16691 | 1937 | W | 14463 | 20000 | 15558 | 16674 |
| 1938 | W | 22410 | 28345 | 36650 | 29135 | 1938 | W | 20000 | 20000 | 20000 | 20000 |
| 1939 | C | 2467 | 2036 | 991 | 1831 | 1939 | C | 2467 | 2036 | 991 | 1831 |
| 1940 | AM | 16907 | 14300 | 10850 | 14019 | 1940 | AM | 16907 | 14300 | 10850 | 14019 |
| 1941 | W | 17087 | 21284 | 22303 | 20225 | 1941 | W | 17087 | 20000 | 20000 | 19029 |
| 1942 | W | 13414 | 16532 | 22240 | 17395 | 1942 | W | 13414 | 16532 | 20000 | 16649 |
| 1943 | AM | 18060 | 14973 | 11653 | 14895 | 1943 | AM | 18060 | 14973 | 11653 | 14895 |
| 1944 | BN | 2300 | 3827 | 3384 | 3170 | 1944 | BN | 2300 | 3827 | 3384 | 3170 |
| 1945 | AM | 8987 | 13915 | 11323 | 11408 | 1945 | AM | 8987 | 13915 | 11323 | 11408 |
| 1946 | AM | 6015 | 13058 | 5783 | 8285 | 1946 | AM | 6015 | 13058 | 5783 | 8285 |
| 1947 | D | 1488 | 2046 | 942 | 1492 | 1947 | D | 1488 | 2046 | 942 | 1492 |
| 1948 | BN | 1393 | 5001 | 8606 | 5000 | 1948 | BN | 1393 | 5001 | 8606 | 5000 |
| 1949 | BN | 2058 | 3530 | 2003 | 2530 | 1949 | BN | 2058 | 3530 | 2003 | 2530 |
| 1950 | BN | 5367 | 5012 | 5014 | 5131 | 1950 | BN | 5367 | 5012 | 5014 | 5131 |
| 1951 | BN | 2652 | 6525 | 3338 | 4172 | 1951 | BN | 2652 | 6525 | 3338 | 4172 |
| 1952 | W | 20197 | 27639 | 23340 | 23725 | 1952 | W | 20000 | 20000 | 20000 | 20000 |
| 1953 | BN | 1520 | 3059 | 4914 | 3164 | 1953 | BN | 1520 | 3059 | 4914 | 3164 |
| 1954 | BN | 5059 | 6716 | 1286 | 4354 | 1954 | BN | 5059 | 6716 | 1286 | 4354 |
| 1955 | BN | 917 | 1150 | 1496 | 1188 | 1955 | BN | 917 | 1150 | 1496 | 1188 |
| 1956 | W | 6261 | 13911 | 12251 | 10808 | 1956 | W | 6261 | 13911 | 12251 | 10808 |
| 1957 | BN | 1326 | 2582 | 3759 | 2556 | 1957 | BN | 1326 | 2582 | 3759 | 2556 |
| 1958 | W | 27920 | 22419 | 15617 | 21985 | 1958 | W | 20000 | 20000 | 15617 | 18539 |
| 1959 | C | 812 | 791 | 533 | 712 | 1959 | C | 812 | 791 | 533 | 712 |
| 1960 | C | 517 | 618 | 293 | 476 | 1960 | C | 517 | 618 | 293 | 476 |
| 1961 | C | 200 | 380 | 207 | 262 | 1961 | C | 200 | 380 | 207 | 262 |
| 1962 | AM | 2085 | 2621 | 3497 | 2734 | 1962 | AM | 2085 | 2621 | 3497 | 2734 |
| 1963 | AM | 8616 | 9339 | 6663 | 8206 | 1963 | AM | 8616 | 9339 | 6663 | 8206 |
| 1964 | D | 764 | 703 | 650 | 706 | 1964 | D | 764 | 703 | 650 | 706 |
| 1965 | W | 9859 | 5296 | 5650 | 6935 | 1965 | W | 9859 | 5296 | 5650 | 6935 |
| 1966 | D | 982 | 863 | 570 | 805 | 1966 | D | 982 | 863 | 570 | 805 |
| 1967 | W | 14495 | 20365 | 20000 | 18287 | 1967 | W | 14495 | 20000 | 20000 | 18165 |
| 1968 | C | 1435 | 891 | 592 | 973 | 1968 | C | 1435 | 891 | 592 | 973 |
| 1969 | W | 22117 | 24613 | 27887 | 24872 | 1969 | W | 20000 | 20000 | 20000 | 20000 |
| 1970 | BN | 1673 | 2393 | 2737 | 2268 | 1970 | BN | 1673 | 2393 | 2737 | 2268 |
| 1971 | BN | 1961 | 1833 | 2322 | 2039 | 1971 | BN | 1961 | 1833 | 2322 | 2039 |
| 1972 | D | 1037 | 744 | 587 | 789 | 1972 | D | 1037 | 744 | 587 | 789 |
| 1973 | AM | 4203 | 2937 | 2576 | 3239 | 1973 | AM | 4203 | 2937 | 2576 | 3239 |
| 1974 | W | 5850 | 4106 | 3860 | 4605 | 1974 | W | 5850 | 4106 | 3860 | 4605 |
| 1975 | W | 3957 | 3972 | 5708 | 4546 | 1975 | W | 3957 | 3972 | 5708 | 4546 |
| 1976 | C | 1293 | 939 | 798 | 1010 | 1976 | C | 1293 | 939 | 798 | 1010 |
| 1977 | C | 212 | 400 | 118 | 243 | 1977 | C | 212 | 400 | 118 | 243 |
| 1978 | W | 20030 | 19119 | 7069 | 15406 | 1978 | W | 20000 | 19119 | 7069 | 15396 |
| 1979 | AM | 3506 | 2524 | 2254 | 2761 | 1979 | AM | 3506 | 2524 | 2254 | 2761 |
| 1980 | W | 10249 | 9912 | 5305 | 8489 | 1980 | W | 10249 | 9912 | 5305 | 8489 |
| 1981 | D | 2532 | 1967 | 1499 | 1999 | 1981 | D | 2532 | 1967 | 1499 | 1999 |
| 1982 | W | 22963 | 18654 | 7584 | 16400 | 1982 | W | 20000 | 18654 | 7584 | 15413 |
| 1983 | W | 36447 | 31771 | 26083 | 31434 | 1983 | W | 20000 | 20000 | 20000 | 20000 |
| 1984 | BN | 4285 | 3240 | 2297 | 3274 | 1984 | BN | 4285 | 3240 | 2297 | 3274 |
| 1985 | D | 2445 | 2134 | 1751 | 2110 | 1985 | D | 2445 | 2134 | 1751 | 2110 |
| 1986 | W | 19590 | 8764 | 6233 | 11529 | 1986 | W | 19590 | 8764 | 6233 | 11529 |
| 1987 | C | 2867 | 2178 | 1990 | 2345 | 1987 | C | 2867 | 2178 | 1990 | 2345 |
| 30-87 AVG | | 7632 | 8300 | 7271 | 7734 | 30-87 AVG | | 7079 | 7671 | 6607 | 7119 |
| 30-52 AVG | | 8377 | 10762 | 10220 | 9786 | 30-52 AVG | | 8264 | 10009 | 9153 | 9142 |
| 53-87 AVG | | 7142 | 6683 | 5332 | 6386 | 53-87 AVG | | 6300 | 6135 | 4933 | 5790 |
| 72-87 AVG | | 8842 | 7085 | 4732 | 6886 | 72-87 AVG | | 7627 | 6349 | 4352 | 6109 |
| 72-87 AVG(-83) | | 7001 | 5439 | 3309 | 5250 | 72-87 AVG(-83) | | 6802 | 5439 | 3309 | 5183 |

VERNALIS FLOWS, 1930-1987
(DWR, DAYFLOW by Year Type)

VERNALIS FLOW, 1930-1987
(Maximum flow = 20,000 cfs)

| YEAR | YEAR TYPE | APR Q | MAY Q | JUNE Q | AVG Q |
|-----------|-----------|-------|-------|--------|-------|
| 1937 | W | 14463 | 20052 | 15558 | 16691 |
| 1938 | W | 22410 | 28345 | 36650 | 29135 |
| 1941 | W | 17087 | 21284 | 22303 | 20225 |
| 1942 | W | 13414 | 16532 | 22240 | 17395 |
| 1952 | W | 20197 | 27639 | 23340 | 23725 |
| 1956 | W | 6261 | 13911 | 12251 | 10808 |
| 1958 | W | 27920 | 22419 | 15617 | 21985 |
| 1965 | W | 9859 | 5296 | 5650 | 6935 |
| 1967 | W | 14495 | 20365 | 20000 | 18287 |
| 1969 | W | 22117 | 24613 | 27887 | 24872 |
| 1974 | W | 5850 | 4106 | 3860 | 4605 |
| 1975 | W | 3957 | 3972 | 5708 | 4546 |
| 1978 | W | 20030 | 19119 | 7069 | 15406 |
| 1980 | W | 10249 | 9912 | 5305 | 8489 |
| 1982 | W | 22963 | 18654 | 7584 | 16400 |
| 1983 | W | 36447 | 31771 | 26083 | 31434 |
| 1986 | W | 19590 | 8764 | 6233 | 11529 |
| ----- | | | | | |
| 30-87 AVG | | 16901 | 17456 | 15490 | 16616 |
| 53-87 AVG | | 16645 | 15242 | 11937 | 14608 |
| 30-52 AVG | | 17514 | 22770 | 24018 | 21434 |
| ----- | | | | | |
| 1932 | AN | 4814 | 11594 | 15100 | 10503 |
| 1935 | AN | 14758 | 16384 | 15776 | 15639 |
| 1936 | AN | 13022 | 16784 | 11119 | 13642 |
| 1940 | AN | 16907 | 14300 | 10850 | 14019 |
| 1943 | AN | 18060 | 14973 | 11653 | 14895 |
| 1945 | AN | 8987 | 13915 | 11323 | 11408 |
| 1946 | AN | 6015 | 13058 | 5783 | 8285 |
| 1962 | AN | 2085 | 2621 | 3497 | 2734 |
| 1963 | AN | 8616 | 9339 | 6663 | 8206 |
| 1973 | AN | 4203 | 2937 | 2576 | 3239 |
| 1979 | AN | 3506 | 2524 | 2254 | 2761 |
| ----- | | | | | |
| 30-87 AVG | | 9179 | 10766 | 8781 | 9576 |
| 53-87 AVG | | 4603 | 4355 | 3748 | 4235 |
| 30-52 AVG | | 11795 | 14430 | 11658 | 12627 |
| ----- | | | | | |
| 1933 | BN | 1147 | 1384 | 5308 | 2613 |
| 1944 | BN | 2300 | 3827 | 3384 | 3170 |
| 1948 | BN | 1393 | 5001 | 8606 | 5000 |
| 1949 | BN | 2058 | 3530 | 2003 | 2530 |
| 1950 | BN | 5367 | 5012 | 5014 | 5131 |
| 1951 | BN | 2652 | 6525 | 3338 | 4172 |
| 1953 | BN | 1520 | 3059 | 4914 | 3164 |
| 1954 | BN | 5059 | 6716 | 1286 | 4354 |
| 1955 | BN | 917 | 1150 | 1496 | 1188 |
| 1957 | BN | 1326 | 2582 | 3759 | 2556 |
| 1970 | BN | 1673 | 2393 | 2737 | 2268 |
| 1971 | BN | 1961 | 1833 | 2322 | 2039 |
| 1984 | BN | 4285 | 3240 | 2297 | 3274 |
| ----- | | | | | |
| 30-87 AVG | | 2435 | 3558 | 3574 | 3189 |
| 53-87 AVG | | 2392 | 2996 | 2687 | 2692 |
| 30-52 AVG | | 2486 | 4213 | 4609 | 3769 |
| ----- | | | | | |
| 1930 | D | 2581 | 2214 | 2754 | 2516 |
| 1947 | D | 1488 | 2046 | 942 | 1492 |
| 1964 | D | 764 | 703 | 650 | 706 |
| 1966 | D | 982 | 863 | 570 | 805 |
| 1972 | D | 1037 | 744 | 587 | 789 |
| 1981 | D | 2532 | 1967 | 1499 | 1999 |
| 1985 | D | 2445 | 2134 | 1751 | 2110 |
| ----- | | | | | |
| 30-87 AVG | | 1690 | 1524 | 1250 | 1488 |
| 53-87 AVG | | 1552 | 1282 | 1011 | 1282 |
| 30-52 AVG | | 2035 | 2130 | 1848 | 2004 |
| ----- | | | | | |
| 1931 | C | 389 | 444 | 392 | 408 |
| 1934 | C | 702 | 639 | 627 | 656 |
| 1939 | C | 2467 | 2036 | 991 | 1831 |
| 1959 | C | 812 | 791 | 533 | 712 |
| 1960 | C | 517 | 618 | 293 | 476 |
| 1961 | C | 200 | 380 | 207 | 262 |
| 1968 | C | 1435 | 891 | 592 | 973 |
| 1976 | C | 1293 | 939 | 798 | 1010 |
| 1977 | C | 212 | 400 | 118 | 243 |
| 1987 | C | 2867 | 2178 | 1990 | 2345 |
| ----- | | | | | |
| 30-87 AVG | | 1089 | 932 | 654 | 892 |
| 53-87 AVG | | 1048 | 885 | 647 | 860 |
| 30-52 AVG | | 1186 | 1040 | 670 | 965 |

| YEAR | YEAR TYPE | APR Q | MAY Q | JUNE Q | AVG Q |
|-----------|-----------|-------|-------|--------|-------|
| 1937 | W | 14463 | 20000 | 15558 | 16674 |
| 1938 | W | 20000 | 20000 | 20000 | 20000 |
| 1941 | W | 17087 | 20000 | 20000 | 19029 |
| 1942 | W | 13414 | 16532 | 20000 | 16649 |
| 1952 | W | 20000 | 20000 | 20000 | 20000 |
| 1956 | W | 6261 | 13911 | 12251 | 10808 |
| 1958 | W | 20000 | 20000 | 15617 | 18539 |
| 1965 | W | 9859 | 5296 | 5650 | 6935 |
| 1967 | W | 14495 | 20000 | 20000 | 18165 |
| 1969 | W | 20000 | 20000 | 20000 | 20000 |
| 1974 | W | 5850 | 4106 | 3860 | 4605 |
| 1975 | W | 3957 | 3972 | 5708 | 4546 |
| 1978 | W | 20000 | 19119 | 7069 | 15396 |
| 1980 | W | 10249 | 9912 | 5305 | 8489 |
| 1982 | W | 20000 | 18654 | 7584 | 15413 |
| 1983 | W | 20000 | 20000 | 20000 | 20000 |
| 1986 | W | 19590 | 8764 | 6233 | 11529 |
| ----- | | | | | |
| 30-87 AVG | | 15013 | 15310 | 13226 | 14516 |
| 53-87 AVG | | 14188 | 13645 | 10773 | 12869 |
| 30-52 AVG | | 16993 | 19306 | 19112 | 18470 |
| ----- | | | | | |
| 1932 | AN | 4814 | 11594 | 15100 | 10503 |
| 1935 | AN | 14758 | 16384 | 15776 | 15639 |
| 1936 | AN | 13022 | 16784 | 11119 | 13642 |
| 1940 | AN | 16907 | 14300 | 10850 | 14019 |
| 1943 | AN | 18060 | 14973 | 11653 | 14895 |
| 1945 | AN | 8987 | 13915 | 11323 | 11408 |
| 1946 | AN | 6015 | 13058 | 5783 | 8285 |
| 1962 | AN | 2085 | 2621 | 3497 | 2734 |
| 1963 | AN | 8616 | 9339 | 6663 | 8206 |
| 1973 | AN | 4203 | 2937 | 2576 | 3239 |
| 1979 | AN | 3506 | 2524 | 2254 | 2761 |
| ----- | | | | | |
| 30-87 AVG | | 9179 | 10766 | 8781 | 9576 |
| 53-87 AVG | | 4603 | 4355 | 3748 | 4235 |
| 30-52 AVG | | 11795 | 14430 | 11658 | 12627 |
| ----- | | | | | |
| 1933 | BN | 1147 | 1384 | 5308 | 2613 |
| 1944 | BN | 2300 | 3827 | 3384 | 3170 |
| 1948 | BN | 1393 | 5001 | 8606 | 5000 |
| 1949 | BN | 2058 | 3530 | 2003 | 2530 |
| 1950 | BN | 5367 | 5012 | 5014 | 5131 |
| 1951 | BN | 2652 | 6525 | 3338 | 4172 |
| 1953 | BN | 1520 | 3059 | 4914 | 3164 |
| 1954 | BN | 5059 | 6716 | 1286 | 4354 |
| 1955 | BN | 917 | 1150 | 1496 | 1188 |
| 1957 | BN | 1326 | 2582 | 3759 | 2556 |
| 1970 | BN | 1673 | 2393 | 2737 | 2268 |
| 1971 | BN | 1961 | 1833 | 2322 | 2039 |
| 1984 | BN | 4285 | 3240 | 2297 | 3274 |
| ----- | | | | | |
| 30-87 AVG | | 2435 | 3558 | 3574 | 3189 |
| 53-87 AVG | | 2392 | 2996 | 2687 | 2692 |
| 30-52 AVG | | 2486 | 4213 | 4609 | 3769 |
| ----- | | | | | |
| 1930 | D | 2581 | 2214 | 2754 | 2516 |
| 1947 | D | 1488 | 2046 | 942 | 1492 |
| 1964 | D | 764 | 703 | 650 | 706 |
| 1966 | D | 982 | 863 | 570 | 805 |
| 1972 | D | 1037 | 744 | 587 | 789 |
| 1981 | D | 2532 | 1967 | 1499 | 1999 |
| 1985 | D | 2445 | 2134 | 1751 | 2110 |
| ----- | | | | | |
| 30-87 AVG | | 1690 | 1524 | 1250 | 1488 |
| 53-87 AVG | | 1552 | 1282 | 1011 | 1282 |
| 30-52 AVG | | 2035 | 2130 | 1848 | 2004 |
| ----- | | | | | |
| 1931 | C | 389 | 444 | 392 | 408 |
| 1934 | C | 702 | 639 | 627 | 656 |
| 1939 | C | 2467 | 2036 | 991 | 1831 |
| 1959 | C | 812 | 791 | 533 | 712 |
| 1960 | C | 517 | 618 | 293 | 476 |
| 1961 | C | 200 | 380 | 207 | 262 |
| 1968 | C | 1435 | 891 | 592 | 973 |
| 1976 | C | 1293 | 939 | 798 | 1010 |
| 1977 | C | 212 | 400 | 118 | 243 |
| 1987 | C | 2867 | 2178 | 1990 | 2345 |
| ----- | | | | | |
| 30-87 AVG | | 1089 | 932 | 654 | 892 |
| 53-87 AVG | | 1048 | 885 | 647 | 860 |
| 30-52 AVG | | 1186 | 1040 | 670 | 965 |

TOTAL EXPORTS FROM THE DELTA, 1951 - 1987
 AVERAGE DAILY FLOWS, CFS; YEARLY TOTALS, ACRE-FEET; FROM DAYFLOW

| WATER YEAR | CVP | SWP /1/ | CONTRA COSTA CANAL | TOTAL EXPORTS CFS /1/ | TOTAL EXPORTS AC-FT | TOTAL CVP+SWP AC-FT |
|------------|-------|---------|--------------------|-----------------------|---------------------|---------------------|
| 1950 | 0 | 0 | 30 | 30 | 21,719 | 0 |
| 1951 | 224 | 0 | 41 | 265 | 191,851 | 162,169 |
| 1952 | 228 | 0 | 41 | 269 | 195,281 | 1,657,428 |
| 1953 | 1,076 | 0 | 48 | 1,124 | 813,739 | 778,988 |
| 1954 | 1,386 | 0 | 58 | 1,444 | 1,045,408 | 1,003,418 |
| 1955 | 1,555 | 0 | 66 | 1,621 | 1,173,550 | 1,125,769 |
| 1956 | 994 | 0 | 61 | 1,055 | 765,878 | 721,595 |
| 1957 | 1,629 | 0 | 74 | 1,703 | 1,232,916 | 1,179,342 |
| 1958 | 907 | 0 | 66 | 973 | 704,420 | 656,638 |
| 1959 | 1,844 | 0 | 95 | 1,939 | 1,403,772 | 1,334,995 |
| 1960 | 1,910 | 0 | 105 | 2,015 | 1,462,790 | 1,386,565 |
| 1961 | 2,048 | 0 | 108 | 2,156 | 1,560,873 | 1,482,684 |
| 1962 | 1,864 | 0 | 99 | 1,963 | 1,421,147 | 1,349,474 |
| 1963 | 1,847 | 0 | 86 | 1,933 | 1,399,428 | 1,337,167 |
| 1964 | 2,266 | 0 | 113 | 2,379 | 1,727,036 | 1,645,004 |
| 1965 | 2,026 | 0 | 100 | 2,126 | 1,539,154 | 1,466,757 |
| 1966 | 2,200 | 0 | 116 | 2,316 | 1,676,707 | 1,592,727 |
| 1967 | 1,729 | 0 | 99 | 1,828 | 1,323,412 | 1,251,739 |
| 1968 | 2,749 | 653 | 133 | 3,535 | 2,566,235 | 2,469,683 |
| 1969 | 2,546 | 1,424 | 107 | 4,077 /2/ | 2,951,613 | 2,874,149 |
| 1970 | 2,281 | 574 | 130 | 2,985 | 2,161,041 | 2,066,926 |
| 1971 | 2,647 | 1,261 | 104 | 4,012 | 2,904,555 | 2,829,263 |
| 1972 | 3,232 | 1,508 | 143 | 4,883 /3/ | 3,544,816 | 3,441,005 |
| 1973 | 2,549 | 2,096 | 128 | 4,773 /3/ | 3,455,494 | 3,362,826 |
| 1974 | 3,376 | 2,645 | 109 | 6,130 | 4,437,917 | 4,359,005 |
| 1975 | 3,249 | 2,143 | 109 | 5,501 | 3,982,542 | 3,903,630 |
| 1976 | 4,146 | 2,513 | 153 | 6,812 | 4,945,174 | 4,834,104 |
| 1977 | 1,769 | 1,101 | 137 | 3,016 /4/ | 2,183,484 | 2,077,785 |
| 1978 | 3,134 | 2,872 | 106 | 6,138 /4/ | 4,443,709 | 4,348,145 |
| 1979 | 3,158 | 3,013 | 126 | 6,297 | 4,558,820 | 4,467,600 |
| 1980 | 2,764 | 3,463 | 120 | 6,347 | 4,607,607 | 4,520,493 |
| 1981 | 3,602 | 2,908 | 145 | 6,655 | 4,818,000 | 4,713,025 |
| 1982 | 2,729 | 3,651 | 104 | 6,484 | 4,694,201 | 4,618,909 |
| 1983 | 3,459 | 2,616 | 110 | 6,185 | 4,477,735 | 4,398,099 |
| 1984 | 3,018 | 2,268 | 135 | 5,421 | 3,935,377 | 3,837,374 |
| 1985 | 3,854 | 3,700 | 156 | 7,710 | 5,581,785 | 5,468,846 |
| 1986 | 3,616 | 3,683 | 152 | 7,451 /5/ | 5,394,277 | 5,284,235 |
| 1987 | 3,811 | 3,152 | 180 | 7,143 | 5,171,296 | 5,040,982 |

NOTES

- /1/ Does NOT include diversions from Byron-Bethany Irrigation District; DAYFLOW includes BBID in channel depletions.
- /2/ Total export value different from DAYFLOW; effects of Sherman Island flooding and dewatering (MISC) NOT included.
- /3/ Total export value different from DAYFLOW; effects of Andrus and Brannon islands flooding and dewatering (MISC) NOT included.
- /4/ Total export value INCLUDES export (MISC) to Mokelumne Aqueduct from Middle River (9/1/77 - 1/14/88), averaged over water years (1977 = 9 CFS; 1978 = 26 CFS).
- /5/ Total export value different from DAYFLOW; effects of Delta island flooding and dewatering (MISC) NOT included.

| AVERAGE EXPORTS (ACRE-FEET) | TOTAL | CVP+SWP |
|-----------------------------|-----------|-----------|
| YEARS | | |
| 1950-1987 | 2,644,073 | 2,606,541 |
| 1953-1967 | 1,283,349 | 1,220,857 |
| 1953-1987 | 2,859,026 | 2,777,970 |
| 1968-1987 | 4,040,784 | 3,945,804 |
| 1979-1987 | 4,804,344 | 4,705,507 |

TOTAL DELTA EXPORTS (CVP, SWP, AND CCC) - CFS
1953-1987 FROM DAYFLOW

| WATER YR. | YR. | TYPE | APRIL | MAY | JUNE | JULY | AVG |
|-----------|-----|------|-------|-------|-------|--------|-------|
| 1953 | BN | | 1,421 | 2,109 | 2,311 | 2,905 | 2,187 |
| 1954 | BN | | 2,052 | 1,371 | 3,001 | 3,293 | 2,429 |
| 1955 | BN | | 2,283 | 2,447 | 3,194 | 3,206 | 2,783 |
| 1956 | W | | 704 | 423 | 1,179 | 3,248 | 1,389 |
| 1957 | BN | | 2,353 | 2,186 | 3,277 | 3,591 | 2,852 |
| 1958 | W | | 152 | 599 | 772 | 2,931 | 1,114 |
| 1959 | C | | 2,757 | 2,661 | 3,564 | 4,005 | 3,247 |
| 1960 | C | | 2,605 | 2,688 | 3,825 | 4,095 | 3,303 |
| 1961 | C | | 2,900 | 2,837 | 3,992 | 4,656 | 3,596 |
| 1962 | AN | | 2,761 | 2,963 | 3,799 | 4,229 | 3,438 |
| 1963 | AN | | 1,231 | 2,774 | 3,543 | 4,198 | 2,937 |
| 1964 | D | | 3,065 | 3,261 | 3,795 | 4,619 | 3,685 |
| 1965 | W | | 1,204 | 3,193 | 3,694 | 4,361 | 3,113 |
| 1966 | D | | 3,108 | 3,381 | 4,075 | 4,597 | 3,790 |
| 1967 | W | | 1,207 | 1,921 | 2,162 | 2,697 | 1,997 |
| 1968 | C | | 5,380 | 5,611 | 4,708 | 5,168 | 5,217 |
| *1969 | W | | 3,212 | 3,270 | 2,494 | 3,382 | 3,090 |
| 1970 | BN | | 4,653 | 4,012 | 4,997 | 5,227 | 4,722 |
| 1971 | BN | | 4,431 | 4,549 | 5,768 | 6,509 | 5,314 |
| *1972 | D | | 6,356 | 6,495 | 5,350 | 5,074 | 5,819 |
| 1973 | AN | | 3,352 | 6,501 | 7,355 | 7,693 | 6,225 |
| 1974 | W | | 4,203 | 7,130 | 9,130 | 10,691 | 7,789 |
| 1975 | W | | 6,304 | 5,583 | 4,520 | 5,184 | 5,398 |
| 1976 | C | | 5,037 | 5,488 | 4,152 | 4,109 | 4,697 |
| 1977 | C | | 1,295 | 2,987 | 739 | 845 | 1,467 |
| 1978 | W | | 3,271 | 3,058 | 7,621 | 8,088 | 5,510 |
| 1979 | AN | | 5,882 | 6,245 | 6,341 | 9,339 | 6,952 |
| 1980 | W | | 5,343 | 4,630 | 5,961 | 6,869 | 5,701 |
| 1981 | D | | 8,090 | 4,478 | 4,032 | 7,046 | 5,912 |
| 1982 | W | | 9,603 | 5,994 | 3,935 | 4,032 | 5,891 |
| 1983 | W | | 3,814 | 3,293 | 5,010 | 5,207 | 4,331 |
| 1984 | BN | | 7,685 | 5,929 | 6,165 | 9,457 | 7,309 |
| 1985 | D | | 7,342 | 6,215 | 6,530 | 9,465 | 7,388 |
| *1986 | W | | 4,696 | 6,260 | 6,177 | 8,607 | 6,435 |
| 1987 | C | | 7,021 | 5,313 | 5,183 | 8,952 | 6,617 |

*VALUES DIFFERENT FROM DAYFLOW; DO NOT INCLUDE EFFECTS OF
DELTA FLOODING AND DEWATERING

TOTAL DELTA EXPORTS (CVP, SWP, AND CCC) - CFS
YEAR TYPE SUMMARY FROM DAYFLOW

1953-1967

| WATER YR. | YR. TYPE | APRIL | MAY | JUNE | JULY | AVG |
|-----------|----------|-------|-------|-------|-------|-------|
| AVERAGE | W(4) | 817 | 1,534 | 1,952 | 3,309 | 1,903 |
| AVERAGE | AN(2) | 1,996 | 2,869 | 3,671 | 4,214 | 3,187 |
| AVERAGE | BN(4) | 2,027 | 2,028 | 2,946 | 3,249 | 2,563 |
| AVERAGE | D(2) | 3,087 | 3,321 | 3,935 | 4,608 | 3,738 |
| AVERAGE | C(3) | 2,754 | 2,729 | 3,794 | 4,252 | 3,382 |
| GRND MEAN | 15 | 2,136 | 2,496 | 3,259 | 3,926 | 2,954 |
| WTDGNDMN | 15 | 1,987 | 2,321 | 3,079 | 3,775 | 2,791 |

1968-1987*

| WATER YR. | YR. TYPE | APRIL | MAY | JUNE | JULY | AVG |
|-----------|----------|-------|-------|-------|-------|-------|
| AVERAGE | W(8) | 5,056 | 4,902 | 5,606 | 6,508 | 5,518 |
| AVERAGE | AN(2) | 4,617 | 6,373 | 6,848 | 8,516 | 6,589 |
| AVERAGE | BN(3) | 5,590 | 4,830 | 5,643 | 7,064 | 5,782 |
| AVERAGE | D(3) | 7,263 | 5,729 | 5,304 | 7,195 | 6,373 |
| AVERAGE | C(4) | 4,683 | 4,850 | 3,696 | 4,769 | 4,499 |
| GRND MEAN | 20 | 5,442 | 5,337 | 5,419 | 6,810 | 5,752 |
| WTDGNDMN | 20 | 5,349 | 5,152 | 5,308 | 6,547 | 5,589 |

1979-1987*

| WATER YR. | YR. TYPE | APR | MAY | JUN | JUL | AVG |
|-----------|----------|-------|-------|-------|-------|-------|
| AVERAGE | W(4) | 5864 | 5044 | 5271 | 6179 | 5,589 |
| 1979 | AN(1) | 5882 | 6245 | 6341 | 9339 | 6,952 |
| 1984 | BN(1) | 7685 | 5929 | 6165 | 9457 | 7,309 |
| AVERAGE | D(2) | 7716 | 5347 | 5281 | 8256 | 6,650 |
| 1987 | C(1) | 7021 | 5313 | 5183 | 8952 | 6,617 |
| GRND MEAN | 9 | 6,834 | 5,576 | 5,648 | 8,436 | 6,623 |
| WTDGNDMN | 9 | 6,608 | 5,373 | 5,482 | 7,664 | 6,282 |

1953-1987*

| WATER YR. | YR. TYPE | APRIL | MAY | JUNE | JULY | AVG |
|-----------|----------|-------|-------|-------|-------|-------|
| AVERAGE | W(12) | 3,643 | 3,780 | 4,388 | 5,441 | 4,313 |
| AVERAGE | AN(4) | 3,307 | 4,621 | 5,260 | 6,365 | 4,888 |
| AVERAGE | BN(7) | 3,554 | 3,229 | 4,102 | 4,884 | 3,942 |
| AVERAGE | D(5) | 5,592 | 4,766 | 4,756 | 6,160 | 5,319 |
| AVERAGE | C(7) | 3,856 | 3,941 | 3,738 | 4,547 | 4,020 |
| GRND MEAN | 35 | 3,990 | 4,067 | 4,449 | 5,480 | 4,496 |
| WTDGNDMN | 35 | 3,908 | 3,939 | 4,353 | 5,359 | 4,390 |

GRND MEAN = AVERAGE OF ALL YEARS IN GROUP
WTDGNDMN = AVERAGE OF ALL YEARS IN GROUP WEIGHTED BY FREQUENCY OF EACH YEAR TYPE IN GROUP

* = VALUES DIFFERENT FROM DAYFLOW; DO NOT INCLUDE EFFECTS OF DELTA FLOODING AND DEWATERING IN 1969, 1972 AND 1986

CHIPPS ISLAND OUTFLOWS - CFS
1953-1987

FROM DAYFLOW

 WATER YR.YR. TYPE APRIL MAY JUNE JULY AVG
 =====
 1953 W 31,143 37,831 33,076 6,109 27,040
 1954 AN 58,670 30,223 6,865 1,314 24,268
 1955 BN 13,343 19,156 6,999 2,280 10,445
 1956 W 40,217 59,667 35,498 8,795 36,044
 1957 BN 20,480 32,732 15,581 2,427 17,805
 1958 W 153,782 78,859 50,529 12,009 73,795
 1959 D 11,607 7,303 1,322 2,561 5,698
 1960 D 16,878 12,407 3,847 2,244 8,844
 1961 D 13,397 8,580 3,541 1,672 6,798
 1962 BN 27,385 18,173 10,317 2,795 14,668
 1963 W 102,776 53,124 19,180 5,639 45,180
 1964 D 9,187 9,784 5,302 3,185 6,865
 1965 W 56,912 32,370 16,990 5,865 28,034
 1966 BN 18,946 9,835 2,460 3,155 8,599
 1967 W 77,685 74,550 61,265 23,864 59,341
 1968 D 9,932 6,737 3,666 3,684 6,005
 1969 W 69,375 64,564 46,596 13,143 48,420
 1970 D 11,027 10,761 6,214 5,256 8,315
 1971 W 36,983 26,406 21,218 11,654 24,065
 1972 BN 7,542 5,140 2,891 6,211 5,446
 1973 BN 22,191 11,699 7,211 4,599 11,425
 1974 W 109,547 25,544 16,943 9,365 40,350
 1975 W 34,519 28,796 22,508 11,129 24,238
 1976 C 8,833 4,066 3,915 4,343 5,289
 1977 C 3,083 3,999 2,521 3,212 3,204
 1978 AN 61,276 40,874 9,086 3,974 28,803
 1979 BN 14,485 13,435 5,326 5,384 9,658
 1980 BN 28,689 20,912 14,870 11,191 18,916
 1981 C 11,653 9,143 4,596 5,296 7,672
 1982 W 142,203 57,876 28,515 16,849 61,361
 1983 W 118,109 98,707 71,038 43,860 82,929
 1984 BN 14,732 11,204 8,038 10,252 11,057
 1985 D 6,913 7,378 5,215 4,934 6,110
 1986 BN 46,572 15,911 9,322 7,384 19,797
 1987 C 6,291 4,951 3,496 3,829 4,642

CHIPPS ISLAND OUTFLOWS - CFS
 YEAR TYPE SUMMARY FROM DAYFLOW
 1953-1967

| WATER YR.YR. TYPE | APRIL | MAY | JUNE | JULY | AVG |
|-------------------|--------|--------|--------|--------|--------|
| AVERAGE W(6) | 77,086 | 56,067 | 36,090 | 10,380 | 44,906 |
| 1954 AN(1) | 58,670 | 30,223 | 6,865 | 1,314 | 24,268 |
| AVERAGE BN(4) | 20,039 | 19,974 | 8,839 | 2,664 | 12,879 |
| AVERAGE D(4) | 12,767 | 9,519 | 3,503 | 2,416 | 7,051 |
| - C(0) | - | - | - | - | - |
| GRND MEAN 15 | 42,140 | 28,946 | 13,824 | 4,193 | 22,276 |
| WTDGNDMN 15 | 43,494 | 32,306 | 18,185 | 5,594 | 24,895 |

1968-1987

| WATER YR.YR. TYPE | APRIL | MAY | JUNE | JULY | AVG. |
|-------------------|--------|--------|--------|--------|--------|
| AVERAGE W(6) | 85,123 | 50,316 | 34,470 | 17,667 | 46,894 |
| 1978 AN(1) | 61,276 | 40,874 | 9,086 | 3,974 | 28,803 |
| AVERAGE BN(6) | 22,369 | 13,050 | 7,943 | 7,504 | 12,716 |
| AVERAGE D(3) | 9,291 | 8,292 | 5,032 | 4,625 | 6,810 |
| AVERAGE C(4) | 7,465 | 5,540 | 3,632 | 4,170 | 5,202 |
| GRND MEAN 20 | 37,105 | 23,614 | 12,032 | 7,588 | 20,085 |
| WTDGNDMN 20 | 38,198 | 23,405 | 14,659 | 9,277 | 21,385 |

1979-1987

| WATER YR.YR. TYPE | APR | MAY | JUN | JUL | AVE |
|-------------------|---------|--------|--------|--------|--------|
| AVERAGE W(2) | 129,108 | 77,936 | 50,335 | 30,365 | 71,936 |
| - AN(0) | - | - | - | - | - |
| AVERAGE BN(4) | 26,120 | 15,366 | 9,389 | 8,553 | 14,857 |
| 1985 D(1) | 6,913 | 7,378 | 5,215 | 4,934 | 6,110 |
| AVERAGE C(2) | 9,131 | 6,994 | 3,981 | 4,201 | 6,077 |
| GRND MEAN 9 | 42,818 | 26,918 | 17,230 | 12,013 | 24,745 |
| WTDGNDMN 9 | 43,097 | 26,522 | 16,822 | 12,031 | 24,618 |

1953-1987

| WATER YR.YR. TYPE | APRIL | MAY | JUNE | JULY | AVG. |
|-------------------|--------|--------|--------|--------|--------|
| AVERAGE W(12) | 81,104 | 53,191 | 35,280 | 14,023 | 45,900 |
| AVERAGE AN(2) | 59,973 | 35,549 | 7,976 | 2,644 | 26,535 |
| AVERAGE BN(10) | 21,437 | 15,820 | 8,302 | 5,568 | 12,781 |
| AVERAGE D(7) | 11,277 | 8,993 | 4,158 | 3,362 | 6,948 |
| AVERAGE C(4) | 7,465 | 5,540 | 3,632 | 4,170 | 5,202 |
| GRND MEAN 35 | 36,251 | 23,818 | 11,869 | 5,954 | 19,473 |
| WTDGNDMN 35 | 40,468 | 27,220 | 16,170 | 7,699 | 22,889 |

 GRND MEAN = AVERAGE OF ALL YEARS IN GROUP
 WTDGNDMN = AVERAGE OF ALL YEARS IN GROUP WEIGHTED BY FREQUENCY OF EACH YEAR TYPE IN GROUP

APPENDIX C

Terms, Symbols and Abbreviations

- C-1 Glossary
- C-2 Abbreviations for Information Sources
and Citations
- C-3 Monitoring Stations
- C-4 Lists of Symbols and Abbreviations

BAY-DELTA HEARING
WATER QUALITY CONTROL PLAN

GLOSSARY

| WORD/PHRASE | DEFINITION |
|--------------------------------|---|
| 1-in-20 dry year | A statistical term referring to a water year with a total annual runoff exceeded by 95% of the water years which are likely to occur. |
| Acre-Foot (AF) | The quantity of water which will cover an acre of land to a depth of one foot (i.e. 43,560 cubic feet or 325,900 gallons). |
| Algae | Simple rootless plants that grow in bodies of water at rates in relative proportion to the amounts of nutrients available in the water or, in the case of nitrogen, in the atmosphere overlying the water body. |
| Anadromous | Pertaining to fish that spend part of their life cycle in the ocean and return to freshwater streams to spawn (SWRCB Order no. WQ 85-1). |
| Arsenic (As) | A highly poisonous metallic element. Arsenic and its compounds are used in insecticides, weed killers and industrial processes (SWRCB Order no. W.Q. 85-1). |
| Banks, Harvey O. Pumping Plant | The Department of Water Resources' State Water Project main delpumping plant located West of Tracy. The source of the water in the California Aquaduct. |
| Basin plan | A plan for the protection of water quality prepared by a Regional Water Quality Control Board in response to the federal Clean Water Act (SWRCB Order no. W.Q. 85-1). |
| Bathymetry | Measurements of the differences in depth between mean lower low water and the bottom of the bay. |
| Beneficial uses | "Beneficial uses" of the waters of the state that may be protected against quality degradation include but are not limited to, domestic, municipal, agricultural and industrial supply; power generation; recreation; esthetic enjoyment; navigation; and preservation and enhancement of fish, wildlife, and other aquatic resources or preserves. [Cal. Water Code Sec. 13050(f)] |
| Benthos | The whole assemblage of plants or animals living on the bottom of a water body: distinguished from plankton. |
| Best management practices | A practice, or combination of practices, that is determined after ...problem assessment, examination of alternative practices, and appropriate public participation to be the most effective, practicable (including technological, economic, and institutional considerations) means of |

BAY-DELTA HEARING
WATER QUALITY CONTROL PLAN

GLOSSARY

| WORD/PHRASE | DEFINITION |
|--|---|
| | preventing or reducing the amount of pollution generated by nonpoint sources to a level compatible with water quality goals. [40 CFR] |
| Biota | All living organisms that exist in an area. |
| Bloom | A proliferation of algae and/or higher aquatic plants in a body of water. |
| Carriage Water | The amount of Delta outflow needed to meet all of the water quality requirements of D-1485 less (minus) that needed to meet the requirements excluding those for Contra Costa Canal at Pumping Plant No. 1 (D5) and Clifton Court Forebay Intake at West Canal (C9). The quantity of additional Delta outflow (carriage water) is a function of Delta export pumping and south Delta inflow rates. It is necessary to reduce the effects of sea water intrusion into the Delta around the south side of Sherman Island (reverse flows up the San Joaquin River). This definition differs from that used by others in that it does not include additional Delta outflow which may be needed to meet certain contractual obligations of the Department of Water Resources. |
| Chloride (Cl) | The ionic form of the gaseous element chlorine, usually found as a metallic salt with potassium or sodium (SWRCB Order no. W.Q. 85-1). |
| Coagulation | A clumping of particles in water or wastewater which may result in the settling out of suspended materials. often induced by the addition of chemicals such as lime or alum, or a change in the dissolved ions in a water body such as that which occurs in an estuary when the fresh water inflow mixes with intruding seawater (i.e., in the entrapment zone). |
| Conservative constituent (or property) | A constituent (or property) the concentration of which is not effected by chemical or biological processes. [T, XLV, 5:16-5:25] |
| Current flow conditions | Flow conditions as they exist at present. The factors considered when defining flow conditions include: land and water use patterns, reservoir capacities and operating rules, channel configurations, diversion point locations and capacities, etc. Hydrologic investigations typically impose various sets of flow conditions upon the available "hydrologic record" and analyze the resultant effects. Within this Plan current flow conditions are those used by |

BAY-DELTA HEARING
WATER QUALITY CONTROL PLAN

GLOSSARY

| WORD/PHRASE | DEFINITION |
|----------------------------------|--|
| | the Department of Water Resources to produce the results from their 1990 level of development Operations Study (e.g., DWR Exhibit 30). The DWR Operations Study used the hydrologic record for WY 1922 through 1978. |
| DAYFLOW | A Department of Water Resources flow accounting model used to calculate daily Delta outflow at Chipps Island. It also estimates interior Delta flows at specified locations, and fish-related parameters and indices. |
| Delta | The Sacramento-San Joaquin rivers delta as defined in the California Water Code Section 12220. |
| Delta Channel Depletion | The diversions of Delta channel waters via pumps, siphons, and subsurface seepage onto the Delta uplands and lowlands for consumptive use by agriculture and native plants. |
| Dissolved oxygen (DO) | A measure of the amount of oxygen available for biochemical activity in a given amount of water. Adequate levels of DO are needed to support aquatic life. Low dissolved oxygen concentrations can result from inadequate waste treatment (Environmental Glossary 4th ed.). |
| Edmonston, A.D. Pumping Plant | The Department of Water Resources State Water Project (SWP) pumping plant located at the south end of the San Joaquin Valley. The prime mover for all SWP water used south of the Tehachapi Mountains, in Southern California. |
| Electrical Conductivity (EC) | Measures in milli- or micro- mhos, or milliSiemens per centimeter (mmhos/cm, umhos/cm or dS/cm, resp.). The ability of a particular parcel of water to conduct electricity. The EC of a water sample is an indirect measure of the total dissolved solids (TDS) or salinity levels of a water sample (i.e., the higher the EC the greater the TDS). |
| Entrainment | Direct entrainment occurs when fish are actually pulled along with water into a diversion structure because of strong currents created by pumps. Indirect entrainment is caused by the transport of eggs or larve into less desirable areas because of induced flows in channels surrounding diversion structures. |
| Entrapment Zone | An area in an estuary where suspended materials (including certain biota) accumulate. Net upstream transport of the particulate materials that settle into the bottom density current is nullified by the net downstream transport of materials in the river inflow. As a result, certain suspended materials concentrate in the area where the bottom currents are nullified (see Null Zone). [USBR, 112, xi] |

BAY-DELTA HEARING
WATER QUALITY CONTROL PLAN

GLOSSARY

| WORD/PHRASE | DEFINITION |
|---------------------------|---|
| Escapement | The number of adult salmon escaping harvest and returning to the spawning grounds. |
| Estuary | The mouth of a stream which serves as a mixing zone for fresh and ocean water. Mouths of streams which are temporarily separated from the ocean by sandbars are considered as estuaries by the SWRCB. Estuarine waters are generally considered to extend from a bay or the open ocean to a point upstream where there is no significant mixing of fresh water and seawater. Estuarine waters are considered to extend seaward if significant mixing of fresh and seawater occurs in the open coastal waters (SWRCB, Water Quality Control Policy for the Enclosed Bays and Estuaries of California, May 1974). |
| Evapotranspiration | The quantity of water transpired (given off) and evaporated from plant tissue and surrounding soil surfaces. |
| Flushing | The process by which contaminant concentrations in a body of water are diluted by river inflow and, where applicable, tidal exchange of "new" uncontaminated water combined with the net advection of the contaminants away from their source by residual currents. |
| Food chain | The pyramidal relationship of producers (plants) and consumers (animals) by which solar energy is converted through photosynthesis to plant tissue which is consumed by animals which are in turn consumed. At each step up the food chain consumers are usually larger but fewer in number. |
| Fry | The stage in the life of a fish between the hatching of the egg and the absorption of the yolk sac (same as sac fry or alevin). From this stage until they attain a length of one inch the young fish are considered advanced fry. (Bell, M.C., Fisheries Handbook of Engineering Requirements and Biological Criteria, U.S. COE, 1986) |
| Geometric Mean | The antilogarithm of the mean of a group of logarithms of a measured variable. The geometric mean is used to transform logarithmically distributed numbers for statistical purposes. (See definitions for Logarithm and Logarithmic Distribution.) |
| Grab sample | A single sample taken at an instant in time to represent the conditions at that instant. |
| Gravitational Circulation | Net internal motions caused by horizontal density gradients. The denser fluid flows along the bottom and lighter fluid |

BAY-DELTA HEARING
WATER QUALITY CONTROL PLAN

GLOSSARY

| WORD/PHRASE | DEFINITION |
|--------------------------|---|
| | along the surface in an attempt to restore a stable vertical stratification. In the case of a longitudinal salinity gradient, this produces a net landward bottom current and compensating seaward current of fresher water at the surface. Also referred to as Baroclinic Circulation. (Also see Null Zone.) |
| Gravitational Overturn | The formation of a lens of fresh water on the surface of an estuary during a period of high runoff. Also referred to as Gravitational Overflow. This surface layer can spread beyond the mouth of the estuary into the ocean. |
| Grow-out facilities | Ponds at a hatchery or pumping facility where fish are kept until they are large enough to survive on their own. |
| Gyre | A circular or spiral motion: whirl: revolution. |
| Habitat | The sum of environmental conditions in a specific place that is occupied by an organism, population, or community. |
| Historic Flows | Depending on the context used can mean either (i) those flows before man began influencing river flows (i.e., the Natural Flow), or (ii) the actual flows recorded during a specific period of time in the past. |
| Hydraulics | The branch of physics having to do with the mechanical properties of water and other liquids and with the application of these properties in engineering. |
| Hydrodynamics | The motion and action of water and other liquids, i.e., the dynamics of liquids, and the study thereof. |
| Hydrology | The science of water in nature: its properties, distribution, and behavior. |
| Leaching | The flushing of salts from the soil by the downward percolation of water. |
| Logarithm (Log) | The exponent expressing the power to which a fixed number (the base) must be raised in order to produce a given number (the antilogarithm). The most common logarithms are for the base 10. For example, 3 is the base 10 logarithm of 1,000 -- 100 is the base 10 antilogarithm of 2. |
| Logarithmic Distribution | The distribution of a set of observations of a variable which is limited at its lower end by zero (i.e., cannot have a value of less than zero) but is otherwise unrestrained. The logarithms of the observations of a logarithmically distributed variable are symmetrical about (i.e., 50% above |

BAY-DELTA HEARING
WATER QUALITY CONTROL PLAN

GLOSSARY

| WORD/PHRASE | DEFINITION |
|--------------------------------|---|
| | and 50% below) the logarithm of the geometric mean of the variable. |
| Logarithmic Mean (or Log Mean) | See definition of geometric mean. |
| Lunar Day | The time of rotation of the moon about the earth, 24.84 hours. |
| Manganese (Mn) | A hard, brittle, grayish white metallic element, oxidizing readily and forming an important component of certain alloys, as manganese steel. (Funk & Wagnalls Standard College Dictionary, 1973) |
| Marsh or marshland | A tract of low, wet, soft land; swamp; bog; morass; fen. |
| Natural or True Natural Flow | The embayment and channel flows which existed at the time of the first Spanish exploration of California, i.e., before the Gold Rush. |
| Nickel (Ni) | A hard, ductile, malleable, silver-white metallic element of the iron-cobalt group. |
| Nitrate | An ion composed of one atom of nitrogen bound to three atoms of oxygen. An important plant nutrient. In high concentrations, it can bind to hemoglobin resulting in methemoglobinemia. also refers to salts of the nitrate ion with other ionic substances, usually metals. (SWRCB Order No. WQ 85-1) |
| Non-point Source | <p>SWRCB Definition: Any source of discharge to a surface water body that is not from a point source. [CCWD, 58A, G10]</p> <p>EPA Definition: Causes of water pollution that are not associated with point sources, such as agricultural fertilizer runoff, or sediment from construction. Examples include (i) Agriculturally related non-point sources of pollution including runoff from manure disposal areas, and from land used for livestock and crop production; (ii) Siviculturally related non-point sources of pollution; (iii) Mine-related sources of pollution including new, current and abandoned surface and underground mine runoff; (iv) Construction activity related sources of pollution; (v) Sources of pollution from disposal on land, in wells or in subsurface excavations that affect ground and surface water quality; (vi) Salt water intrusion into rivers, lakes, estuaries and ground water resulting from reduction of fresh water flow from any cause, including</p> |

BAY-DELTA HEARING
WATER QUALITY CONTROL PLAN

GLOSSARY

| WORD/PHRASE | DEFINITION |
|-------------------------|--|
| | irrigation, obstruction, ground water extraction, and diversion; and (vii) Sources of pollution related to hydrologic modifications, including those caused by changes in the movement, flow, or circulation of any navigable waters or ground waters due to construction and operation of dams, levees, channels, or flow diversion facilities. [40 CFR] |
| Null Zone | The region in a partially- or well-mixed estuary where the residual bottom currents are effectively zero. Landward of this point there is a net seaward residual velocity along the bottom caused by river inflow and seaward of the null zone, gravitational circulation produces a net landward transport of denser more saline water along the bottom. The null zone is the theoretical upstream boundary of the entrapment zone. |
| Partially-Mixed Estuary | An estuary in which vertical mixing due to tidal currents is large enough to prevent a distinct vertical density stratification between fresh and seawater but not strong enough to completely remove any vertical variation in density. The northern reach of San Francisco Bay is typical of a partially-mixed estuary. |
| Piscivore | Fish eater. |
| Point source | <p>SWRCB Definition: Any discernible, confined and discrete conveyance, including but not limited to any pipe, ditch, channel, tunnel, conduit, well, discrete fissure, container, rolling stock, concentrated animal feeding operation, or vessel or other floating craft, from which pollutants are or may be discharged. [CCWD, 58A, G11]</p> <p>EPA Definition: The same wording as the SWRCB definition with the addition of an exclusion for return flows from irrigated agriculture. [40 CFR]</p> |
| Potable water | Suitable for drinking (Funk & Wagnalls Standard College Dictionary, 1973). |
| Progressive Wave | A tidally-driven wave which travels along an estuary. This type of wave occurs in long shallow estuaries where there is a significant frictional resistance to the tidal flow and only weak wave reflection at the head of the estuary. The tide in the northern reach of San Francisco Bay travels upstream as a progressive wave. |

BAY-DELTA HEARING
WATER QUALITY CONTROL PLAN

GLOSSARY

| WORD/PHRASE | DEFINITION |
|---|---|
| Pulse Flow | A substantial increase in the flow of water followed by a decrease within a relatively short period of time. |
| Quality of Water | Chemical, physical, biological, bacteriological, radiological, and other properties and characteristics of water which affect its use. [Cal. Water Code Sec. 13050(h)] |
| Recruitment | Addition by reproduction of new individuals to a population. |
| Residual Current | The net transport of a particle averaged over a complete tidal cycle. |
| Riparian | Pertaining to the banks and other terrestrial environs adjacent to water bodies, watercourses, and surface-emergent aquifers (e.g. springs, seeps, oases), whose waters provide soil moisture significantly in excess of that otherwise available through local precipitation. Vegetation typical of this environment is dependent on the availability of excess water. |
| Riparian wetland | A zone which may be periodically inundated by water, characterized by moist soil and associated vegetation; typically bounded on one border by a drier upland and on the other by a freshwater body (SWRCB Order no. W.Q. 85-1). |
| Run | To migrate, especially to move in a shoal in order to spawn (American Heritage Dictionary 4th ed.). |
| Salinity | The total concentration of dissolved ions in water, a conservative property (T, XLV, 5:12-5:25). The salt content of a water (SWRCB Order no. W.Q. 85-1). Usually expressed as ppt (g/l), or ppm (mg/l). |
| Salvage | Those fish diverted away from or removed from screens at intakes to diversion structures and subsequently returned to a water body. |
| San Francisco Bay-Delta Estuary (the Estuary) | San Francisco Bay, the Sacramento-San Joaquin Delta and Suisun Marsh, as defined in Section 29101 of the Cal. Public Resources Code, Sections 6610 and 66611 of the Cal. Government Code, and Section 12220 of the Cal. Water Code, respectively. |
| Selenium (Se) | A non-metallic element chemically resembling sulfur. Essential for animals at trace concentrations, selenium is toxic to animals in deficient or excessive dietary exposure (SWRCB Order no. W.Q. 85-1). |

BAY-DELTA HEARING
WATER QUALITY CONTROL PLAN

GLOSSARY

| WORD/PHRASE | DEFINITION |
|---|---|
| Semidiurnal Tide | A tidal variation consisting of two high and two low tides per lunar day (24.84 hrs). In San Francisco Bay, the cycle typically consists of a high high followed by a low low, a low high, a high low and back to a high high tide. |
| Shoal | A shallow place in any body of water, or an assemblage or multitude; throng (i.e., a school of fish (Funk & Wagnalls Standard College dictionary, 1973). |
| Smolt | An anadromous fish that is physiologically ready to undergo the transition from fresh to salt water; age varies depending on species and environmental conditions. (Bell, M.C., 1986). |
| Standing Wave | A wave which does not travel so the point of maximum amplitude (crest to trough) remains fixed in space. Standing waves occur in an estuary when the resistance to the flow is small. The tide in South Bay is an example of a standing wave. |
| Striped bass index (SBI) | An index of the number of young bass which have survived through their first summer. Young bass are sampled with nets which are most efficient for fish about 1.5 inches in length. Sampling methods are consistent (with respect to location, frequency, technique, etc) so that the number of young striped bass caught may be compared with the catch at various locations year to year. The number of young bass caught by the standard sampling methods allows statistical treatment of data to estimate the abundance of young striped bass and to correlate changes in the number caught with changes in environmental factors. (SWRCB, Final EIR for the 1978 WQCP and D-1485, August 1978) |
| Subsurface agricultural drainage system | A set of tile drains, collectors and, in most cases, one or more sump pumps which are installed in a field to remove water from the root zone of any crops which may be planted. Generally installed in areas with shallow perched water tables. |
| Tidal Prism | The increase in water volume landward of a given cross-section from low tide to high tide. Related to the tidal volume on the ebb and flood tide and the cumulative upstream inflows. |
| Tile drains | A System of clay pipes installed beneath irrigated lands to artificially remove water saturating the soil of the crop root zone by gravity flow. |

BAY-DELTA HEARING
WATER QUALITY CONTROL PLAN

GLOSSARY

| WORD/PHRASE | DEFINITION |
|------------------------------|--|
| Total dissolved solids (TDS) | A measure of the salinity equal to the amount of material remaining after evaporating a water sample at 103 to 105 degrees Celsius (formerly centigrade) for one hour (SWRCB Order no. W.Q. 85-1). |
| Tracy Pumping Plant | The U.S. Bureau of Reclamation Central Valley Project pumping plant in the Delta west of Tracy. The source of the water in the Delta-Mendota Canal. |
| Unimpaired Flow | The embayment and channel flows which would exist in the absence of upstream impoundments and diversions of rainfall or snowmelt runoff, but in the presence of existing channel configurations, both upstream and in the Delta. |
| Water Quality Control Plan | A designation or establishment for the waters within a specified area of (1) beneficial uses to be protected, (2) water quality objectives, and (3) a program of implementation needed for achieving water quality objectives. [Cal. Water Code Sec. 13050(j)] |
| Water Quality Objective | The measureable limits or levels of water quality constituents or characteristics which are established for the reasonable protection of beneficial uses of water or the prevention of nuisance within a specific area and time frame. Factors to be considered in establishing water quality objectives shall include, but not be limited to all of the following: <ul style="list-style-type: none"> (a) past, present, and probable future beneficial uses of water, (b) environmental characteristics of the hydrographic unit under consideration, including the quality of water available thereto, (c) water quality conditions that could reasonably be achieved through the coordinated control of all factors which affect water quality in the area, (d) economic considerations, and (e) the need for developing housing within the region. (California Water Code Section 13050 et seq.) |
| Water Quality Standard | A term used in connection with the federal Clean Water Act which is roughly equivalent to water quality objective, except that a water quality standard also includes a plan of implementation to achieve the standard. |
| Water rights | A form of property rights which give their holder the right to use public waters. During the history of California, a variety of procedures have been in effect by which a person could acquire a water right A summary follows: |

BAY-DELTA HEARING
WATER QUALITY CONTROL PLAN

GLOSSARY

WORD/PHRASE

DEFINITION

Appropriative rights initiated prior to December 19, 1914 - prior to the 1914 statutes which established the present system for appropriating water (taking water and putting it to a use removed from property adjoining the water source) two methods of appropriation existed. Prior to 1872, appropriative rights could be acquired simply by taking water and putting it to beneficial use. In 1872, Sections 1410 through 1422 of the California Civil Code enacted a permissive procedure by which priority of rights could be established as of the date of posting of notice of intention to appropriate water, subject to a show of diligence in carrying out construction of diversion works and actual use of water. Appropriators who did not follow the permissive procedure had priority from the date of actually putting the water to use. Because in an appropriative water rights system, first in priority means first served by available water, considerable advantage attaches to an earlier date of appropriation.

Appropriative rights initiated after December 19, 1914 - an appropriation of water must now comply with provisions of Part Two, Division Two of the California Water Code. The right to use water appropriated under earlier procedures as well as under the current procedure maybe lost by abandonment or non-use.

Riparian rights - an owner of land adjoining a water source has, under common law, the right to use a share of the water available from the source. Only those parcels of land adjoining the source may be served by it under riparian right, unless a nonadjoining parcel was at one time part of a riparian parcel and the riparian right was transferred when the parcel was sold. No priority is established for riparian rights, and all riparian users must share the available supply. Riparian owners have priority of use over all appropriators.

Prescriptive rights - rights obtained when water is taken and put to use for five years even though other rightholders' interests are damaged, if the injured parties take no action in their own defense. California Water Code Section 1225 and State Water Resources Control Board policies have made obtaining secure prescriptive rights essentially impossible since 1914 (SWRCB Order no. W.Q. 85-1).

Watershed

The land area that drains into a body of water (Environmental Glossary 4th ed.).

BAY-DELTA HEARING
WATER QUALITY CONTROL PLAN

GLOSSARY

| WORD/PHRASE | DEFINITION |
|---------------------|---|
| Yearling | An organism that is one year old but has not completed its second year. |
| Young-of-year (YOY) | Fish of other organisms less than one (1) year old. |

ABBREVIATIONS FOR
INFORMATION SOURCES AND CITATIONS

| ABBREVIATION | NAME |
|--------------|--|
| ACH | THE CITIES OF AVENAL, COALINGA & HURON |
| ACWA | AMADOR COUNTY WATER AGENCY |
| AHI | AQUATIC HABITAT INSTITUTE |
| ANTIOCH | THE CITY OF ANTIOCH |
| AWWA | AMERICAN WATER WORKS ASSOCIATION: CALIF.-NEV. SECTION |
| BAAC | BAY AREA AUDUBON COUNCIL |
| BADA | BAY AREA DISCHARGERS ASSOCIATION |
| BALIA | BAY AREA LEAGUE OF INDUSTRIAL ASSOCIATIONS |
| BCDC | SAN FRANCISCO BAY CONSERVATION AND DEVELOPMENT COMMISSION |
| BCF | BUTTE CREEK FARMS |
| BISF | THE BAY INSTITUTE OF SAN FRANCISCO |
| CBE | CITIZENS FOR A BETTER ENVIRONMENT |
| CCCWA | CONTRA COSTA COUNTY WATER AGENCY |
| CCWD | CONTRA COSTA WATER DISTRICT |
| CDWA | CENTRAL DELTA WATER AGENCY |
| CFBF | CALIFORNIA FARM BUREAU FEDERATION |
| CNPS | CALIFORNIA NATIVE PLANT SOCIETY |
| CNRF | CALIFORNIA NATURAL RESOURCES FEDERATION |
| COE | U. S. ARMY CORPS OF ENGINEERS |
| CSPA | CALIFORNIA SPORTFISHING PROTECTION ALLIANCE |
| CVAWU | CENTRAL VALLEY AGRICULTURAL WATER USERS |
| CVPWA | CENTRAL VALLEY PROJECT WATER ASSOCIATION |
| CWA | CALIFORNIA WATERFOWL ASSOCIATION |
| DAWDY | DAVID R. DAWDY |
| DFG | CALIFORNIA DEPARTMENT OF FISH AND GAME |
| DHS | CALIFORNIA DEPARTMENT OF HEALTH SERVICES |
| DTAC | DELTA TRIBUTARY AGENCIES COMMITTEE |
| DWR | CALIFORNIA DEPARTMENT OF WATER RESOURCES |
| EA | EA ENGINEERING, SCIENCE AND TECHNOLOGY, INC. |
| EBMUD | EAST BAY MUNICIPAL UTILITY DISTRICT |
| EBRPD | EAST BAY REGIONAL PARK DISTRICT |
| ECCID | EAST CONTRA COSTA IRRIGATION DISTRICT |
| EDF | ENVIRONMENTAL DEFENSE FUND |
| EPA | U.S. ENVIRONMENTAL PROTECTION AGENCY |
| FAO | FOOD AND AGRICULTURAL ORGANIZATION OF THE UNITED NATIONS |
| FDA | U.S. FOOD AND DRUG ADMINISTRATION |
| GDPUD | GEORGETOWN DIVIDE PUBLIC UTILITY DISTRICT |
| HASTINGS | HASTINGS COLLEGE OF THE LAW |
| JOHNSON | PETER JOHNSON |
| KCWA | KERN COUNTY WATER AGENCY |
| KINGS | KINGS COUNTY STATE WATER PROJECT AGRICULTURAL CONTRACTORS |
| MET | THE METROPOLITAN WATER DISTRICT OF SOUTHERN CALIFORNIA |
| MID | MODESTO IRRIGATION DISTRICT |
| NAPA | THE CITY OF NAPA |
| NAS | NATIONAL ACADEMY OF SCIENCES |
| NDWA | NORTH DELTA WATER AGENCY |
| NMFS | U.S. NATIONAL MARINE FISHERIES SERVICE |

| | |
|----------|---|
| NOAA | U. S. NATIONAL OCEANOGRAPHIC AND ATMOSPHERIC ADMINISTRATION |
| NRDC | NATURAL RESOURCES DEFENSE COUNCIL |
| QWD | OAKLEY WATER DISTRICT |
| PALMDALE | PALMDALE WATER DISTRICT |
| PG&E | PACIFIC GAS & ELECTRIC |
| PICYA | PACIFIC INTER-CLUB YACHT ASSOCIATION |
| PRBO | POINT REYES BIRD OBSERVATORY |
| QED | QED RESEARCH, INC. |
| RD2068 | RECLAMATION DISTRICT NO. 2068 |
| RIC | RICE INDUSTRY COMMITTEE |
| RWQCB_2 | SAN FRANCISCO BAY REGIONAL WATER QUALITY CONTROL BOARD (REGION 2) |
| RWQCB_4 | LOS ANGELES REGIONAL WATER QUALITY CONTROL BOARD (REGION 4) |
| RWQCB_5 | CENTRAL VALLEY REGIONAL WATER QUALITY CONTROL BOARD (REGION 5) |
| RWQCB_7 | COLORADO RIVER BASIN REGIONAL WATER QUALITY CONTROL BOARD (REGION 7) |
| RWQCB_8 | SANTA ANA REGIONAL WATER QUALITY CONTROL BOARD (REGION 8) |
| RWQCB_9 | SAN DIEGO REGIONAL WATER QUALITY CONTROL BOARD (REGION 9) |
| SACTO | THE CITY OF SACRAMENTO |
| SACTOCO | THE COUNTY OF SACRAMENTO |
| SAWPA | SANTA ANA WATERSHED PROJECT AUTHORITY |
| SCLDF | THE SIERRA CLUB LEGAL DEFENSE FUND |
| SDIEGO | SAN DIEGO COUNTY WATER AGENCY AND THE CITY OF |
| SDWA | SOUTH DELTA WATER AGENCY |
| SEHC | SACRAMENTO ENVIRONMENTAL HEALTH COALITION |
| SFBAWUA | SAN FRANCISCO BAY AREA WATER USERS ASSOCIATION |
| SFCC | SAN FRANCISCO COMMONWEALTH CLUB |
| SFEP | EPA'S SAN FRANCISCO ESTUARINE PROJECT |
| SFRISCO | THE CITY AND COUNTY OF SAN FRANCISCO |
| SHELL | SHELL OIL COMPANY |
| SMUD | SACRAMENTO MUNICIPAL UTILITY DISTRICT |
| SRCD | SUISUN RESOURCE CONSERVATION DISTRICT |
| SRWCA | SACRAMENTO RIVER WATER CONTRACTORS ASSOCIATION |
| SWC | STATE WATER CONTRACTORS |
| SWRCB | STATE WATER RESOURCES CONTROL BOARD (STATE BOARD) |
| TIBCEN | THE ROMBERG TIBURON CENTER FOR ENVIRONMENTAL STUDIES |
| TID | TURLOCK IRRIGATION DISTRICT |
| TLBWS | TULARE LAKE BASIN WATER STORAGE DISTRICT |
| TRACY | THE CITY OF TRACY |
| UAC | UNITED ANGLERS OF CALIFORNIA |
| USBR | U. S. BUREAU OF RECLAMATION |
| USDA-SCS | U. S. DEPARTMENT OF AGRICULTURE - SOIL CONSERVATION SERVICE |
| USFDA | U. S. FOOD AND DRUG ADMINISTRATION |
| USFWS | U. S. FISH AND WILDLIFE SERVICE |
| USGS | U. S. GEOLOGICAL SURVEY |
| WACOC | WATER ADVISORY COMMITTEE OF ORANGE COUNTY |
| WESTERN | WESTERN CONSORTIUM FOR THE HEALTH PROFESSIONS, INC. |

MONITORING STATIONS

| MONITORING SITE # | STATION NAME |
|----------------------|--|
| C10 | San Joaquin River near Vernalis |
| C13 | Little Potato Slough at Terminous |
| C19 | City of Vallejo Intake |
| C2 | Sacramento River at Collinsville Road |
| C4 | San Joaquin River at San Andreas Landing |
| C5 | Contra Costa Canal at Pumping Plant #1 |
| C6 | San Joaquin River at Brandt Bridge |
| C7 | San Joaquin River at Mossdale Bridge |
| C8 | Old River at Middle River |
| C9 | Clifton Court Forebay Intake at West Canal |
| CS1 | Cache Slough at Junction Point |
| D10 | Sacramento River @ Chipps Island |
| D12 (near) | Antioch Waterworks Intake on the San Joaquin River |
| D15 | San Joaquin River at Jersey Point |
| D22 | Sacramento River at Emmaton |
| D24 | Sacramento River at Rio Vista Bridge |
| D29 | San Joaquin River at Prisoner's Point |
| DMC1 | Delta Mendota Canal @ Tracy Pumping Plant |
| HRM1 | Middle River at Howard Road Bridge |
| NBA1 | North Bay Aquaduct at Barker Slough |
| P12 | Old River at Tracy Road Bridge (near Tracy) |
| S21 prop. | Chadbourne Slough @ Chadbourne Road (proposed) |
| S33 | Cordelia Slough 500 ft West of Southern Pacific Crossing at Cygnus |
| S35 | Goodyear Slough at Morrow Island Clubhouse |
| S42 | Suisun Slough 300 ft South of Volanti Slough |
| S49 | Montezuma Slough near Beldon Landing |
| S64 | Montezuma Slough at National Steel |
| S75 prop. | Goodyear Slough South of Goodyear Slough Control Structure (proposed) |
| S97 prop. | Cordelia Slough at Cordelia-Goodyear Ditch (proposed) |

LIST OF SYMBOLS AND ABBREVIATIONS

| SYMBOL/ ABBREVIATION | DEFINITION |
|-------------------------|---|
| AF | Acre-Foot = 43,560 cubic feet = 325,900 gallons |
| As | Arsenic |
| BOD | Biochemical oxygen demand |
| CFR | U.S. Code of Federal Regulations |
| COD | Chemical oxygen demand |
| CVP | Central Valley Project |
| Cl- | Chloride ion |
| D-1485 | SWRCB Water Rights Decision 1485 |
| DMC | Delta-Mendota Canal |
| DO | Dissolved oxygen |
| DOI | Delta outflow index |
| EC | Electrical conductivity |
| Estuary | San Francisco Bay-Delta Estuary |
| FSA(s) | Flow study area(s) |
| MAF | Million acre feet |
| MGD | Million(s of) gallons per day |
| MLLW | Mean lower low water |
| Mn | Manganese |
| Ni | Nickel |
| PPD | Pollutant Policy Document |
| SBI | Striped bass index |
| SWP | State Water Project |
| Se | Selenium |
| TAF | Thousand acre feet |
| TDS | Total dissolved (filterable) solids |
| THM | Trihalomethane |
| WQCP | Water Quality Control Plan |
| WY | Water year (October 1 through September 30) |
| YOY | Young-of-year |
| ac | Acre = 43,560 square feet |
| cfs | Cubic feet per second = 448.8 gallons per minute = 1.983 acre-feet per day |
| ft | Foot or feet |
| g/l | Grams per liter |
| gpcd | Gallons per capita per day |
| hr(s) | Hour(s) |
| lb | Pound |
| m | Meter or meters = 3.28 feet |
| mg/l | Milligrams per liter |
| mmhos/cm | Millimhos per centimeter (a measure of electrical conductivity) |
| ppb | Parts per billion (approximately equal to ug/l) |
| ppm | Parts per million (approximately equal to mg/l) |
| ppt | Parts per thousand (approximately equal to g/l) |
| sq. ft. | Square foot or feet |
| sq. mi. | Square mile = 640 acres = 259 hectares |
| ug/l | Micrograms per liter |
| umhos/cm | Micromhos per centimeter |

APPENDIX D

Map of Water Quality Control Stations

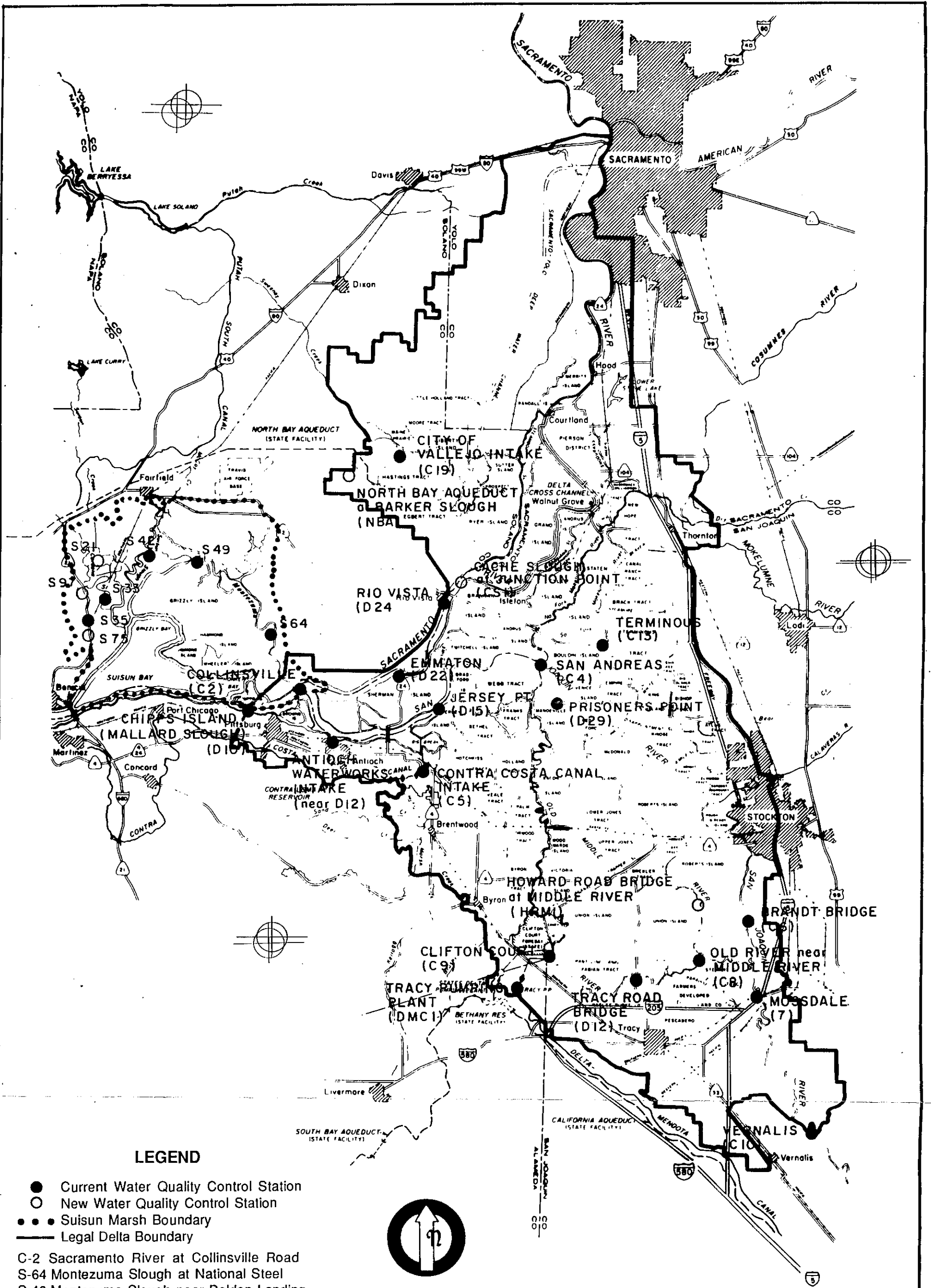

LEGEND

- Current Water Quality Control Station
- New Water Quality Control Station
- Suisun Marsh Boundary
- Legal Delta Boundary

- C-2 Sacramento River at Collinsville Road
- S-64 Montezuma Slough at National Steel
- S-49 Montezuma Slough near Beldon Landing
- S-42 Suisun Slough 300 ft. of Volanti Slough
- S-75 Goodyear Slough South of proposed Goodyear Slough Control Structure
- S-97 Cordelia Slough at Cordelia-Goodyear Ditch
- S-21 Chadbourne Slough at Chadbourne Road
- S-35 Goodyear Slough at Morrow Island Clubhouse
- S-33 Cordelia Slough, 500 ft. West of Southern Pacific crossing at Cygnus



WATER QUALITY CONTROL STATIONS

STATE OF CALIFORNIA
STATE WATER RESOURCES CONTROL BOARD

SACRAMENTO-SAN JOAQUIN DELTA

